

45°

DYNAMIC ABUTMENT SOLUTIONS

DIGITAL solutions



PRODUCT REFERENCE





www.dynamicabutment.com

DYNAMIC ABUTMENT® SOLUTIONS

VIRGINIA WOOLF, 17 · 25005 · LLEIDA (SPAIN)
INTERNATIONAL +34 973 289 580
das@dynamicabutment.com

SPAIN +34 973 289 580
spain@dynamicabutment.com

Dynamic Abutment® Solutions is the trademark of the manufacturer Talladium España S.L

The information included in this catalogue is exclusively addressed to professionals in dental sector.

All commercial trademarks mentioned herein are fully registered by their respective companies, and the images that appear are just to provide an orientation. Talladium reserves the right to modify this document without previous notice. Talladium is not responsible for the inadequate execution of these products if the warning indications corresponding to every reference are not contemplated.

Ask about the products available with CE legislation. Some of the products are not authorized for sale and distribution or do not have a sales license in some countries according to other legislations. Please ask for information: das@dynamicabutment.com



Visit our Online Store to find all our products and compatibilities:

www.dynamicabutmentstore.com

5	<i>LIST OF COMPATIBILITES</i>
6	<i>COMPATIBILITIES AVAILABLE</i>
34	<i>COMPATIBILITY CODES</i>
171	<i>LIBRARY CODES</i>
172	<i>DYNAMIC SCREWS TECHNICAL SPECIFICATIONS</i>
175	<i>DYNAMIC SCREWDRIVER & DYNAMIC SCREWS</i>
176	<i>STRAIGHT SCREWS TECHNICAL SPECIFICATIONS</i>
179	<i>SCREWDRIVERS & STRAIGHT SCREWS</i>
180	<i>DYNAMIC SYSTEM SCANBODIES COLORS ACCCORDING TO COMPATIBILITY</i>
186	<i>DYNAMIC MILLING TOOL SPECIFICATIONS</i>
188	<i>SCREWDRIVER ADAPTOR/COMPLEMENTS</i>
189	<i>IDENTIFICATION PRODUCT/ SECURITY & TRACEABILITY</i>
190	<i>TALLADIUM GUARANTEE</i>

DYNAMIC ABUTMENT® SOLUTIONS

DYNAMIC
DASSYSTEM

DYNAMIC ABUTMENT® SOLUTIONS

MULTI-UNIT
DASSYSTEM

Work different, work better

LIST OF COMPATIBILITIES

AB	BIOTEC	ECKERMANN	IMPLANTSWISS	NORMON	SOLUTIONS
ACE	BRENT MEDICAL	ELITE MEDICA	INTRA-LOCK	NOVA IMPLANTS	TBR
ADIN	BTI	EUROTEKNIKA	JDENTALCARE	OSSTEM IMPLANT	TITANIUM-FIX
ALFA-GATE	BTK	F&B IMPLANT (FIT & BRILLIANT)	KEYSTONE	OSTEOPLUS	TREE-OSS
ALPHABIO	CAMLOG	GALIMPLANT	KLOCKNER	OXY	TRI DENTAL IMPLANTS
ANCLADEN	CONEXÃO SISTEMA DE PROTESE	GC TECH	LASAK	PALTOP	TRINON
ANKYLOS	CORTEX	GLOBAL D (TEKKA)	LEADER	PHIBO	UFIT
ANTHOGRYR	COWELLMEDI	GMI (ILERIMPLANT)	MEDENTIKA	PROCLINIC	VULKAN IMPLANTS
ARDS	C-TECH	GT MEDICAL	MEDENTIS	RADHEX	WIN
ASTRA	DENTAL TECH	HAHN IMPLANT (GLIDEWELL)	MEGAGEN	REFLECT	XIVE
AVINENT	DENTAURUM	HIOSSEN	MICRODENT	SEWON MEDIX	YES IMPLANT
B&W	DENTEGRIS	HI-TEC	MIS	SIC INVENT	ZIACOM
BEGO	DENTIS	IBS	MOZO-GRAU (TICARE)	SIGNO VINCES	ZIMMER
BIOCONCEPT	DENTIUM	IDO IMPLANTS	MPI	SIN IMPLANTS	
BIOGENESIS	DIO IMPLANTS	IHDE DENTAL (IMBIODENT)	NEOBIOTECH	SOUTHERN IMPLANTS	
BIOHORIZONS	DMI DENTAL SUPPLY	IMPLANT DIRECT	NEODENT	STERI-OSS	
BIOLOK	DSP BIOMEDICAL	IMPLANT GENESIS	NEOSS	STERNGOLD	
BIOMET 3i	EASY IMPLANT		NOBEL BIOCARE	STRAUMANN	
BIONER			NORIS MEDICAL	SYBRON IMPLANT	

COMPATIBILITIES AVAILABLE

BRAND	MODEL	IMPLANT Ø	PLATFORM	ROTATION	COMPATIBILITY CODE
AB	I2	3,5/3,75/4,2/4,5/	Standard	R/NR	0040
AB	I2	5/6	Standard	R/NR	0040
AB	I22	3,75/4,22	Standard	R/NR	0040
AB	I5	3,5/3,75/4,2/4,5/	Standard	R/NR	0040
AB	I5	5/6/7/8	Standard	R/NR	0040
AB	I55	3,75/4,2/4,5	Standard	R/NR	0040
AB	I55	5/6/7/8	Standard	R/NR	0040
AB	I10	4,2/5	Standard	R/NR	0040
AB	I15	6/7/8	Standard	R/NR	0040
AB	Multi Unit D1-P64	Multi Unit D1-P64	Universal	R	0025
ACE	External Hex	3,3	NP 3,5	R/NR	0023
ACE	External Hex	3,75/4	RP 4,1	R/NR	0024
ACE	External Hex	4,75	WP 5	R/NR	0058
ACE	Infinity TRI-CAM	3,5	3,5	R/NR	0026
ACE	Infinity TRI-CAM	4,3	4,3	R/NR	0027
ACE	Infinity TRI-CAM	5	5	R/NR	0028
ACE	Infinity Internal Hex	3,7/4,1	3,5	R/NR	0040
ACE	Infinity Internal Hex	4,7/5,1	4,5	R/NR	0041
ACE	Infinity Octagon	3,3	RP 4,8	R/NR	0037
ACE	Infinity Octagon	4,1	RP 4,8	R/NR	0037
ACE	Infinity Octagon	4,8	RP 4,8	R/NR	0037
ACE	Infinity Octagon	4,8	WP 6,5	R/NR	0096
ACE	Multi Unit	Universal	Universal	R	0025
ADIN	Swell	3,3	3,45	R/NR	0040

COMPATIBILITIES AVAILABLE

BRAND	MODEL	IMPLANT Ø	PLATFORM	ROTATION	COMPATIBILITY CODE
ADIN	Swell	3,75/4,2	3,6	R/NR	0040
ADIN	Swell	5	4	R/NR	0040
ADIN	Swell	6	4,6	R/NR	0040
ADIN	Touareg-S / Touareg-OS	3,5	3,45	R/NR	0040
ADIN	Touareg-S / Touareg-OS	3,75/4,2	3,6	R/NR	0040
ADIN	Touareg-S / Touareg-OS	5	4	R/NR	0040
ADIN	Touareg-S / Touareg-OS	6	5	R/NR	0040
ADIN	Touareg CloseFit	2,75	UNP	R/NR	0188
ADIN	Touareg CloseFit	3,5	RP	R/NR	0021
ADIN	Touareg CloseFit	4,3/5	WP	R/NR	0022
ADIN	Swell	3,3	3,45	ZIO	0042
ADIN	Swell	3,75/4,2	3,6	ZIO	0042
ADIN	Swell	5	4	ZIO	0042
ADIN	Swell	6	4,6	ZIO	0042
ADIN	Touareg-S / Touareg-OS	3,5	3,45	ZIO	0042
ADIN	Touareg-S / Touareg-OS	3,75/4,2	3,6	ZIO	0042
ADIN	Touareg-S / Touareg-OS	5	4	ZIO	0042
ADIN	Touareg-S / Touareg-OS	6	5	ZIO	0042
ADIN	Touareg CloseFit	3		R	0145
ADIN	Touareg CloseFit	3	NP	NR	0145
ADIN	Multi Unit TMA	Universal	Universal	R	0025
ALFA-GATE	Bioactive S-line/SLA	3,3/3,75/4,2/4,7/5,2/6	3,75	R/NR	0040
ALFA-GATE	Conical	3,5	NP	R/NR	0021
ALFA-GATE	Conical	4,3/5	RP	R/NR	0022

COMPATIBILITIES AVAILABLE

BRAND	MODEL	IMPLANT Ø	PLATFORM	ROTATION	COMPATIBILITY CODE
ALPHABIO	Internal Hex Connection (IH) SPI	3,3/3,75/4,2/5/6	Universal	R/NR	0040
ALPHABIO	Internal Hex Connection (IH) ICE	3,7/3,75/4,2/4,65/5,3	Universal	R/NR	0040
ALPHABIO	Internal Hex Connection (IH) DFI	3,3/3,75/4,2/5	Universal	R/NR	0040
ALPHABIO	Internal Hex Connection (IH) ATID	3,3/3,75/4,2/5/6	Universal	R/NR	0040
ALPHABIO	Internal Hex Connection (IH) NEO	3,75/4,2/5	3,5	R/NR	0040
ALPHABIO	Conical Hex Connection (CHC) NICE	3,2	Narrow	R/NR	0136
ALPHABIO	Conical Hex Connection (CHC) NEO	3,2/3,5	Narrow	R/NR	0136
ALPHABIO	Conical Standard Connection (CS)	3,75/4,2/5	Standard	R/NR	0169
ALPHABIO	Multi Unit		Universal	R	0195
ANCLADEN	Anclalock	3,75/4,25/5	3,5	R/NR	0040
ANKYLOS	Ankylos	3,5	3,5	R	0075
ANKYLOS	Ankylos	4,5	4,5	R	0075
ANKYLOS	Ankylos	5,5	5,5	R	0075
ANKYLOS	Ankylos	7	7	R	0075
ANKYLOS	Balance Base Narrow	Universal	Universal	R	0183
ANTHOGYR	Axiom REG / PX	3,4	3,4	R/NR	0161
ANTHOGYR	Axiom REG / PX	4	4	R/NR	0149
ANTHOGYR	Axiom REG / PX	4,6	4,6	R/NR	0149
ANTHOGYR	Axiom REG / PX	5,2	5,2	R/NR	0162
ANTHOGYR	Anthofit HE	3,5/3,75/4	R (4,1)	R/NR	0024
ANTHOGYR	Anthofit HE	5	L (5)	R/NR	0058
ANTHOGYR	Ossfit	3,5/4,2	4,8	R/NR	0074
ANTHOGYR	Ossfit	3,5/4,2	4,8	R/NR	0037
ANTHOGYR	Ossfit	5	6,5	R/NR	0096

COMPATIBILITIES AVAILABLE

BRAND	MODEL	IMPLANT Ø	PLATFORM	ROTATION	COMPATIBILITY CODE
ANTHOGYR	Multi Unit	4,8	Universal	R	0163
ARDS	Smart	3,75/4,2/4,5	3,75	R/NR	0040
ARDS	Classic	3,3/3,75/4,2/5/6	3,75	R/NR	0040
ARDS	Premium	3,3/3,75/4,2/5/6	3,75	R/NR	0040
ARDS	CIT	3,3/3,75/4,2/5/6	3,75	R/NR	0040
ASTRA	Yellow	3	Yellow (X-estrecha)	R/NR	0109
ASTRA	Aqua	3,5/4	Aqua(Estrecha)	R/NR	0004
ASTRA	Lilac	4,5/5	Lilac (Ancha)	R/NR	0005
ASTRA	Evolution (Interno)	3	3.0	R/NR	0090
ASTRA	Evolution (Interno)	3,6	3.6	R/NR	0006
ASTRA	Evolution (Interno)	4,2	4.2	R/NR	0007
ASTRA	Evolution (Interno)	4,8	4.8	R/NR	0091
ASTRA	Evolution (Interno)	5,4	5.4	R/NR	0092
ASTRA	Uniabutment Cono 20o	Regular/Wide	Regular/Wide	R	0066
ASTRA	Evolution (Cono externo 33°)		Universal	R	0008
ASTRA	Multibase Abutment (SmartFix concept)		Universal	R	0258
AVINENT	HE/EC	3,3//3,5/4	3,5	R/NR	0023
AVINENT	HE/EC	3,3/3,8/4/4,2/4,8//4,5/5	4,1	R/NR	0024
AVINENT	HE/EC	4,8	5,1	R/NR	0061
AVINENT	HI/IC	3,1//3,5/4	3,5	R/NR	0040
AVINENT	HI/IC	3,3/3,8/4/4,2/4,8//4,5/5	4,1	R/NR	0040
AVINENT	Transepitelial		Regular	R	0025
B&W	Hexágono Externo	3,75/4	4,1	R/NR	0024
B&W	Hexágono Externo	5	5	R/NR	0058

COMPATIBILITIES AVAILABLE

BRAND	MODEL	IMPLANT Ø	PLATFORM	ROTATION	COMPATIBILITY CODE
B&W	Cónico Hexagono Interno CIH	3,3/4		ZIO	0042
B&W	Cónico Hexagono Interno CIH	3,3/4		R	0040
BEGO	RS/RSX	3.0		R/NR	0049
BEGO	S/RI/RS/RSX	3,25/3,75		R/NR	0050
BEGO	S/RI/RS/RSX	4,1		R/NR	0051
BEGO	S/RI/RS/RSX	4,5		R/NR	0052
BEGO	S/RI/RS/RSX	5,5		R/NR	0081
BEGO	Mini	2,7/2,9/3,1		Mini	0187
BEGO	MultiPlus			Universal	0150
BIOCONCEPT	BC Tissue Level Standard	3,3/4,1/4,8		Regular	R/NR
BIOCONCEPT	BC Tissue Level Standard Plus	4,8		Regular	R/NR
BIOCONCEPT	BC Tissue Level Tapered Effect	4,8		Regular	R/NR
BIOCONCEPT	BC Bone Level	3,3		Narrow	R/NR
BIOCONCEPT	BC Bone Level	4,1/4,8		Regular	R/NR
BIOCONCEPT	BV Tapered Bone Level	3,5		Narrow	R/NR
BIOCONCEPT	BV Tapered Bone Level	4/4,5/5		Regular	R/NR
BIOGENESIS	3icon	3,3		Mini (Pink)	R/NR
BIOGENESIS	3icon	3,75/4/4,3/4,5		Regular (Blue)	R/NR
BIOGENESIS	3icon	5/5,5		Wide (Yellow)	R/NR
BIOGENESIS	Aticon	3,5/4/4,5/5		Blue	R/NR
BIOGENESIS	Iticon	3,5/4,1/4,8		4,8	R/NR
BIOHORIZONS	External	3,5		3,7 (Yellow)	R/NR
BIOHORIZONS	Tapered Internal	3,8		3,5 (Yellow)	R/NR
BIOHORIZONS	Tapered Internal	4,6		4,5 (Green)	R/NR

COMPATIBILITIES AVAILABLE

BRAND	MODEL	IMPLANT Ø	PLATFORM	ROTATION	COMPATIBILITY CODE
BIOHORIZONS	Tapered Internal	5,8		5,7 (Blue)	R/NR
BIOHORIZONS	Tapered Plus	4,6		3,5 (Yellow)	R/NR
BIOHORIZONS	Tapered Plus	5,8		4,5 (Green)	R/NR
BIOHORIZONS	Mount-free Tapered Internal	3,8		3,5 (Yellow)	R/NR
BIOHORIZONS	Mount-free Tapered Internal	4,6		4,5 (Green)	R/NR
BIOHORIZONS	Mount-free Tapered Internal	5,8		5,7 (Blue)	R/NR
BIOHORIZONS	Tapered Pro	4,2/4,6		3,5 (Yellow)	R/NR
BIOHORIZONS	Tapered Pro	5,2		4,5 (Green)	R/NR
BIOHORIZONS	Tapered Short	4,6		3,5 (Yellow)	R/NR
BIOHORIZONS	Tapered Short	5,8		4,5 (Green)	R/NR
BIOHORIZONS	Tapered PTG	4,2		3,5 (Yellow)	R/NR
BIOHORIZONS	Tapered IM (Immediate Molar)	7/8		5,7 (Blue)	R/NR
BIOHORIZONS	Tapered Tissue Level	3/3,8		3,5 (Yellow)	R/NR
BIOHORIZONS	Tapered Tissue Level	4,6		4,5 (Green)	R/NR
BIOHORIZONS	Tapered Tissue Level	5,8		5,7 (Blue)	R/NR
BIOHORIZONS	Multi Unit			Universal	R
BIOLOK	Hexágono Externo	3,45		3,45	R/NR
BIOMET 3i	Osseotite External Hex	3,25		3,4	R/NR
BIOMET 3i	Osseotite External Hex	3,75/4		4,1	R/NR
BIOMET 3i	Osseotite External Hex	5		5	R/NR
BIOMET 3i	Certain	3,25/4		3,4	R/NR
BIOMET 3i	Certain	4/5		4,1	R/NR
BIOMET 3i	Certain	5		5	R/NR
BIOMET 3i	Low Profile			Universal	R

COMPATIBILITIES AVAILABLE

BRAND	MODEL	IMPLANT Ø	PLATFORM	ROTATION	COMPATIBILITY CODE
BIONER	Ikelt / Bikelt	3,3/3,75/4	4,1	R/NR	0024
BIONER	Ikelt	5	5	R/NR	0058
BIONER	Hikelt	3,8	3,95	R/NR	0040
BIONER	Hikelt	4,7	4,9	R/NR	0041
BIONER	TopDM	3,5	3,5	R/NR	0021
BIONER	TopDM	4	4	R/NR	0021
BIONER	TopDM	5	5	R/NR	0021
BIONER	Transepitelial A-5M	Transepitelial A-5M	Regular	R	0025
BIOTEC	SPR/CIM	3,75	3,75	R/NR	0040
BIOTEC	SPR/SPTT/CIM	4,2	4,2	R/NR	0040
BIOTEC	SPR/SPTT/CIM	5	5	R/NR	0040
BIOTEC	SPR/CIM	3,3	3,3	NR	0040
BIOTEC	SPR/CIM	3,3	3,3	R	0040
BREDENT MEDICAL	Narrow Sky	3,5	NP 3,5	R/NR	0110
BREDENT MEDICAL	Blue Sky	3,5/4/4,5/5,5	4	R/NR	0111
BREDENT MEDICAL	Blue Sky Classic	3,5/4/4,5	4	R/NR	0111
BREDENT MEDICAL	Copa Sky	3,5/4/4,5/5/6	3,3	R/NR	0251
BTI	Externa Tiny	2,5/3/3,3/3,5/3,75	Tiny 3,5	R/NR	0009
BTI	Externa Universal	3,75/4	Universal 4,1	R/NR	0024
BTI	Externa Universal Plus	4,5/5	Universal Plus 4,1	R/NR	0024
BTI	Externa	4,5/5/5,5	Ancha 5,5	R/NR	0060
BTI	Interna Universal	3,3/3,5/3,75/4/4,25	Universal 4,1	R/NR	0010
BTI	Interna Universal Plus	4,5/5/5,5	Universal Plus 4,1	R/NR	0010
BTI	Interna Ancha	5,5/6/6,25	Ancha 5,5	R/NR	0059

COMPATIBILITIES AVAILABLE

BRAND	MODEL	IMPLANT Ø	PLATFORM	ROTATION	COMPATIBILITY CODE
BTI	Multi-IM	converter 4,1	Universal 4,1	R	0151
BTK	Klassic / Konic	3,25	3,4 EN	R/NR	0003
BTK	Klassic / Konic	3,25PL/3,75/4	4,1 ER	R/NR	0024
BTK	IS +	3,3/3,7/4,1/4,8/6	DR	R/NR	0029
BTK	BT Safe BL	3,3/3,7/4,1/4,8	KR	R/NR	0029
BTK	Klassic / Konic	3,25/4	3,5 IR	R/NR	0040
BTK	Klassic / Konic	3,25/4	3,5 IR	ZIO	0042
CAMLOG	Camlog Screw-Line/Progressive-Line	3,3	3,3	R/NR	0087
CAMLOG	Camlog Screw-Line/Progressive-Line	3,8	3,8	R/NR	0011
CAMLOG	Camlog Screw-Line/Progressive-Line	4,3	4,3	R/NR	0012
CAMLOG	Camlog Screw-Line/Progressive-Line	5	5	R/NR	0088
CAMLOG	Camlog Screw-Line/Progressive-Line	6	6	R/NR	0089
CAMLOG	Conelog Screw-Line/Progressive-Line	3,3	3,3	R/NR	0119
CAMLOG	Conelog Screw-Line/Progressive-Line	3,8	3,8	R/NR	0120
CAMLOG	Conelog Screw-Line/Progressive-Line	4,3	4,3	R/NR	0121
CONEXÃO SISTEMA DE PRÓTESE	Flash	3,5/4,3/5	Universal	R/NR	0021
CONEXÃO SISTEMA DE PRÓTESE	Torq	3,5/3,75/4	Universal	R/NR	0021
CONEXÃO SISTEMA DE PRÓTESE	Expand	3,75/4/5	Universal	R/NR	0021
CORTEX	Internal Hex Dynamix	3,3/3,8/4,2/5/6	3,75	R/NR	0040
CORTEX	Internal Hex Classix	3,3/3,8/4,2/5/6	3,75	R/NR	0040
CORTEX	Internal Hex Saturn	3,8/4,2	3,5	R/NR	0040
CORTEX	Conical Dynamix	3	NP	R/NR	0109
CORTEX	Conical Dynamix	3,3/3,8/4,2	RP	R/NR	0004
CORTEX	Conical Dynamix	5/6	WP	R/NR	0005

COMPATIBILITIES AVAILABLE

BRAND	MODEL	IMPLANT Ø	PLATFORM	ROTATION	COMPATIBILITY CODE
CORTEX	Conical Classix	3,3/3,8/4,2	RP	R/NR	0004
CORTEX	Conical Classix	5/6	WP	R/NR	0005
CORTEX	Conical Magix	3,3/3,8/4,2	RP	R/NR	0004
CORTEX	Multi Unit		Universal	R	0025
COWELLMEDI	Inno - External Type	5,0/6,0	5,1	R/NR	0061
COWELLMEDI	Multi S&A Abutment Ø 4,5 mm	Multi S Abutment	Universal	R	0193
C-TECH	EL Esthetic Line	3,8/4,3/5,1	4	R/NR	0246
C-TECH	Multi Unit		Universal	R	0245
DENTAL TECH	Implogic	4,5	4,5 (Blue)	R/NR	0041
DENTAURUM	Tiologic	3,3	Small	R/NR	0130
DENTAURUM	Tiologic	3,7/4,2	Medium	R/NR	0131
DENTAURUM	Tiologic	4,8/5,5	Large	R/NR	0132
DENTEGRIS	SLS-Straight	4,5	4,5	R/NR	0041
DENTEGRIS	Sinus-Lift	4,5	4,5	R/NR	0041
DENTEGRIS	S&T Implants	4,5	4,5	R/NR	0041
DENTIS	OneQ-SL	3	Narrow	R/NR	0014
DENTIS	OneQ-SL	3,9/4,2/4,7/5,2	Regular	R/NR	0030
DENTIS	OneQ-SL	6/7/8	Wide	R/NR	0030
DENTIS	s-Clean Tapered / Tapered II	3,7	Mini	R/NR	0030
DENTIS	s-Clean Tapered / Tapered II	4,1/4,3	Regular	R/NR	0030
DENTIS	s-Clean Tapered / Tapered II	4,8	Wide	R/NR	0030
DENTIS	s-Clean Straight	4,1/4,8	4,1/4,8	R/NR	0030
DENTIS	s-Clean Save	5,5/6	5,5/6	R/NR	0030
DENTIS	SQ-SL	3,5	Narrow	R/NR	0014

COMPATIBILITIES AVAILABLE

BRAND	MODEL	IMPLANT Ø	PLATFORM	ROTATION	COMPATIBILITY CODE
DENTIS	SQ-SL	4/4,5/5	Regular	R/NR	0030
DENTIS	SQ-SL	6/7/8	Wide	R/NR	0030
DENTIS	e-Clean	3,5	Mini	R/NR	0023
DENTIS	e-Clean	4,1	Regular	R/NR	0024
DENTIS	e-Clean	5,1	Wide	R/NR	0061
DENTIS	i-Clean Tapered	3,7	Mini	R/NR	0037
DENTIS	i-Clean Tapered	4,1/4,3	Regular	R/NR	0037
DENTIS	i-Clean Tapered	4,8	Wide	R/NR	0037
DENTIS	i-Clean Straight	4,1/4,8	4,8	R/NR	0037
DENTIS	Octa Abutment	Universal	Universal	R/NR	0074
DENTIUM	NR Line	3,1	3,2	R/NR	0190
DENTIUM	NR Line	3,1	3,6	R/NR	0190
DENTIUM	NR Line	3,6	3,6	R/NR	0191
DENTIUM	NR Line	4,3	4,3	R/NR	0191
DENTIUM	NR Line	5	5	R/NR	0191
DENTIUM	NR Line	6	6	R/NR	0191
DENTIUM	SimpleLine II	3,8/4,3	4,8	R/NR	0074
DENTIUM	SimpleLine II	3,8/4,3	4,8	R/NR	0037
DENTIUM	SimpleLine II	4,3/4,8	6,5	R/NR	0096
DENTIUM	SuperLine and Implantium	3,4	3,6	R/NR	0030
DENTIUM	SuperLine and Implantium	3,8	4	R/NR	0030
DENTIUM	SuperLine and Implantium	4,3	4,5	R/NR	0030
DENTIUM	SuperLine and Implantium	4,8	5	R/NR	0030
DENTIUM	SuperLine and Implantium	4,8	6	R/NR	0030

COMPATIBILITIES AVAILABLE

BRAND	MODEL	IMPLANT Ø	PLATFORM	ROTATION	COMPATIBILITY CODE
DENTIUM	Multi Unit NR Line		5	R	0192
DENTIUM	Multi Unit Superline and Implantium		4,5	R	0193
DIO IMPLANTS	SM System	4,5/5/5,3	Regular/Wide	R/NR	0013
DIO IMPLANTS	UF II Narrow	3/3,3	Narrow	R/NR	0014
DIO IMPLANTS	UF II	3,8/4/4,5/5/5,5	Regular	R/NR	0030
DIO IMPLANTS	External	3,3/3,8	Narrow 3,5	R/NR	0023
DIO IMPLANTS	External	3,75/4/4,5	Regular 4,1	R/NR	0024
DIO IMPLANTS	External	5/5,3/5,5/6	Wide 5,1	R/NR	0061
DIO IMPLANTS	Internal OCTA		4.8	R/NR	0074
DIO IMPLANTS	Multi Unit		Universal	R	0247
DMI DENTAL SUPPLY	DCI/DSI	3,3/3,5/3,75/4,2/5/6	3,75	R/NR	0040
DSP BIOMEDICAL	Hexágono Externo	3,75/4/5//3,5/3,8/4,3	4,1	R/NR	0024
EASY IMPLANT	Master C	3,5	3,5 (Ocean)	R/NR	0004
EASY IMPLANT	Master C	4	4 (Ocean)	R/NR	0004
EASY IMPLANT	Master C	4,5	4,5 (Lilas)	R/NR	0030
EASY IMPLANT	Master C	5	5 (Lilas)	R/NR	0030
EASY IMPLANT	Master S	3,3	3,3 (Ocean)	R/NR	0004
EASY IMPLANT	Master S	3,75	3,75 (Lilas)	R/NR	0030
EASY IMPLANT	Master S	4,25	4,25 (Lilas)	R/NR	0030
EASY IMPLANT	Master S	4,75	4,75 (Lilas)	R/NR	0030
EASY IMPLANT	Master L	3,3	3,3 (Lilas)	R/NR	0030
EASY IMPLANT	Master L	3,75	3,75 (Lilas)	R/NR	0030
EASY IMPLANT	Master L	4,25	4,25 (Lilas)	R/NR	0030
EASY IMPLANT	Master L	4,75	4,75 (Lilas)	R/NR	0030

COMPATIBILITIES AVAILABLE

BRAND	MODEL	IMPLANT Ø	PLATFORM	ROTATION	COMPATIBILITY CODE
EASY IMPLANT	Hexcel-S	3,3	3,3	R/NR	0003
EASY IMPLANT	Hexcel-S	3,75	4,1	R/NR	0024
EASY IMPLANT	Hexcel-S	4,25	4,1	R/NR	0024
EASY IMPLANT	Hexcel-S	4,75	5	R/NR	0058
EASY IMPLANT	MINI	3	3	NR	0176
EASY IMPLANT	Multi Unit Conical Abutment		Universal	R	0025
ECKERMANN	Hexagon	3/3,5/4/4,5/5	4,1	R/NR	0024
ECKERMANN	Winner	3/3,5/4	3,5	R/NR	0040
ECKERMANN	Winner	4/4,5/5	4,5	R/NR	0041
ECKERMANN	Winner	3/3,5/4	3,5	ZIO	0042
ECKERMANN	Winner	4/4,5/5	4,5	ZIO	0043
ELITE MEDICA	Conexión Externa	3,75	Narrow	R/NR	0023
ELITE MEDICA	Conexión Externa	4	Regular	R/NR	0024
ELITE MEDICA	Conexión Externa	5	Wide	R/NR	0061
EUROTEKNIKA	Naturactis	3,5	3,4	R/NR	0004
EUROTEKNIKA	Naturactis	4	3,8	R/NR	0004
EUROTEKNIKA	Naturactis	4,5	4,3	R/NR	0004
EUROTEKNIKA	Naturactis	5	4,8	R/NR	0004
EUROTEKNIKA	Uneva	3,6	4,1	R/NR	0024
EUROTEKNIKA	Uneva	4,1	4,1	R/NR	0024
EUROTEKNIKA	Uneva (Platform Switching)	4,8	4,1	R/NR	0024
EUROTEKNIKA	Uneva (Platform Switching)	6	4,1	R/NR	0024
EUROTEKNIKA	Natea	3,6/4,1/4,8	Narrow	R/NR	0004
EUROTEKNIKA	Natea	3,6/4,1/4,8	Regular	R/NR	0004

COMPATIBILITIES AVAILABLE

BRAND	MODEL	IMPLANT Ø	PLATFORM	ROTATION	COMPATIBILITY CODE
EUROTEKNIKA	Natea	6	Wide	R/NR	0004
EUROTEKNIKA	Aesthetica	4,1	4,8	R/NR	0074
EUROTEKNIKA	Aesthetica	4,1	4,8	R/NR	0037
EUROTEKNIKA	Aesthetica	4,8	6,5	R/NR	0096
EUROTEKNIKA	Naturall	3,5	Narrow	R/NR	0004
EUROTEKNIKA	Naturall	4/4,5	Regular	R/NR	0004
EUROTEKNIKA	Naturall	5	Wide	R/NR	0004
EUROTEKNIKA	Multi Unit Tetra	Universal	Universal	R	0025
F&B IMPLANT (FIT & BRILLIANT)	FA Submerged Fixture	3,9	Narrow	R/NR	0030
F&B IMPLANT (FIT & BRILLIANT)	FA Submerged Fixture	4,1/4,4	Regular	R/NR	0030
F&B IMPLANT (FIT & BRILLIANT)	FA Submerged Fixture	4,8	Wide	R/NR	0030
F&B IMPLANT (FIT & BRILLIANT)	FA Submerged Fixture	5,3/5,8/6,3/6,8	Ultra-Wide	R/NR	0030
GALIMPLANT	Conexión Externa	3,5/4	4	R/NR	0024
GALIMPLANT	Conexión Interna	3,5	3,5	R/NR	0004
GALIMPLANT	Conexión Interna	4	4	R/NR	0004
GALIMPLANT	Conexión Interna	5	5	R/NR	0004
GALIMPLANT	Pilar multi-posicion recto/Pilar multi-posicion angulado	Universal	Universal	R	0025
GC TECH	AADVA Standard / Tapered Implants	3,3	Narrow	R/NR	0196
GC TECH	AADVA Standard / Tapered Implants	4	Regular	R/NR	0197
GC TECH	AADVA Standard / Tapered Implants	5	Wide	R/NR	0198
GLOBAL D (TEKKA)	In-Kone Universal	3,5/4/4,5/5	Universal	R/NR	0152
GLOBAL D (TEKKA)	In-Kone Primo	3,5/4/4,5/5	Universal	R/NR	0152
GMI (ILERIMPLANT)	Phoenix	3,3/3,75/4	Standard 4,1	R/NR	0024
GMI (ILERIMPLANT)	Phoenix	5	Wide 5,1	R/NR	0061

COMPATIBILITIES AVAILABLE

BRAND	MODEL	IMPLANT Ø	PLATFORM	ROTATION	COMPATIBILITY CODE
GMI (ILERIMPLANT)	Frontier	3,3/3,75/4,25	RP 3,3	R/NR	0040
GMI (ILERIMPLANT)	Frontier	4,75/5,75	WP 4,3	R/NR	0041
GMI (ILERIMPLANT)	Universal	Universal	PS-RP 4,8	R	0025
GT MEDICAL	Best Fit Octógono Interno	3,7/4,3/4,8	Regular	R/NR	0074
GT MEDICAL	Best Fit Octógono Interno	3,7/4,3/4,8	Regular	R/NR	0037
GT MEDICAL	Best Fit Hexágono Interno	3,7/4,1/4,3/4,8	Wide	R/NR	0005
GT MEDICAL	Best Fit Hexágono Externo	3,5	Narrow	R/NR	0023
GT MEDICAL	Best Fit Hexágono Externo	4,1	Regular	R/NR	0024
GT MEDICAL	Best Fit Hexágono Externo	5,1	Wide	R/NR	0061
HAHN IMPLANT (GLIDEWELL)	Hahn Tapered Implant	3,5/4,3	3,5/4,3	R/NR	0021
HAHN IMPLANT (GLIDEWELL)	Hahn Tapered Implant	5	5	R/NR	0022
HAHN IMPLANT (GLIDEWELL)	Hahn Tapered Implant	7	7	R/NR	0124
HAHN IMPLANT (GLIDEWELL)	Multi-Unit Abutment system	Universal	Universal	R	0025
HIOSEN	ETII SA / ETIII SA	3,5	Mini	R/NR	0029
HIOSEN	ETII SA / ETIII SA / ETIV SA	4/4,5/5	Regular	R/NR	0030
HIOSEN	ETIII BA	3,5	Mini	R/NR	0029
HIOSEN	ETIII BA	4/4,5/5	Regular	R/NR	0030
HI-TEC	Tapered Self Thread	3,3/3,75	3,5	R/NR	0040
HI-TEC	Tapered Self Thread	4,2/5	4,5	R/NR	0041
HI-TEC	Logic Plus	3,5	3,7	R/NR	0040
HI-TEC	Logic Plus	4,3	3,9	R/NR	0040
IBS	Magic FC	4/4,5/5/5,5/6/6,5	3,8	R/NR	0030
IBS	N.R. Fix	3/3,5	3,8	R/NR	0030
IDO IMPLANTS	I Do Implant	3,8/4/4,5/5/5,5/6/7	Universal	R/NR	0030

COMPATIBILITIES AVAILABLE

BRAND	MODEL	IMPLANT Ø	PLATFORM	ROTATION	COMPATIBILITY CODE
IHDE DENTAL (IMBIODENT)	Bone Level Plus	3,3	3,3	R/NR	0033
IHDE DENTAL (IMBIODENT)	Bone Level Plus	4,1	4,1	R/NR	0035
IHDE DENTAL (IMBIODENT)	Bone Level Plus	4,8	4,8	R/NR	0035
IMPLANT DIRECT	RePlus / Replant / Reactive	3,5/3,7/4,2	3,5	R/NR	0026
IMPLANT DIRECT	RePlus / Replant / Reactive	4,3/4,7	4,3	R/NR	0027
IMPLANT DIRECT	RePlus / Replant / Reactive	5/5,7	5	R/NR	0028
IMPLANT DIRECT	Legacy	3,7/4,2	3,5	R/NR	0040
IMPLANT DIRECT	Legacy	4,7/5,2	4,5	R/NR	0041
IMPLANT DIRECT	Swishplant / Swishplus	4,1/4,8	4,8	R/NR	0074
IMPLANT DIRECT	Swishplant / Swishplus	4,1/4,8	4,8	R/NR	0037
IMPLANT DIRECT	Swishplant / Swishplus	4,8/5,7	6,5	R/NR	0096
IMPLANT DIRECT	SwishActive	3,3	3	R/NR	0021
IMPLANT DIRECT	SwishActive	4,1/4,8	3,4	R/NR	0022
IMPLANT DIRECT	Interactive	3,2/3,7	3	R/NR	0021
IMPLANT DIRECT	Interactive	4,3/5	3,4	R/NR	0022
IMPLANT DIRECT	Simply Iconic	3,2/3,7/4,2	Purple 3.0	R/NR	0021
IMPLANT DIRECT	Simply Iconic	4,7/5,2/5,7	Gold 3.4	R/NR	0022
IMPLANT GENESIS	Aktiv System	3,5/3,75/4,2/5	Standard	R/NR	0040
IMPLANTSWISS	Bone Level	3,3	3,3	R/NR	0004
IMPLANTSWISS	Bone Level	3,7	3,7	R/NR	0030
IMPLANTSWISS	Bone Level	4,3	4,3	R/NR	0030
IMPLANTSWISS	Bone Level	4,8	4,8	R/NR	0030
IMPLANTSWISS	Bone Level	5,5	5,5	R/NR	0030
IMPLANTSWISS	Multi Unit Abutment	Universal	4,8	R	0025

COMPATIBILITIES AVAILABLE

BRAND	MODEL	IMPLANT Ø	PLATFORM	ROTATION	COMPATIBILITY CODE
INTRA-LOCK	Unihex	4	Regular	R/NR	0024
INTRA-LOCK	Unihex	4,75	Wide	R/NR	0024
INTRA-LOCK	IntraHex	3,75/4	3,5	R/NR	0040
INTRA-LOCK	IntraHex	4,75	4,5	R/NR	0041
JDENTALCARE	JDEvolution/JDEvolution Plus	3,7	3,7	R/NR	0040
JDENTALCARE	JDEvolution/JDEvolution Plus	4,3/5	4	R/NR	0040
JDENTALCARE	JDEvolution/JDEvolution Plus	6	5	R/NR	0040
JDENTALCARE	JD Pterygo	4	4	R/NR	0040
JDENTALCARE	JD ICON	3,9	3,9	R/NR	0022
JDENTALCARE	JD ICON	4,3	4	R/NR	0022
JDENTALCARE	JD ICON	5	4,7	R/NR	0022
JDENTALCARE	JD ICON Plus	3,7	3,7	R/NR	0015
JDENTALCARE	JD ICON Plus	4,3	4	R/NR	0015
JDENTALCARE	JD ICON Plus	5	4,8	R/NR	0015
JDENTALCARE	JD ICON Plus T	3,5	3,5	R/NR	0015
JDENTALCARE	JD ICON Plus T	4	3,5	R/NR	0015
JDENTALCARE	JD ICON Plus T	4,5	3,5	R/NR	0015
JDENTALCARE	Conical Abutment		Universal	R	0025
KEystone	Restore	3,75/4	RD 4,1	R/NR	0024
KEystone	Internal TiLobe PrimaConnex	3,3/3,5	3,5	R/NR	0044
KEystone	Internal TiLobe PrimaConnex	4/4,1	4,1	R/NR	0045
KEystone	Internal TiLobe PrimaConnex	5	5	R/NR	0046
KEystone	Internal TiLobe Prima Plus	3,5	3,5	R/NR	0044
KEystone	Internal TiLobe Prima Plus	4,1	4,1	R/NR	0045

COMPATIBILITIES AVAILABLE

BRAND	MODEL	IMPLANT Ø	PLATFORM	ROTATION	COMPATIBILITY CODE
KEYSTONE	Internal TiLobe Prima Plus	5/6	5	R/NR	0046
KLOCKNER	Essential Cone	3,5/4/4,5	4,5	R/NR	0054
KLOCKNER	KL	3,3	Narrow	R/NR	0023
KLOCKNER	KL	3,7/4,2	Regular	R/NR	0024
KLOCKNER	KL	4,7	Wide	R/NR	0061
KLOCKNER	Vega	3,5	NV	R/NR	0082
KLOCKNER	Vega	4/4,5	RV	R/NR	0083
KLOCKNER	Vega+	3,6	NV	R/NR	0082
KLOCKNER	Vega+	4,1/4,6	RV	R/NR	0083
KLOCKNER	Multi Unit Permanent	4,2	Universal	R	0173
LASAK	Bioniq	2,9	QN (Amarillo)	R/NR	0166
LASAK	Bioniq	3,5	QR (Azul)	R/NR	0167
LASAK	Bioniq	4	QR (Azul)	R/NR	0167
LASAK	Bioniq	5	QR (Azul)	R/NR	0167
LEADER	Tixos Internal Hex	3,3	3,5	R/NR	0040
LEADER	Tixos Internal Hex	3,75	4	R/NR	0040
LEADER	Tixos External Hex	3,3/3,75	4,1	R/NR	0024
LEADER	Tixos External Hex	5	5	R/NR	0058
MEDENTIKA	Multi Unit		Universal	R	0025
MEDENTIS	Premium/Active Master	3,3	3,3 (Pink)	R/NR	0249
MEDENTIS	Premium/Active Master	3,75	3,75 (Red)	R/NR	0125
MEDENTIS	Premium/Active Master	4,1	4,1 (Green)	R/NR	0125
MEDENTIS	Premium/Active Master	4,8	4,8 (Blue)	R/NR	0125
MEGAGEN	AnyRidge	3,5	Small	R/NR	0015

COMPATIBILITIES AVAILABLE

BRAND	MODEL	IMPLANT Ø	PLATFORM	ROTATION	COMPATIBILITY CODE
MEGAGEN	AnyRidge	4/4,5	Regular	R/NR	0015
MEGAGEN	AnyRidge	5/5,5	Wide	R/NR	0015
MEGAGEN	AnyOne Internal	3,5/4/4,5/5/6/7	General	R/NR	0030
MEGAGEN	AnyOne External	3,5	Small 3,5	R/NR	0023
MEGAGEN	AnyOne External	4	Regular 4,1	R/NR	0024
MEGAGEN	AnyOne External	4,5	Regular 4,5	R/NR	0024
MEGAGEN	AnyOne External	5	Wide 5	R/NR	0058
MEGAGEN	AnyOne External	6	SuperWide 5,5	R/NR	0058
MEGAGEN	Cone Abutment	Universal	4,8	R/NR	0074
MEGAGEN	Mini Narrow Ridge	3/3,4	Mini	R/NR	0014
MEGAGEN	ExFeel	3,5	Small	R/NR	0037
MEGAGEN	ExFeel	4,1	Regular	R/NR	0037
MEGAGEN	ExFeel	4,8/5	Wide	R/NR	0037
MEGAGEN	Cone Abutment	Universal	3,8	R	0128
MEGAGEN	Multi Unit N Type	Multi Unit N Type	Universal	R	0025
MICRODENT	Universal	2,8/3,25	3,5	R/NR	0003
MICRODENT	Universal	3,3/3,5/3,75/4	4,1	R/NR	0024
MICRODENT	Universal	4,2/5	5,1	R/NR	0058
MICRODENT	System	2,8/3,25	3,5	R/NR	0003
MICRODENT	Ektos	3,7/4,2	3,5	R/NR	0040
MIS	Lance	3,75/4,2	Standard	R/NR	0024
MIS	Lance	5	Wide	R/NR	0058
MIS	Seven	3,3	Narrow	R/NR	0019
MIS	Seven	3,75/4,2	Standard	R/NR	0040

COMPATIBILITIES AVAILABLE

BRAND	MODEL	IMPLANT Ø	PLATFORM	ROTATION	COMPATIBILITY CODE
MIS	Seven	5/6	Wide	R/NR	0041
MIS	M4	3,3	Narrow	R/NR	0019
MIS	M4	3,75/4,2	Standard	R/NR	0040
MIS	M4	5/6	Wide	R/NR	0041
MIS	C1	3,3	Narrow	R/NR	0016
MIS	C1	3,75/4,2	Standard	R/NR	0017
MIS	C1	5	Wide	R/NR	0018
MIS	V3	3,9/4,3/5	Standard	R/NR	0017
MIS	Multi-Unit		General	R	0020
MOZO-GRAU (TICARE)	MG Osseous	3,3	3,4 Mini	R/NR	0003
MOZO-GRAU (TICARE)	MG Osseous	3,4/3,75/4,25	4,1 Standard	R/NR	0024
MOZO-GRAU (TICARE)	MG Osseous	5	5 Maxi	R/NR	0061
MOZO-GRAU (TICARE)	MG Inhex	3,3	2,3 Mini	R/NR	0109
MOZO-GRAU (TICARE)	MG Inhex	3,75/4,25	2,8 Standard	R/NR	0004
MOZO-GRAU (TICARE)	MG Inhex	5	3,8 Maxi	R/NR	0005
MPI	Conexión Externa HE Privilege	3,3	3,5	R/NR	0009
MPI	Conexión Externa HE Privilege	3,3/4	4,1	R/NR	0024
MPI	Conexión Externa HE Privilege	5	5	R/NR	0058
MPI	Privilege CM	3,5/4	Regular	R/NR	0004
MPI	Privilege CM	5	Wide	R/NR	0005
MPI	Excellence CM	3,5/4	Regular	R/NR	0004
MPI	Excellence CM	5	Wide	R/NR	0005
NEOBIOTECH	EB External System	3,5	Narrow	R/NR	0023
NEOBIOTECH	IS Implant System	3,2	S-Narrow	R/NR	0029

COMPATIBILITIES AVAILABLE

BRAND	MODEL	IMPLANT Ø	PLATFORM	ROTATION	COMPATIBILITY CODE
NEOBIOTECH	IS Implant System	3,5	Narrow	R/NR	0030
NEOBIOTECH	IS Implant System	4	Regular	R/NR	0030
NEOBIOTECH	IS Implant System	4,5	Regular	R/NR	0030
NEOBIOTECH	IS Implant System	5	Wide	R/NR	0030
NEOBIOTECH	IS Implant System		4,8	R	0025
NEODENT	Helix GM/Drive GM/Titamax GM	3,5/3,75/4/4,3/5/6	Regular	R/NR	0186
NEODENT	Smart HE	3,75/4	4,1	R/NR	0024
NEODENT	Mini Pilar CM / Mini Pilar Angulado CM	Mini Pilar CM / Mini Pilar Angulado CM	Universal	R	0025
NEOSS	ProActive Straight/Tapered/Edge	3,5 Green	Standard	R/NR	0047
NEOSS	ProActive Straight/Tapered/Edge	4 Yellow	Standard	R/NR	0047
NEOSS	ProActive Straight/Tapered/Edge	4,5 Blue	Standard	R/NR	0048
NEOSS	ProActive Straight/Tapered/Edge	5 Peach	Standard	R/NR	0048
NEOSS	ProActive Straight/Tapered/Edge	5,5 Lilac	Standard	R/NR	0048
NEOSS	ProActive Wide	6	Standard	R/NR	0048
NEOSS	ProActive Sinus	6,5	Standard	R/NR	0048
NEOSS	Short Implant	3,5/4/4,5	Standard	R/NR	0047
NEOSS	Short Implant	5/5,5/6/6,5	Standard	R/NR	0048
NOBEL BIOCARE	Branemark	3,3	Narrow	R/NR	0023
NOBEL BIOCARE	Branemark	3,75/4	Regular	R/NR	0024
NOBEL BIOCARE	Branemark	5/6	Wide	R/NR	0061
NOBEL BIOCARE	Replace	3,5	Narrow	R/NR	0026
NOBEL BIOCARE	Replace	4,3	Regular	R/NR	0027
NOBEL BIOCARE	Replace	5	Wide	R/NR	0028
NOBEL BIOCARE	Replace	6	Platform 6	R/NR	0129

COMPATIBILITIES AVAILABLE

BRAND	MODEL	IMPLANT Ø	PLATFORM	ROTATION	COMPATIBILITY CODE
NOBEL BIOCARE	Active/Replace Conical Connection	3	Mini 3.0	R/NR	0159
NOBEL BIOCARE	Active/Replace Conical Connection	3,5	Narrow	R/NR	0021
NOBEL BIOCARE	Active/Replace Conical Connection	4,3/5	Regular	R/NR	0022
NOBEL BIOCARE	Active/Replace Conical Connection	5,5	Wide	R/NR	0124
NOBEL BIOCARE	NobelSpeedy	3,3	Narrow	R/NR	0023
NOBEL BIOCARE	NobelSpeedy	4/5	Regular	R/NR	0024
NOBEL BIOCARE	NobelSpeedy	5/6	Wide	R/NR	0061
NOBEL BIOCARE	NobelParallel	3,75	Narrow	R/NR	0021
NOBEL BIOCARE	NobelParallel	4,3/5	Regular	R/NR	0022
NOBEL BIOCARE	NobelParallel	5,5	Wide	R/NR	0124
NOBEL BIOCARE	Multi-Unit	Regular	Regular	R	0025
NORIS MEDICAL	Tuff	3,3/3,75/4,2/5/6	3,75	R/NR	0040
NORIS MEDICAL	Tuff TT	3,3/3,75/4,2/5/6	3,75	R/NR	0040
NORIS MEDICAL	Onix	3,3/3,75/4,2/5/6	3,75	R/NR	0040
NORIS MEDICAL	Cortical	4,0/5/6	3,75	R/NR	0040
NORIS MEDICAL	PteryCore	4,2	3,75	R/NR	0040
NORIS MEDICAL	PteryFit	4,2	3,75	R/NR	0040
NORMON	Normoimplant HE	3,25/3,75/4,25/4,75	4,1	R/NR	0024
NORMON	Normoimplant HI	3,75/4,25/4,75	3,5	R/NR	0040
NOVA IMPLANTS	PSI/PCI	3,3/3,75/4,2/5/6	3,75	R/NR	0040
OSSTEM IMPLANT	TS	3,5	Mini 3,5	R/NR	0029
OSSTEM IMPLANT	TS	4/4,5/5/6/7	Regular	R/NR	0030
OSSTEM IMPLANT	US	3,3/3,5	Mini 3,5	R/NR	0023
OSSTEM IMPLANT	US	3,75/4/4,5	Regular 4,1	R/NR	0024

COMPATIBILITIES AVAILABLE

BRAND	MODEL	IMPLANT Ø	PLATFORM	ROTATION	COMPATIBILITY CODE
OSSTEM IMPLANT	US	5/5,5	Wide 5,1	R/NR	0061
OSSTEM IMPLANT	US	5/5,5	Wide PS 5	R/NR	0058
OSTEOPLUS	She	3,45	3,45	R/NR	0009
OSTEOPLUS	She	3,75 / 4	4	R/NR	0024
OSTEOPLUS	Shi	3,3 / 3,75 / 4,2	3,5	R/NR	0040
OXY	K1 Line	3,5/4/4,5/5	Regular	R/NR	0015
OXY	K1 Line	5,5/6/6,5	Wide	R/NR	0015
OXY	PSK Line	3,5/4/4,5/5	Regular	R/NR	0015
OXY	MD Line KONE	3,75/4.25/5	Regular	R/NR	0015
OXY	MD Line Ext	3,75/4,25	Standard	R/NR	0024
PALTOP	Advanced classic	3,25	Narrow (blue)	R/NR	0229
PALTOP	Advanced classic	6	Wide (purple)	R/NR	0041
PALTOP	Advanced +	3,25	Narrow (blue)	R/NR	0229
PALTOP	Advanced +	6	Wide (purple)	R/NR	0041
PALTOP	Dynamic	3,25	Narrow (blue)	R/NR	0229
PALTOP	Dynamic	6	Wide (purple)	R/NR	0041
PALTOP	Conical Active	3,25/3,75/4,2/5	Standard	R/NR	0029
PALTOP	Advanced classic	3,75/4,2/5	Standard	ZIO	0042
PALTOP	Advanced +	3,75/4,2/5	Standard	ZIO	0042
PALTOP	Dynamic	3,75/4,2/5	Standard	ZIO	0042
PALTOP	DIVA/ACTIVE	3,75/4,2/5	Standard	ZIO	0042
PALTOP	Advanced classic	3,75/4,2/5	Standard	R	0040
PALTOP	Advanced +	3,75/4,2/5	Standard	R	0040
PALTOP	Dynamic	3,75/4,2/5	Standard	R	0040

COMPATIBILITIES AVAILABLE

BRAND	MODEL	IMPLANT Ø	PLATFORM	ROTATION	COMPATIBILITY CODE
PALTOP	DIVA/ACTIVE	3,75/4,2/5	Standard	R	0040
PALTOP	Universal Multi-Unit	Multi-Unit	Universal	R	0181
PHIBO	TSH/BNT Serie 3	3,6	4	R/NR	0024
PHIBO	TSH/BNT Serie 4	4,2	4	R/NR	0024
PROCLINIC	Cilindrico Externo/Cónico Externo	3,75/4,25//3,5/4	4,1 Estandar	R/NR	0024
PROCLINIC	Cilindrico Externo/Cónico Externo	5	5 Maxi	R/NR	0058
PROCLINIC	Cilindrico Interno/Cónico Interno	3,3/3,75/4,25/5//3,5/4/5	3,5	R/NR	0040
PROCLINIC	SP Octa	3,3/4,1/4,8	4,8	R/NR	0074
PROCLINIC	SP Octa	3,3/4,1/4,8	4,8	R/NR	0037
PROCLINIC	SP Octa	4,8	6,5	R/NR	0096
PROCLINIC	Aqua CM	3,5/4/5	2,82	R/NR	0004
RADHEX	PHE	3,5	3,5	R/NR	0023
RADHEX	PHE	4/4,5/5	4,1	R/NR	0024
RADHEX	PHI	3,75	3,5	R/NR	0040
RADHEX	PHI	4,5/5	4,5	R/NR	0041
REFLECT	Rapid	3,0	3,0	R/NR	0159
REFLECT	Rapid	3,5	NP	R/NR	0021
REFLECT	Rapid	4,3/5/5,5	RP	R/NR	0022
REFLECT	Recover	3,5	NP	R/NR	0021
REFLECT	Recover	4,3/5	RP	R/NR	0022
REFLECT	Aspire	3,5/4	Aqua(Estrecha)	R/NR	0004
REFLECT	Aspire	5	Lilac (Ancha)	R/NR	0005
REFLECT	Tapered Screw	3,5	3,5	R/NR	0040
REFLECT	Tapered Screw	4,1/4,7	4,5	R/NR	0041

COMPATIBILITIES AVAILABLE

BRAND	MODEL	IMPLANT Ø	PLATFORM	ROTATION	COMPATIBILITY CODE
SEWON MEDIX	IH2 SLA SYSTEM	3,5	Mini	R/NR	0029
SEWON MEDIX	IH2 SLA SYSTEM	3,5/4/4,5/5	Regular	R/NR	0030
SEWON MEDIX	IH2 RBM SYSTEM	3,5	Mini	R/NR	0029
SEWON MEDIX	IH2 RBM SYSTEM	3,5/4/4,5/5	Regular	R/NR	0030
SEWON MEDIX	IH SYSTEM	3,5/4/4,5/5	Universal	R	0025
SIC INVENT	HEXAGONAL SYSTEM SICace	3,4/4	3,3	R/NR	0170
SIC INVENT	HEXAGONAL SYSTEM SICace	4,5/5	4,2	R/NR	0171
SIC INVENT	HEXAGONAL SYSTEM SICMax	3,4/4,2	3,3	R/NR	0170
SIC INVENT	HEXAGONAL SYSTEM SICMax	4,7/5,2	4,2	R/NR	0171
SIC INVENT	HEXAGONAL SYSTEM SICtapered	3,4/4,2	3,3	R/NR	0170
SIC INVENT	HEXAGONAL SYSTEM SICtapered	4,7/5,2	4,2	R/NR	0171
SIGNO VINCES	Duo	4,6	4,1	R/NR	0024
SIGNO VINCES	Inttegra	3,75/4	4,1	R/NR	0024
SIGNO VINCES	Compact	4,5	CM3,8	R/NR	0004
SIGNO VINCES	Duocon	3,8	CM3,8	R/NR	0004
SIGNO VINCES	Duocon	4,6/5,5	CM4,6	R/NR	0005
SIGNO VINCES	Infra	3,3/3,8/4,6	CM	R/NR	0004
SIN IMPLANTS	HI SW	3,8	3,8	R/NR	0039
SIN IMPLANTS	Tryon	3,25/3,75/4	4,1	R/NR	0024
SIN IMPLANTS	Tryon CO	4	4,1	R/NR	0024
SIN IMPLANTS	Revolution	3,25/3,75/4	4,1	R/NR	0024
SIN IMPLANTS	Stylus	4	4,1	R/NR	0024
SOUTHERN IMPLANTS	Tri-Nex	3,5	3,5	R/NR	0026
SOUTHERN IMPLANTS	Tri-Nex	4,3	4,3	R/NR	0027

COMPATIBILITIES AVAILABLE

BRAND	MODEL	IMPLANT Ø	PLATFORM	ROTATION	COMPATIBILITY CODE
SOUTHERN IMPLANTS	Tri-Nex	5	5	R/NR	0028
SOUTHERN IMPLANTS	Tri-Nex	6	6	R/NR	0129
SOUTHERN IMPLANTS	IT Connection	3,3/4/4,1/4,9/5	4,8	R/NR	0037
SOUTHERN IMPLANTS	IT Connection	4,9/5/6	6,5	R/NR	0096
SOUTHERN IMPLANTS	External Hex	3,25	3,4	R/NR	0003
SOUTHERN IMPLANTS	External Hex	3,75/4	4,1	R/NR	0024
SOUTHERN IMPLANTS	External Hex	4,7/5	5	R/NR	0058
SOUTHERN IMPLANTS	External Hex	5,7/6	6	R/NR	0058
SOUTHERN IMPLANTS	Deep Conical	3	2,45	R/NR	0109
SOUTHERN IMPLANTS	Deep Conical	3,5/4	2,95/3,1	R/NR	0004
SOUTHERN IMPLANTS	Deep Conical	5	4,1	R/NR	0005
SOUTHERN IMPLANTS	Internal Hex	3,75/4,2/5	Universal	R/NR	0040
SOUTHERN IMPLANTS	Provata	4/5/6	Standard	R/NR	0040
SOUTHERN IMPLANTS	Compact Conical	4,8	4,8	R	0025
STERI-OSS	Hex-Loc	3,25	3,3	R/NR	0023
STERNGOLD	STERN EX	3,75/4/5	4,1	R/NR	0024
STRAUMANN	Tissue Level	3,3	3,5	R/NR	0160
STRAUMANN	Tissue Level	3,3/4,1/4,8	Regular 4,8	R/NR	0037
STRAUMANN	Tissue Level	4,8	Wide 6,5	R/NR	0096
STRAUMANN	Synocta		Regular 4,8	R/NR	0074
STRAUMANN	Synocta		Wide 6,5	R/NR	0137
STRAUMANN	Bone Level Tapered SC	2,9	SC- 2,9	R/NR	0135
STRAUMANN	Bone Level	3,3	NC- 3,3	R/NR	0033
STRAUMANN	Bone Level	4,1	RC-4,1	R/NR	0035

COMPATIBILITIES AVAILABLE

BRAND	MODEL	IMPLANT Ø	PLATFORM	ROTATION	COMPATIBILITY CODE
STRAUMANN	Bone Level	4,8	RC-4,8	R/NR	0035
STRAUMANN	BLX	3,5/3,75/4/4,5	RB (Regular Base)	R/NR	0207
STRAUMANN	BLX	5/5,5/6,5	WB (Wide Base)	R/NR	0208
STRAUMANN	TLX / TLX S	3,75/4,5	NT	R/NR	0260
STRAUMANN	TLX / TLX S	3,75/4,5	RT	R/NR	0261
STRAUMANN	TLX / TLX S	5,5/6,5	WT	R/NR	0262
STRAUMANN	Screw-Retained	NC/RC 04,6	Universal	R	0101
SYBRON IMPLANT SOLUTIONS	Endopore (Innova)	4,1	4,1	R/NR	0024
TBR	Hex-Conic	5	Wide	R/NR	0058
TBR	Connect / Infinity	3,5	3,5	R/NR	0266
TBR	Connect / Infinity	4	4	R/NR	0267
TBR	Connect / Infinity	5	5	R/NR	0268
TITANIUM-FIX	b-fix	3,5/4	Regular	R/NR	0004
TITANIUM-FIX	b-fix	4,5/5	Larga	R/NR	0005
TREE-OSS	Simple	3,3/3,75/5	3,75 Amarillo	R/NR	0040
TREE-OSS	Rapid/Anatomic	3,3	3,5 Rosa	R/NR	0023
TREE-OSS	Rapid/Anatomic	3,75/4	4,1 Amarillo	R/NR	0024
TREE-OSS	Rapid/Anatomic	5	5,1 Azul	R/NR	0061
TREE-OSS	Anatomic/HS	3,5	3,5 Rosa	R/NR	0026
TREE-OSS	Anatomic/HS	4,3	4,3 Amarillo	R/NR	0027
TREE-OSS	Anatomic/HS	5	5 Azul	R/NR	0028
TREE-OSS	Multi Unit		Universal	R	0025
TRI DENTAL IMPLANTS	TRI-Vent	3,75/4,1/4,7	3,5	ZIO	0042
TRI DENTAL IMPLANTS	TRI-Vent	3,75/4,1/4,7	3,5	R	0040

COMPATIBILITIES AVAILABLE

BRAND	MODEL	IMPLANT Ø	PLATFORM	ROTATION	COMPATIBILITY CODE
TRINON	QZ	3,5/3,75/4,5	4	R/NR	0024
TRINON	QK	4	4,8	R/NR	0074
TRINON	QK	4	4,8	R/NR	0037
UFIT	Gt2	3,5	Mini	R/NR	0004
UFIT	Gt2	4/4,5	Regular	R/NR	0005
UFIT	Gt2	5	Wide	R/NR	0005
UFIT	Gt2	5,5/6/6,5/7	Ultra-wide	R/NR	0005
UFIT	Nt2	3,5	Mini	R/NR	0004
UFIT	Nt2	4/4,5	Regular	R/NR	0005
UFIT	Nt2	5	Wide	R/NR	0005
UFIT	Nt2	5,5/6/6,5/7	Ultra-wide	R/NR	0005
VULKAN IMPLANTS	IN-Hex	3,3/3,75/4,2/5	3,75	R/NR	0040
WIN	WIN	3,30/3,75/4,25/5	3,75	R/NR	0040
WIN	WIN	Universal	Universal	R	0025
XIVE	Xive	3	3	R/NR	0084
XIVE	Xive	3,4	3,4	R/NR	0038
XIVE	Xive	3,8	3,8	R/NR	0039
XIVE	Xive	4,5	4,5	R/NR	0085
XIVE	Xive	5,5	5,5	R/NR	0086
YES IMPLANT	S-SYSTEM	3,3/3,5	Narrow	R/NR	0030
YES IMPLANT	S-SYSTEM	4/4,5	Regular	R/NR	0030
YES IMPLANT	S-SYSTEM	5/5,5	Wide	R/NR	0030
ZIACOM	OEX	3,75/4,25	RP 4,1	R/NR	0024
ZIMMER	Screw-Vent	3,7/4,1	3,5	R/NR	0040

COMPATIBILITIES AVAILABLE

BRAND	MODEL	IMPLANT Ø	PLATFORM	ROTATION	COMPATIBILITY CODE
ZIMMER	Screw-Vent	6	5,7	R/NR	0080
ZIMMER	TSX Implant	3,1	2,9	R/NR	0178
ZIMMER	TSX Implant	3,7/4,1/4,7	3,5	R/NR	0040
ZIMMER	TSX Implant	5,4/6	4,5	R/NR	0041
ZIMMER	Swiss-Plus	3,7/4,1/4,8	4,8	R/NR	0074
ZIMMER	Swiss-Plus	3,7/4,1/4,8	4,8	R/NR	0037
ZIMMER	Eztetic	3,1	2,9	R/NR	0178
ZIMMER	Screw-Vent	3,7/4,1	3,5	ZIO	0042
ZIMMER	Screw-Vent	4,7	4,5	ZIO	0043
ZIMMER	TSX Implant	3,7/4,1/4,7	3,5	ZIO	0042
ZIMMER	TSX Implant	5,4/6	4,5	ZIO	0043
ZIMMER	Tapered Abutment	Universal	Universal	R	0205

COMPATIBLE with 0001

STANDARD DYNAMIC TIBASE®															
	GINGIVAL HEIGHT	α_s	α_c	GINGIVAL HEIGHT	α_s	α_c	GINGIVAL HEIGHT	α_s	α_c	GINGIVAL HEIGHT	α_s	α_c	GINGIVAL HEIGHT	α_s	α_c
	0,3 mm			1,2 mm			2 mm			3 mm			mm		
R	31.322.001.01-2	43°	25°	31.322.001.02-2	25°	-	31.322.001.03-2	25°	-	31.322.001.04-2	20°	-	-	-	-
NR	31.312.001.01-2			31.312.001.02-2			31.312.001.03-2			31.312.001.04-2			-	-	-

DYNAMIC 3TIBASE®				
	GINGIVAL HEIGHT	α_s	α_s	α_s
	0,3 mm	CH=5mm	CH= 7mm	CH= 9mm
R	31.322.001.21-2	25°	20°	10°
NR	31.312.001.21-2			

DYNAMIC μ SCANBODY (LAB/CLIN)				DIGITAL ANALOG
SCANBODY	HEIGHT mm	ADAPTOR	SCREWDRIVER ADAPTOR	DIGITAL ANALOG
52.410.103.01-2	10	50.312.001.01-2	43.621.410.01-2	34.612.001.01-2
		50.312.001.04-2 (IG=3mm)	43.624.410.01-2	
52.412.103.01-2	12			

DYNAMIC MILLING TOOL		
DYNAMIC MILLING TOOL	SHANK	α_{di}
33.390.754.01-2	3	25°
33.490.754.01-2	4	
33.690.754.01-2	6	

SCANALOG
23.412.001.01-2

DYNAMIC SCREWS			
DYNAMIC SCREW	HIGH DYNAMIC SCREW	DYNAMIC SCREWDRIVER	SCREWDRIVER LENGTH (mm)
41.316.084.01-2	-	43.618.201.01-2	18
		43.624.201.01-2	24
		43.632.201.01-2	32

STRAIGHT SCREWS	
STRAIGHT SCREW	SCREWDRIVER Hex. 1.20
40.316.003.01-2	43.601.103.02-2

ANALOG	LAB SCANBODY
22.612.001.01-2	30.412.001.01-2

MULTI-UNIT				
	GINGIVAL HEIGHT	GINGIVAL HEIGHT	GINGIVAL HEIGHT	GINGIVAL HEIGHT
	1 mm	2 mm	3 mm	4 mm
R	42.302.001.01-2	42.302.001.02-2	42.302.001.03-2	42.302.001.04-2

LIBRARY OPTIONS
GH = Gingival Height
CH = Cement Height
IG = Adaptor 3mm
 α_s = Standard maximum angulation
 α_c = Captive maximum angulation
 α_{di} = Direct to implant maximum angulation
 α_{dp} = Dynamic Premilled maximum angulation
R = Rotational / Non-Engaging
NR = Non Rotational / Engaging

COMPATIBLE with 0002

STANDARD DYNAMIC TIBASE®															
	GINGIVAL HEIGHT	α_s	α_c	GINGIVAL HEIGHT	α_s	α_c	GINGIVAL HEIGHT	α_s	α_c	GINGIVAL HEIGHT	α_s	α_c	GINGIVAL HEIGHT	α_s	α_c
	0,3 mm			1,2 mm			mm			mm			mm		
R	31.323.002.01-2	45°	20°	31.323.002.02-2	25°	-	-	-	-	-	-	-	-	-	-
NR	31.313.002.01-2			31.313.002.02-2			-	-	-	-	-				

DYNAMIC 3TIBASE®				
	GINGIVAL HEIGHT	α_s	α_s	α_s
	0,3 mm	CH=5mm	CH= 7mm	CH= 9mm
R	31.323.002.21-2	25°	20°	10°
NR	31.313.002.21-2			

DYNAMIC μ SCANBODY (LAB/CLIN)				DIGITAL ANALOG
SCANBODY	HEIGHT mm	ADAPTOR	SCREWDRIVER ADAPTOR	DIGITAL ANALOG
52.408.101.01-2	8	50.313.002.01-2	43.621.410.01-2	34.613.002.01-2
52.410.101.01-2	10		43.624.410.01-2	
52.412.101.01-2	12			

DYNAMIC MILLING TOOL		
DYNAMIC MILLING TOOL	SHANK	α_{di}
33.390.805.01-2	3	30°
33.490.805.01-2	4	
33.690.805.01-2	6	

SCANALOG
23.413.002.01-2

DYNAMIC SCREWS			
DYNAMIC SCREW	HIGH DYNAMIC SCREW	DYNAMIC SCREWDRIVER	SCREWDRIVER LENGTH (mm)
41.316.084.01-2	-	43.618.201.01-2	18
		43.624.201.01-2	24
		43.632.201.01-2	32

STRAIGHT SCREWS	
STRAIGHT SCREW	SCREWDRIVER Hex. 1.20
40.316.003.01-2	43.601.103.02-2

ANALOG	LAB SCANBODY
22.613.002.01-2	30.413.002.01-2

MULTI-UNIT				
	GINGIVAL HEIGHT	GINGIVAL HEIGHT	GINGIVAL HEIGHT	GINGIVAL HEIGHT
	1 mm	2 mm	3 mm	4 mm
R	42.303.002.01-2	42.303.002.02-2	42.303.002.03-2	42.303.002.04-2

LIBRARY OPTIONS
GH = Gingival Height
CH = Cement Height
IG = Adaptor 3mm
 α_s = Standard maximum angulation
 α_c = Captive maximum angulation
 α_{di} = Direct to implant maximum angulation
 α_{dp} = Dynamic Premilled maximum angulation
R = Rotational / Non-Engaging
NR = Non Rotational / Engaging

COMPATIBLE with 0003

STANDARD DYNAMIC TIBASE®															
	GINGIVAL HEIGHT	α_s	α_c	GINGIVAL HEIGHT	α_s	α_c	GINGIVAL HEIGHT	α_s	α_c	GINGIVAL HEIGHT	α_s	α_c	GINGIVAL HEIGHT	α_s	α_c
	0,3 mm			0,5 mm			mm			mm			mm		
R	31.322.003.01-2	45°	30°	31.322.003.02-2	25°	-	-	-	-	-	-	-	-	-	-
NR	31.312.003.01-2			31.312.003.02-2			-	-	-	-	-	-	-	-	-

DYNAMIC 3TIBASE®				
	GINGIVAL HEIGHT	α_s	α_s	α_s
	1 mm	CH=5mm	CH= 7mm	CH= 9mm
R	31.322.003.23-2	30°	25°	15°
NR	31.312.003.23-2			

DYNAMIC μ SCANBODY (LAB/CLIN)				DIGITAL ANALOG
SCANBODY	HEIGHT mm	ADAPTOR	SCREWDRIVER ADAPTOR	DIGITAL ANALOG
52.410.104.01-2	10	50.312.003.01-2	43.621.410.01-2	34.612.003.01-2
			43.624.410.01-2	
52.412.104.01-2	12			

DYNAMIC MILLING TOOL			
DYNAMIC MILLING TOOL	SHANK	α_{di}	
33.390.716.01-2	3	25°	
33.490.716.01-2	4		
33.690.716.01-2	6		

DYNAMIC SCREWS			
DYNAMIC SCREW	HIGH DYNAMIC SCREW	DYNAMIC SCREWDRIVER	SCREWDRIVER LENGTH (mm)
41.320.065.01-2	-	43.618.201.01-2	18
		43.624.201.01-2	24
		43.632.201.01-2	32

STRAIGHT SCREWS	
STRAIGHT SCREW	SCREWDRIVER Hex. 1.20
40.320.003.02-2	43.601.103.02-2

ANALOG	LAB SCANBODY
22.612.003.01-2	30.412.001.01-2

LIBRARY OPTIONS

GH = Gingival Height
CH = Cement Height
IG = Adaptor 3mm

α_s = Standard maximum angulation
 α_c = Captive maximum angulation
 α_{di} = Direct to implant maximum angulation
 α_{dp} = Dynamic Premilled maximum angulation

R = Rotational / Non-Engaging
NR = Non Rotational / Engaging

COMPATIBLE with 0004

STANDARD DYNAMIC TIBASE®															
	GINGIVAL HEIGHT	α_s	α_c	GINGIVAL HEIGHT	α_s	α_c	GINGIVAL HEIGHT	α_s	α_c	GINGIVAL HEIGHT	α_s	α_c	GINGIVAL HEIGHT	α_s	α_c
	1 mm			2 mm			3 mm			4 mm			mm		
R	31.323.004.01-2	45°	29°	31.323.004.02-2	30°	20°	31.323.004.03-2	25	-	31.323.004.04-2	20	-	-	-	-
NR	31.313.004.01-2			31.313.004.02-2			31.313.004.03-2			31.313.004.04-2			-	-	-

DYNAMIC 3TIBASE®				
	GINGIVAL HEIGHT	α_s	α_s	α_s
	1 mm	CH=5mm	CH= 7mm	CH= 9mm
R	31.323.004.21-2	25°	20°	10°
NR	31.313.004.21-2			

DYNAMIC μ SCANBODY (LAB/CLIN)				DIGITAL ANALOG
SCANBODY	HEIGHT mm	ADAPTOR	SCREWDRIVER ADAPTOR	DIGITAL ANALOG
52.410.103.01-2	10	50.313.004.01-2	43.621.410.01-2	34.613.004.01-2
		50.313.004.03-2 (IG=3mm)	43.624.410.01-2	34.613.004.02-2
52.412.103.01-2	12			

DYNAMIC MILLING TOOL			α_{di}
DYNAMIC MILLING TOOL	SHANK		
33.390.754.01-2	3	25°	
33.490.754.01-2	4		
33.690.754.01-2	6		

SCANALOG
23.413.004.02-2

DYNAMIC SCREWS			
DYNAMIC SCREW	HIGH DYNAMIC SCREW	DYNAMIC SCREWDRIVER	SCREWDRIVER LENGTH (mm)
41.316.076.01-2	-	43.618.201.01-2	18
		43.624.201.01-2	24
		43.632.201.01-2	32

STRAIGHT SCREWS	
STRAIGHT SCREW	SCREWDRIVER Hex. 1.27
40.316.005.02-2	43.601.105.01-2

ANALOG	LAB SCANBODY
22.613.004.01-2	30.413.002.01-2

MULTI-UNIT				
	GINGIVAL HEIGHT	GINGIVAL HEIGHT	GINGIVAL HEIGHT	GINGIVAL HEIGHT
	1 mm	2 mm	3 mm	4 mm
R	42.303.004.01-2	42.303.004.02-2	42.303.004.03-2	42.303.004.04-2

LIBRARY OPTIONS

GH = Gingival Height
CH = Cement Height
IG = Adaptor 3mm

α_s = Standard maximum angulation
 α_c = Captive maximum angulation
 α_{di} = Direct to implant maximum angulation
 α_{dp} = Dynamic Premilled maximum angulation

R = Rotational / Non-Engaging
NR = Non Rotational / Engaging

COMPATIBLE with 0005

STANDARD DYNAMIC TIBASE®															
	GINGIVAL HEIGHT	α_s	α_c	GINGIVAL HEIGHT	α_s	α_c	GINGIVAL HEIGHT	α_s	α_c	GINGIVAL HEIGHT	α_s	α_c	GINGIVAL HEIGHT	α_s	α_c
	1 mm			2 mm			3 mm			4 mm			mm		
R	31.324.005.01-2	38°	23°	31.324.005.02-2	25°	15°	31.324.005.03-2	20	-	31.324.005.04-2	15	-	-	-	-
NR	31.314.005.01-2			31.314.005.02-2			31.314.005.03-2			31.314.005.04-2			-	-	-

DYNAMIC 3TIBASE®				
	GINGIVAL HEIGHT	α_s	α_s	α_s
	1 mm	CH=5mm	CH= 7mm	CH= 9mm
R	31.324.005.21-2	25°	20°	10°
NR	31.314.005.21-2			

DYNAMIC μ SCANBODY (LAB/CLIN)				DIGITAL ANALOG
SCANBODY	HEIGHT mm	ADAPTOR	SCREWDRIVER ADAPTOR	DIGITAL ANALOG
52.410.102.01-2	10	50.314.005.01-2	43.621.410.01-2	34.614.005.01-2
		50.314.005.03-2 (IG=3mm)	43.624.410.01-2	
52.412.102.01-2	12			

DYNAMIC MILLING TOOL		
DYNAMIC MILLING TOOL	SHANK	α_{di}
33.390.958.01-2	3	30°
33.490.958.01-2	4	
33.690.958.01-2	6	

DYNAMIC SCREWS			
DYNAMIC SCREW	HIGH DYNAMIC SCREW	DYNAMIC SCREWDRIVER	SCREWDRIVER LENGTH (mm)
41.320.090.01-2	-	43.618.201.01-2	18
		43.624.201.01-2	24
		43.632.201.01-2	32

STRAIGHT SCREWS	
STRAIGHT SCREW	SCREWDRIVER Hex. 1.27
40.320.005.03-2	43.601.105.01-2

ANALOG	LAB SCANBODY
22.614.005.01-2	30.413.002.01-2

LIBRARY OPTIONS

GH = Gingival Height
CH = Cement Height
IG = Adaptor 3mm

α_s = Standard maximum angulation
 α_c = Captive maximum angulation
 α_{di} = Direct to implant maximum angulation
 α_{dp} = Dynamic Premilled maximum angulation

R = Rotational / Non-Engaging
NR = Non Rotational / Engaging

COMPATIBLE with 0006

STANDARD DYNAMIC TIBASE®															
	GINGIVAL HEIGHT	α_s	α_c	GINGIVAL HEIGHT	α_s	α_c	GINGIVAL HEIGHT	α_s	α_c	GINGIVAL HEIGHT	α_s	α_c	GINGIVAL HEIGHT	α_s	α_c
	1,2 mm			2 mm			3 mm			4 mm			mm		
R	31.322.006.01-2	40°	20°	31.322.006.02-2	25	-	31.322.006.03-2	20	-	31.322.006.04-2	15	-	-	-	-
NR	31.312.006.01-2			31.312.006.02-2			31.312.006.03-2			31.312.006.04-2			-	-	-

DYNAMIC 3TIBASE®				
	GINGIVAL HEIGHT	α_s	α_s	α_s
		CH=5mm	CH= 7mm	CH= 9mm
R	31.322.006.21-2	30°	20°	15°
NR	31.312.006.21-2			

DYNAMIC μ SCANBODY (LAB/CLIN)				DIGITAL ANALOG
SCANBODY	HEIGHT mm	ADAPTOR	SCREWDRIVER ADAPTOR	DIGITAL ANALOG
52.410.105.01-2	10	50.312.006.03-2 (IG=3mm)	43.621.410.01-2	34.612.006.01-2
			43.624.410.01-2	
52.412.105.01-2	12			

DYNAMIC MILLING TOOL		
DYNAMIC MILLING TOOL	SHANK	α_{di}
33.330.734.01-2	3	25°
33.430.734.01-2	4	
33.630.734.01-2	6	

SCANALOG
23.412.006.01-2

DYNAMIC SCREWS			
DYNAMIC SCREW	HIGH DYNAMIC SCREW	DYNAMIC SCREWDRIVER	SCREWDRIVER LENGTH (mm)
41.316.072.01-2	-	43.618.201.01-2	18
		43.624.201.01-2	24
		43.632.201.01-2	32

STRAIGHT SCREWS	
STRAIGHT SCREW	SCREWDRIVER Hex. 1.27
40.316.005.01-2	43.601.105.01-2

ANALOG	LAB SCANBODY
22.612.006.01-2	30.412.001.01-2

MULTI-UNIT				
	GINGIVAL HEIGHT	GINGIVAL HEIGHT	GINGIVAL HEIGHT	GINGIVAL HEIGHT
	1 mm	2 mm	3 mm	4 mm
R	42.302.006.01-2	42.302.006.02-2	42.302.006.03-2	42.302.006.04-2

LIBRARY OPTIONS

GH = Gingival Height
CH = Cement Height
IG = Adaptor 3mm

α_s = Standard maximum angulation
 α_c = Captive maximum angulation
 α_{di} = Direct to implant maximum angulation
 α_{dp} = Dynamic Premilled maximum angulation

R = Rotational / Non-Engaging
NR = Non Rotational / Engaging

STANDARD DYNAMIC TIBASE®															
	GINGIVAL HEIGHT	α_s	α_c	GINGIVAL HEIGHT	α_s	α_c	GINGIVAL HEIGHT	α_s	α_c	GINGIVAL HEIGHT	α_s	α_c	GINGIVAL HEIGHT	α_s	α_c
	1,5 mm			2 mm			mm			mm			mm		
R	31.323.007.01-2	38°	17°	31.323.007.02-2	25°	-	-	-	-	-	-	-	-	-	-
NR	31.313.007.01-2			31.313.007.02-2			-	-	-	-	-	-	-	-	-

DYNAMIC 3TIBASE®				
	GINGIVAL HEIGHT	α_s	α_s	α_s
	1,5 mm	CH=5mm	CH= 7mm	CH= 9mm
R	31.323.007.21-2	25°	20°	10°
NR	31.313.007.21-2			

DYNAMIC μ SCANBODY (LAB/CLIN)				DIGITAL ANALOG
SCANBODY	HEIGHT mm	ADAPTOR	SCREWDRIVER ADAPTOR	DIGITAL ANALOG
52.408.101.01-2	8	50.313.007.01-2 50.313.007.03-2 (IG=3mm)	43.621.410.01-2 43.624.410.01-2	34.613.007.01-2
52.410.101.01-2	10			
52.412.101.01-2	12			

DYNAMIC MILLING TOOL			α_{di}
DYNAMIC MILLING TOOL	SHANK		
33.350.775.01-2	3	23.413.007.01-2	
33.450.775.01-2	4		
33.650.775.01-2	6		

SCANALOG
23.413.007.01-2

DYNAMIC SCREWS			
DYNAMIC SCREW	HIGH DYNAMIC SCREW	DYNAMIC SCREWDRIVER	SCREWDRIVER LENGTH (mm)
41.318.074.01-2	-	43.618.201.01-2	18
		43.624.201.01-2	24
		43.632.201.01-2	32

STRAIGHT SCREWS	
STRAIGHT SCREW	SCREWDRIVER Hex. 1.27
40.318.005.02-2	43.601.105.01-2

ANALOG	LAB SCANBODY
22.613.007.01-2	30.413.002.01-2

MULTI-UNIT				
	GINGIVAL HEIGHT	GINGIVAL HEIGHT	GINGIVAL HEIGHT	GINGIVAL HEIGHT
	1 mm	2 mm	3 mm	4 mm
R	42.303.007.01-2	42.303.007.02-2	42.303.007.03-2	42.303.007.04-2

LIBRARY OPTIONS
GH = Gingival Height
CH = Cement Height
IG = Adaptor 3mm
 α_s = Standard maximum angulation
 α_c = Captive maximum angulation
 α_{di} = Direct to implant maximum angulation
 α_{dp} = Dynamic Premilled maximum angulation
R = Rotational / Non-Engaging
NR = Non Rotational / Engaging

STANDARD DYNAMIC TIBASE®															
	GINGIVAL HEIGHT	α_s	α_c	GINGIVAL HEIGHT	α_s	α_c	GINGIVAL HEIGHT	α_s	α_c	GINGIVAL HEIGHT	α_s	α_c	GINGIVAL HEIGHT	α_s	α_c
	0,5 mm			mm			mm			mm			mm		
R	31.323.008.01-2	45°	30°	-	-	-	-	-	-	-	-	-	-	-	-
NR	-			-	-	-	-	-	-	-	-	-	-	-	-

DYNAMIC 3TIBASE®				
	GINGIVAL HEIGHT	α_s	α_s	α_s
	0,5 mm	CH=5mm	CH= 7mm	CH= 9mm
R	31.323.008.21-2	25°	20°	10°
NR	-			

DYNAMIC μ SCANBODY (LAB/CLIN)				DIGITAL ANALOG
SCANBODY	HEIGHT mm	ADAPTOR	SCREWDRIVER ADAPTOR	DIGITAL ANALOG
52.408.113.01-2	8	50.313.008.01-2	43.621.410.01-2 43.624.410.01-2	34.613.008.01-2

DYNAMIC MILLING TOOL			α_{di}
DYNAMIC MILLING TOOL	SHANK		
33.370.716.01-2	3	23.413.008.01-2	
33.470.716.01-2	4		
33.670.716.01-2	6		

SCANALOG
23.413.008.01-2

DYNAMIC SCREWS			
DYNAMIC SCREW	HIGH DYNAMIC SCREW	DYNAMIC SCREWDRIVER	SCREWDRIVER LENGTH (mm)
41.318.045.01-2	-	43.618.201.01-2	18
		43.624.201.01-2	24
		43.632.201.01-2	32

STRAIGHT SCREWS	
STRAIGHT SCREW	SCREWDRIVER Hex. 1.27
40.318.005.01-2	43.601.105.01-2

ANALOG	LAB SCANBODY
-	30.412.001.01-2

LIBRARY OPTIONS
GH = Gingival Height
CH = Cement Height
IG = Adaptor 3mm
 α_s = Standard maximum angulation
 α_c = Captive maximum angulation
 α_{di} = Direct to implant maximum angulation
 α_{dp} = Dynamic Premilled maximum angulation
R = Rotational / Non-Engaging
NR = Non Rotational / Engaging

STANDARD DYNAMIC TIBASE®															
	GINGIVAL HEIGHT	α_s	α_c	GINGIVAL HEIGHT	α_s	α_c	GINGIVAL HEIGHT	α_s	α_c	GINGIVAL HEIGHT	α_s	α_c	GINGIVAL HEIGHT	α_s	α_c
	0,3 mm			0,5 mm			1 mm			mm			mm		
R	31.322.009.01-2	45°	25°	31.322.009.02-2	25°	25°	31.322.009.03-2	25°	-	-	-	-	-	-	-
NR	31.312.009.01-2			31.312.009.02-2			31.312.009.03-2			-			-		

DYNAMIC 3TIBASE®				
	GINGIVAL HEIGHT	α_s	α_s	α_s
		CH=5mm	CH= 7mm	CH= 9mm
R	-	-	-	-
NR	-	-	-	-

DYNAMIC μ SCANBODY (LAB/CLIN)				DIGITAL ANALOG
SCANBODY	HEIGHT mm	ADAPTOR	SCREWDRIVER ADAPTOR	DIGITAL ANALOG
52.410.114.01-2	10	50.312.009.01-2	43.621.410.01-2 43.624.410.01-2	34.612.009.01-2
52.412.114.01-2	12			

DYNAMIC MILLING TOOL			
DYNAMIC MILLING TOOL	SHANK	α_{di}	
33.390.716.01-2	3	25°	
33.490.716.01-2	4		
33.690.716.01-2	6		

DYNAMIC SCREWS			
DYNAMIC SCREW	HIGH DYNAMIC SCREW	DYNAMIC SCREWDRIVER	SCREWDRIVER LENGTH (mm)
41.320.051.01-2	-	43.618.201.01-2	18
		43.624.201.01-2	24
		43.632.201.01-2	32

STRAIGHT SCREWS	
STRAIGHT SCREW	SCREWDRIVER Hex. 1.20
40.320.003.01-2	43.601.103.02-2

ANALOG	LAB SCANBODY
-	30.412.001.01-2

LIBRARY OPTIONS
GH = Gingival Height
CH = Cement Height
IG = Adaptor 3mm
 α_s = Standard maximum angulation
 α_c = Captive maximum angulation
 α_{di} = Direct to implant maximum angulation
 α_{dp} = Dynamic Premilled maximum angulation
R = Rotational / Non-Engaging
NR = Non Rotational / Engaging

STANDARD DYNAMIC TIBASE®															
	GINGIVAL HEIGHT	α_s	α_c	GINGIVAL HEIGHT	α_s	α_c	GINGIVAL HEIGHT	α_s	α_c	GINGIVAL HEIGHT	α_s	α_c	GINGIVAL HEIGHT	α_s	α_c
	0,3 mm			mm			mm			mm			mm		
R	31.323.010.01-2	45°	29°	-	-	-	-	-	-	-	-	-	-	-	-
NR	31.313.010.01-2			-			-			-			-		

DYNAMIC 3TIBASE®				
	GINGIVAL HEIGHT	α_s	α_s	α_s
		CH=5mm	CH= 7mm	CH= 9mm
R	-	-	-	-
NR	-	-	-	-

DYNAMIC μ SCANBODY (LAB/CLIN)				DIGITAL ANALOG
SCANBODY	HEIGHT mm	ADAPTOR	SCREWDRIVER ADAPTOR	DIGITAL ANALOG
52.410.115.01-2	10	50.313.010.01-2	43.621.410.01-2	34.613.010.01-2
		50.313.010.04-2 (IG=3mm)	43.624.410.01-2	
52.412.115.01-2	12			

DYNAMIC MILLING TOOL		
DYNAMIC MILLING TOOL	SHANK	α_{di}
33.390.716.01-2	3	30°
33.490.716.01-2	4	
33.690.716.01-2	6	

DYNAMIC SCREWS			
DYNAMIC SCREW	HIGH DYNAMIC SCREW	DYNAMIC SCREWDRIVER	SCREWDRIVER LENGTH (mm)
41.318.065.01-2	-	43.618.201.01-2	18
		43.624.201.01-2	24
		43.632.201.01-2	32

STRAIGHT SCREWS	
STRAIGHT SCREW	SCREWDRIVER Hex. 1.20
40.318.003.01-2	43.601.103.02-2

ANALOG	LAB SCANBODY
22.613.010.01-2	30.413.002.01-2

MULTI-UNIT				
	GINGIVAL HEIGHT	GINGIVAL HEIGHT	GINGIVAL HEIGHT	GINGIVAL HEIGHT
	1 mm	2 mm	3 mm	4 mm
R	42.303.010.01-2	42.303.010.02-2	42.303.010.03-2	42.303.010.04-2

LIBRARY OPTIONS
GH = Gingival Height
CH = Cement Height
IG = Adaptor 3mm
 α_s = Standard maximum angulation
 α_c = Captive maximum angulation
 α_{di} = Direct to implant maximum angulation
 α_{dp} = Dynamic Premilled maximum angulation
R = Rotational / Non-Engaging
NR = Non Rotational / Engaging

COMPATIBLE with 0011

STANDARD DYNAMIC TIBASE®															
	GINGIVAL HEIGHT	α_s	α_c	GINGIVAL HEIGHT	α_s	α_c	GINGIVAL HEIGHT	α_s	α_c	GINGIVAL HEIGHT	α_s	α_c	GINGIVAL HEIGHT	α_s	α_c
	0,3 mm			mm			mm			mm			mm		
R	31.322.011.01-2	25°	29°	-	-	-	-	-	-	-	-	-	-	-	-
NR	31.312.011.01-2			-	-	-	-	-	-	-	-	-	-	-	-

DYNAMIC 3TIBASE®									
	GINGIVAL HEIGHT	α_s	α_s	α_s	GINGIVAL HEIGHT	α_s	α_s	α_s	
	2mm	CH=5mm	CH= 7mm	CH= 9mm	3mm	CH=5mm	CH= 7mm	CH= 9mm	
R	-	25°	20°	15°	-	25°	20°	10°	-
NR	31.312.011.23-2				31.312.011.24-2				-

DYNAMIC μ SCANBODY (LAB/CLIN)					DIGITAL ANALOG		DYNAMIC MILLING TOOL		
SCANBODY	HEIGHT mm	ADAPTOR	SCREWDRIVER ADAPTOR	DIGITAL ANALOG	DYNAMIC MILLING TOOL	SHANK	α_{di}		
52.410.108.01-2	10	50.312.011.01-2	43.621.410.01-2 43.624.410.01-2	34.612.011.01-2	33.345.804.01-2	3	20°		
					33.445.804.01-2	4			
52.412.108.01-2	12				33.645.804.01-2	6			

DYNAMIC SCREWS				STRAIGHT SCREWS		ANALOG		LAB SCANBODY	
DYNAMIC SCREW	HIGH DYNAMIC SCREW	DYNAMIC SCREWDRIVER	SCREWDRIVER LENGTH (mm)	STRAIGHT SCREW	SCREWDRIVER Hex. 1.27				
41.316.094.01-2	-	43.618.201.01-2	18	40.316.005.04-2	43.601.105.01-2	-			30.412.001.01-2
		43.624.201.01-2	24						
		43.632.201.01-2	32						

LIBRARY OPTIONS
GH = Gingival Height
CH = Cement Height
IG = Adaptor 3mm
 α_s = Standard maximum angulation
 α_c = Captive maximum angulation
 α_{di} = Direct to implant maximum angulation
 α_{dp} = Dynamic Premilled maximum angulation
R = Rotational / Non-Engaging
NR = Non Rotational / Engaging

COMPATIBLE with 0012

STANDARD DYNAMIC TIBASE®															
	GINGIVAL HEIGHT	α_s	α_c	GINGIVAL HEIGHT	α_s	α_c	GINGIVAL HEIGHT	α_s	α_c	GINGIVAL HEIGHT	α_s	α_c	GINGIVAL HEIGHT	α_s	α_c
	0,3 mm			mm			mm			mm			mm		
R	31.323.012.01-2	25°	30°	-	-	-	-	-	-	-	-	-	-	-	-
NR	31.313.012.01-2			-	-	-	-	-	-	-	-	-	-	-	-

DYNAMIC 3TIBASE®													
	GINGIVAL HEIGHT	α_s	α_s	α_s	GINGIVAL HEIGHT	α_s	α_s	α_s	GINGIVAL HEIGHT	α_s	α_s	α_s	
	0,3 mm	CH=5mm	CH= 7mm	CH= 9mm	2 mm	CH=5mm	CH= 7mm	CH= 9mm	3mm	CH=5mm	CH= 7mm	CH= 9mm	
R	-	25°	25°	15°	-	25°	20°	15°	-	25°	20°	10°	-
NR	31.313.012.21-2				31.313.012.23-2				31.313.012.24-2				-

DYNAMIC μ SCANBODY (LAB/CLIN)					DIGITAL ANALOG		DYNAMIC MILLING TOOL		
SCANBODY	HEIGHT mm	ADAPTOR	SCREWDRIVER ADAPTOR	DIGITAL ANALOG	DYNAMIC MILLING TOOL	SHANK	α_{di}		
52.410.109.01-2	10	50.313.012.01-2	43.621.410.01-2 43.624.410.01-2	34.613.012.01-2	33.345.804.01-2	3	20°		
					33.445.804.01-2	4			
52.412.109.01-2	12				33.645.804.01-2	6			

DYNAMIC SCREWS				STRAIGHT SCREWS		ANALOG		LAB SCANBODY	
DYNAMIC SCREW	HIGH DYNAMIC SCREW	DYNAMIC SCREWDRIVER	SCREWDRIVER LENGTH (mm)	STRAIGHT SCREW	SCREWDRIVER Hex. 1.27				
41.316.094.01-2	-	43.618.201.01-2	18	40.316.005.04-2	43.601.105.01-2	-			30.413.002.01-2
		43.624.201.01-2	24						
		43.632.201.01-2	32						

LIBRARY OPTIONS
GH = Gingival Height
CH = Cement Height
IG = Adaptor 3mm
 α_s = Standard maximum angulation
 α_c = Captive maximum angulation
 α_{di} = Direct to implant maximum angulation
 α_{dp} = Dynamic Premilled maximum angulation
R = Rotational / Non-Engaging
NR = Non Rotational / Engaging

COMPATIBLE with 0013

STANDARD DYNAMIC TIBASE®															
	GINGIVAL HEIGHT	α_s	α_c	GINGIVAL HEIGHT	α_s	α_c	GINGIVAL HEIGHT	α_s	α_c	GINGIVAL HEIGHT	α_s	α_c	GINGIVAL HEIGHT	α_s	α_c
	0,7 mm			mm			mm			mm			mm		
R	31.323.013.01-2	43°	23°	-	-	-	-	-	-	-	-	-	-	-	-
NR	31.313.013.01-2			-	-	-	-	-	-	-	-	-	-	-	-

DYNAMIC 3TIBASE®				
	GINGIVAL HEIGHT	α_s	α_s	α_s
		CH=5mm	CH=7mm	CH=9mm
R	-	-	-	-
NR	-	-	-	-

DYNAMIC μ SCANBODY (LAB/CLIN)				DIGITAL ANALOG
SCANBODY	HEIGHT mm	ADAPTOR	SCREWDRIVER ADAPTOR	DIGITAL ANALOG
-	-	-	-	-
-	-	-	-	-

DYNAMIC MILLING TOOL		
DYNAMIC MILLING TOOL	SHANK	α_{di}
-	-	-
-	-	-

DYNAMIC SCREWS			
DYNAMIC SCREW	HIGH DYNAMIC SCREW	DYNAMIC SCREWDRIVER	SCREWDRIVER LENGTH (mm)
41.320.074.01-2	-	43.618.201.01-2	18
		43.624.201.01-2	24
		43.632.201.01-2	32

STRAIGHT SCREWS	
STRAIGHT SCREW	SCREWDRIVER TORX T6
40.320.007.02-2	43.601.107.01-2

ANALOG	LAB SCANBODY
-	30.413.002.01-2

LIBRARY OPTIONS
GH = Gingival Height
CH = Cement Height
IG = Adaptor 3mm
 α_s = Standard maximum angulation
 α_c = Captive maximum angulation
 α_{di} = Direct to implant maximum angulation
 α_{dp} = Dynamic Premilled maximum angulation
R = Rotational / Non-Engaging
NR = Non Rotational / Engaging

COMPATIBLE with 0014

STANDARD DYNAMIC TIBASE®															
	GINGIVAL HEIGHT	α_s	α_c	GINGIVAL HEIGHT	α_s	α_c	GINGIVAL HEIGHT	α_s	α_c	GINGIVAL HEIGHT	α_s	α_c	GINGIVAL HEIGHT	α_s	α_c
	1,2 mm			2 mm			3 mm			mm			mm		
R	31.322.014.01-2	41°	23°	31.322.014.02-2	25°	17°	-	20°	25°	-	-	-	-	-	-
NR	31.312.014.01-2			31.312.014.02-2			31.312.014.03-2			-			-		

DYNAMIC 3TIBASE®				
	GINGIVAL HEIGHT	α_s	α_s	α_s
		CH=5mm	CH=7mm	CH=9mm
R	-	-	-	-
NR	-	-	-	-

DYNAMIC μ SCANBODY (LAB/CLIN)				DIGITAL ANALOG
SCANBODY	HEIGHT mm	ADAPTOR	SCREWDRIVER ADAPTOR	DIGITAL ANALOG
52.410.128.01-2	10	50.312.014.03-2 (IG=3mm)	43.621.415.01-2	34.612.014.01-2
-	-			
-	-			

DYNAMIC MILLING TOOL			SCANALOG
DYNAMIC MILLING TOOL	SHANK	α_{di}	
33.345.804.01-2	3	25°	23.412.014.01-2
33.445.804.01-2	4		
33.645.804.01-2	6		

DYNAMIC SCREWS			
DYNAMIC SCREW	HIGH DYNAMIC SCREW	DYNAMIC SCREWDRIVER	SCREWDRIVER LENGTH (mm)
41.314.067.01-2	41.314.105.01-2	43.618.201.01-2	18
		43.624.201.01-2	24
		43.632.201.01-2	32

STRAIGHT SCREWS	
STRAIGHT SCREW	SCREWDRIVER Hex. 1.20
40.314.003.04-2	43.601.103.02-2

ANALOG	LAB SCANBODY
-	30.412.001.01-2

MULTI-UNIT				
	GINGIVAL HEIGHT	GINGIVAL HEIGHT	GINGIVAL HEIGHT	GINGIVAL HEIGHT
	1 mm	2 mm	3 mm	4 mm
R	-	42.302.014.02-2	42.302.014.03-2	42.302.014.04-2

LIBRARY OPTIONS
GH = Gingival Height
CH = Cement Height
IG = Adaptor 3mm
 α_s = Standard maximum angulation
 α_c = Captive maximum angulation
 α_{di} = Direct to implant maximum angulation
 α_{dp} = Dynamic Premilled maximum angulation
R = Rotational / Non-Engaging
NR = Non Rotational / Engaging

COMPATIBLE with 0015

STANDARD DYNAMIC TIBASE®															
	GINGIVAL HEIGHT	α_s	α_c	GINGIVAL HEIGHT	α_s	α_c	GINGIVAL HEIGHT	α_s	α_c	GINGIVAL HEIGHT	α_s	α_c	GINGIVAL HEIGHT	α_s	α_c
	1,7 mm			2,5 mm			3 mm			4 mm			5 mm		
R	31.323.015.01-2	43°	23°	31.323.015.02-2	25°	15°	31.323.015.03-2	25°	-	31.323.015.04-2	20°	-	31.323.015.05-2	15°	-
NR	31.313.015.01-2			31.313.015.02-2			31.313.015.03-2			31.313.015.04-2			31.313.015.05-2		

DYNAMIC 3TIBASE®													
	GINGIVAL HEIGHT	α_s	α_s	α_s	GINGIVAL HEIGHT	α_s	α_s	α_s	GINGIVAL HEIGHT	GINGIVAL HEIGHT	α_s	α_s	α_s
	1 mm	CH=5mm	CH= 7mm	CH= 9mm	1,7 mm	CH=5mm	CH= 7mm	CH= 9mm	2,5 mm	3,5 mm	CH=5mm	CH= 7mm	CH= 9mm
R	-	30°	25°	200°	31.323.015.21-2	30°	25°	10°	31.323.015.22-2	31.313.015.26-2	25°	20°	10°
NR	31.313.015.27-2				31.313.015.21-2				31.313.015.22-2				

DYNAMIC μ SCANBODY (LAB/CLIN)					DIGITAL ANALOG		DYNAMIC MILLING TOOL		SCANALOG	
SCANBODY	HEIGHT mm	ADAPTOR	SCREWDRIVER ADAPTOR	DIGITAL ANALOG	DYNAMIC MILLING TOOL	SHANK	α_{di}			
52.410.104.01-2	10	50.313.015.01-2	43.621.410.01-2	34.613.015.01-2	33.390.805.01-2	3	25°	23.413.015.01-2		
		50.313.015.03-2 (IG=3mm)	43.624.410.01-2		33.490.805.01-2	4				
52.412.104.01-2	12				33.690.805.01-2	6				

DYNAMIC SCREWS				STRAIGHT SCREWS		ANALOG		LAB SCANBODY	
DYNAMIC SCREW	HIGH DYNAMIC SCREW	DYNAMIC SCREWDRIVER	SCREWDRIVER LENGTH (mm)	STRAIGHT SCREW	SCREWDRIVER Hex. 1.20				
41.318.075.01-2	-	43.618.201.01-2	18	40.318.003.02-2	43.601.103.02-2	-		30.413.002.01-2	
		43.624.201.01-2	24						
		43.632.201.01-2	32						

MULTI-UNIT				
	GINGIVAL HEIGHT	GINGIVAL HEIGHT	GINGIVAL HEIGHT	GINGIVAL HEIGHT
	1 mm	2 mm	3 mm	4 mm
R	42.303.015.01-2	42.303.015.02-2	42.303.015.03-2	42.303.015.04-2

LIBRARY OPTIONS
GH = Gingival Height
CH = Cement Height
IG = Adaptor 3mm
 α_s = Standard maximum angulation
 α_c = Captive maximum angulation
 α_{di} = Direct to implant maximum angulation
 α_{dp} = Dynamic Premilled maximum angulation
R = Rotational / Non-Engaging
NR = Non Rotational / Engaging

COMPATIBLE with 0016

STANDARD DYNAMIC TIBASE®															
	GINGIVAL HEIGHT	α_s	α_c	GINGIVAL HEIGHT	α_s	α_c	GINGIVAL HEIGHT	α_s	α_c	GINGIVAL HEIGHT	α_s	α_c	GINGIVAL HEIGHT	α_s	α_c
	0,8 mm			1,5 mm			mm			mm			mm		
R	31.322.016.01-2	45°	28°	31.322.016.02-2	25°	-	-	-	-	-	-	-	-	-	-
NR	31.312.016.01-2			31.312.016.02-2			-			-			-		

DYNAMIC 3TIBASE®				
	GINGIVAL HEIGHT	α_s	α_s	α_s
	1,5 mm	CH=5mm	CH= 7mm	CH= 9mm
R	-	25°	25°	15°
NR	31.312.016.22-2			

DYNAMIC μ SCANBODY (LAB/CLIN)					DIGITAL ANALOG		DYNAMIC MILLING TOOL		
SCANBODY	HEIGHT mm	ADAPTOR	SCREWDRIVER ADAPTOR	DIGITAL ANALOG	DYNAMIC MILLING TOOL	SHANK	α_{di}		
52.408.106.01-2	8	50.312.016.01-2	43.621.410.01-2	34.610.016.01-2	33.360.754.01-2	3	25°		
52.410.106.01-2	10	50.312.016.04-2 (IG=3mm)	43.624.410.01-2		33.460.754.01-2	4			
52.412.106.01-2	12				33.660.754.01-2	6			

DYNAMIC SCREWS				STRAIGHT SCREWS		ANALOG		LAB SCANBODY	
DYNAMIC SCREW	HIGH DYNAMIC SCREW	DYNAMIC SCREWDRIVER	SCREWDRIVER LENGTH (mm)	STRAIGHT SCREW	SCREWDRIVER Hex. 1.27				
41.316.071.01-2	-	43.618.201.01-2	18	40.316.005.05-2	43.601.105.01-2	-		30.412.001.01-2	
		43.624.201.01-2	24						
		43.632.201.01-2	32						

MULTI-UNIT				
	GINGIVAL HEIGHT	GINGIVAL HEIGHT	GINGIVAL HEIGHT	GINGIVAL HEIGHT
	1 mm	2 mm	3 mm	4 mm
R	-	42.302.016.02-2	-	-

LIBRARY OPTIONS
GH = Gingival Height
CH = Cement Height
IG = Adaptor 3mm
 α_s = Standard maximum angulation
 α_c = Captive maximum angulation
 α_{di} = Direct to implant maximum angulation
 α_{dp} = Dynamic Premilled maximum angulation
R = Rotational / Non-Engaging
NR = Non Rotational / Engaging

COMPATIBLE with 0017

STANDARD DYNAMIC TIBASE®															
	GINGIVAL HEIGHT	α_s	α_c	GINGIVAL HEIGHT	α_s	α_c	GINGIVAL HEIGHT	α_s	α_c	GINGIVAL HEIGHT	α_s	α_c	GINGIVAL HEIGHT	α_s	α_c
	0,7 mm			1,5 mm			mm			mm			mm		
R	31.323.017.01-2	45°	24°	31.323.017.02-2	25°	-	-	-	-	-	-	-	-	-	-
NR	31.313.017.01-2			31.313.017.02-2			-	-	-	-	-	-	-	-	-

DYNAMIC 3TIBASE®				
	GINGIVAL HEIGHT	α_s	α_s	α_s
	0,7 mm	CH=5mm	CH= 7mm	CH= 9mm
R	31.323.017.21-2	30°	25°	15°
NR	31.313.017.21-2			

DYNAMIC μ SCANBODY (LAB/CLIN)				DIGITAL ANALOG
SCANBODY	HEIGHT mm	ADAPTOR	SCREWDRIVER ADAPTOR	DIGITAL ANALOG
52.408.101.01-2	8	50.313.017.01-2	43.621.410.01-2	34.613.017.01-2
52.410.101.01-2	10	50.313.017.04-2 (IG=3mm)	43.624.410.01-2	
52.412.101.01-2	12			

DYNAMIC MILLING TOOL		
DYNAMIC MILLING TOOL	SHANK	α_{di}
33.360.756.01-2	3	30°
33.460.756.01-2	4	
33.660.756.01-2	6	

DYNAMIC SCREWS			
DYNAMIC SCREW	HIGH DYNAMIC SCREW	DYNAMIC SCREWDRIVER	SCREWDRIVER LENGTH (mm)
41.317.073.01-2	-	43.618.201.01-2	18
		43.624.201.01-2	24
		43.632.201.01-2	32

STRAIGHT SCREWS	
STRAIGHT SCREW	SCREWDRIVER Hex. 1.27
40.317.005.01-2	43.601.105.01-2

ANALOG	LAB SCANBODY
-	30.413.002.01-2

MULTI-UNIT				
	GINGIVAL HEIGHT	GINGIVAL HEIGHT	GINGIVAL HEIGHT	GINGIVAL HEIGHT
	1 mm	2 mm	3 mm	4 mm
R	-	42.303.017.02-2	-	-

LIBRARY OPTIONS

GH = Gingival Height
CH = Cement Height
IG = Adaptor 3mm

α_s = Standard maximum angulation
 α_c = Captive maximum angulation
 α_{di} = Direct to implant maximum angulation
 α_{dp} = Dynamic Premilled maximum angulation

R = Rotational / Non-Engaging
NR = Non Rotational / Engaging

COMPATIBLE with 0018

STANDARD DYNAMIC TIBASE®															
	GINGIVAL HEIGHT	α_s	α_c	GINGIVAL HEIGHT	α_s	α_c	GINGIVAL HEIGHT	α_s	α_c	GINGIVAL HEIGHT	α_s	α_c	GINGIVAL HEIGHT	α_s	α_c
	1,2 mm			mm			mm			mm			mm		
R	31.324.018.01-2	39°	18°	-	-	-	-	-	-	-	-	-	-	-	-
NR	31.314.018.01-2			-	-	-	-	-	-	-	-	-	-	-	-

DYNAMIC 3TIBASE®				
	GINGIVAL HEIGHT	α_s	α_s	α_s
		CH=5mm	CH= 7mm	CH= 9mm
R	-	-	-	-
NR	-			

DYNAMIC μ SCANBODY (LAB/CLIN)				DIGITAL ANALOG
SCANBODY	HEIGHT mm	ADAPTOR	SCREWDRIVER ADAPTOR	DIGITAL ANALOG
52.410.102.01-2	10	50.314.018.01-2	43.621.410.01-2	34.614.018.01-2
			43.624.410.01-2	
52.412.102.01-2	12			

DYNAMIC MILLING TOOL		
DYNAMIC MILLING TOOL	SHANK	α_{di}
33.360.756.01-2	3	30°
33.460.756.01-2	4	
33.660.756.01-2	6	

DYNAMIC SCREWS			
DYNAMIC SCREW	HIGH DYNAMIC SCREW	DYNAMIC SCREWDRIVER	SCREWDRIVER LENGTH (mm)
41.317.073.01-2	-	43.618.201.01-2	18
		43.624.201.01-2	24
		43.632.201.01-2	32

STRAIGHT SCREWS	
STRAIGHT SCREW	SCREWDRIVER Hex. 1.27
40.317.005.01-2	43.601.105.01-2

ANALOG	LAB SCANBODY
-	30.413.002.01-2

LIBRARY OPTIONS

GH = Gingival Height
CH = Cement Height
IG = Adaptor 3mm

α_s = Standard maximum angulation
 α_c = Captive maximum angulation
 α_{di} = Direct to implant maximum angulation
 α_{dp} = Dynamic Premilled maximum angulation

R = Rotational / Non-Engaging
NR = Non Rotational / Engaging

STANDARD DYNAMIC TIBASE®															
	GINGIVAL HEIGHT	α_s	α_c	GINGIVAL HEIGHT	α_s	α_c	GINGIVAL HEIGHT	α_s	α_c	GINGIVAL HEIGHT	α_s	α_c	GINGIVAL HEIGHT	α_s	α_c
	0,8 mm			mm			mm			mm			mm		
R	31.322.019.01-2	45°	30°	-	-	-	-	-	-	-	-	-	-	-	-
NR	31.312.019.01-2			-	-	-	-	-	-	-	-	-	-	-	-

DYNAMIC 3TIBASE®				
	GINGIVAL HEIGHT	α_s	α_s	α_s
		CH=5mm	CH= 7mm	CH= 9mm
R	-	-	-	-
NR	-	-	-	-

DYNAMIC μSCANBODY (LAB/CLIN)				DIGITAL ANALOG
SCANBODY	HEIGHT mm	ADAPTOR	SCREWDRIVER ADAPTOR	DIGITAL ANALOG
52.410.105.01-2	10	50.312.019.01-2	43.621.410.01-2 43.624.410.01-2	34.612.019.01-2
52.412.105.01-2	12			

DYNAMIC MILLING TOOL			
DYNAMIC MILLING TOOL	SHANK	α_{di}	
33.360.754.01-2	3	25°	
33.460.754.01-2	4		
33.660.754.01-2	6		

DYNAMIC SCREWS			
DYNAMIC SCREW	HIGH DYNAMIC SCREW	DYNAMIC SCREWDRIVER	SCREWDRIVER LENGTH (mm)
41.316.071.01-2	-	43.618.201.01-2	18
		43.624.201.01-2	24
		43.632.201.01-2	32

STRAIGHT SCREWS	
STRAIGHT SCREW	SCREWDRIVER Hex. 1.27
40.316.005.05-2	43.601.105.01-2

ANALOG	LAB SCANBODY
-	30.412.001.01-2

LIBRARY OPTIONS
GH = Gingival Height
CH = Cement Height
IG = Adaptor 3mm
 α_s = Standard maximum angulation
 α_c = Captive maximum angulation
 α_{di} = Direct to implant maximum angulation
 α_{dp} = Dynamic Premilled maximum angulation
R = Rotational / Non-Engaging
NR = Non Rotational / Engaging

STANDARD DYNAMIC TIBASE®															
	GINGIVAL HEIGHT	α_s	α_c	GINGIVAL HEIGHT	α_s	α_c	GINGIVAL HEIGHT	α_s	α_c	GINGIVAL HEIGHT	α_s	α_c	GINGIVAL HEIGHT	α_s	α_c
	0,6 mm			mm			mm			mm			mm		
R	31.323.020.01-2	45°	30°	-	-	-	-	-	-	-	-	-	-	-	-
NR	-			-	-	-	-	-	-	-	-	-	-	-	-

DYNAMIC 3TIBASE®				
	GINGIVAL HEIGHT	α_s	α_s	α_s
		CH=5mm	CH= 7mm	CH= 9mm
R	-	-	-	-
NR	-	-	-	-

DYNAMIC μSCANBODY (LAB/CLIN)				DIGITAL ANALOG
SCANBODY	HEIGHT mm	ADAPTOR	SCREWDRIVER ADAPTOR	DIGITAL ANALOG
52.408.112.01-2	8	50.313.020.01-2	43.620.411.01-2	34.613.020.01-2
-	10			
-	12			

DYNAMIC MILLING TOOL		
DYNAMIC MILLING TOOL	SHANK	α_{di}
33.390.716.01-2	3	30°
33.490.716.01-2	4	
33.690.716.01-2	6	

DYNAMIC SCREWS			
DYNAMIC SCREW	HIGH DYNAMIC SCREW	DYNAMIC SCREWDRIVER	SCREWDRIVER LENGTH (mm)
41.316.044.01-2	-	43.618.201.01-2	18
		43.624.201.01-2	24
		43.632.201.01-2	32

STRAIGHT SCREWS	
STRAIGHT SCREW	SCREWDRIVER Hex. 1.27
40.316.005.06-2	43.601.105.01-2

ANALOG	LAB SCANBODY
-	30.413.005.01-2

LIBRARY OPTIONS
GH = Gingival Height
CH = Cement Height
IG = Adaptor 3mm
 α_s = Standard maximum angulation
 α_c = Captive maximum angulation
 α_{di} = Direct to implant maximum angulation
 α_{dp} = Dynamic Premilled maximum angulation
R = Rotational / Non-Engaging
NR = Non Rotational / Engaging

STANDARD DYNAMIC TIBASE®															
	GINGIVAL HEIGHT	α_s	α_c	GINGIVAL HEIGHT	α_s	α_c	GINGIVAL HEIGHT	α_s	α_c	GINGIVAL HEIGHT	α_s	α_c	GINGIVAL HEIGHT	α_s	α_c
	1,5 mm			2 mm			3 mm			4 mm			5 mm		
R	31.322.021.01-2	43°	24°	31.322.021.02-2	25°	20°	31.322.021.03-2	20°	25°	31.322.021.04-2	15°	25°	31.322.021.05-2	15°	20°
NR	31.312.021.01-2			31.312.021.02-2			31.312.021.03-2			31.312.021.04-2			31.312.021.05-2		

DYNAMIC 3TIBASE®									
	GINGIVAL HEIGHT	α_s	α_s	α_s	GINGIVAL HEIGHT	α_s	α_s	α_s	
	1,5 mm	CH=5mm	CH= 7mm	CH= 9mm	3 mm	CH=5mm	H= 7mm	CH= 9mm	
R	31.322.021.21-2	25°	20°	10°	31.322.021.23-2	25°	20°	15°	
NR	31.312.021.21-2				31.312.021.23-2				

DYNAMIC μ SCANBODY (LAB/CLIN)					DIGITAL ANALOG		DYNAMIC MILLING TOOL			SCANALOG	
SCANBODY	HEIGHT mm	ADAPTOR	SCREWDRIVER ADAPTOR	DIGITAL ANALOG	DYNAMIC MILLING TOOL	SHANK	α_{di}				
52.410.103.01-2	10	50.312.021.01-2	43.621.410.01-2 43.624.410.01-2	34.612.021.01-2	33.335.754.01-2	3	25°	23.412.021.01-2			
					33.435.754.01-2	4					
52.412.103.01-2	12	50.312.021.03-2 (IG=3mm)			33.635.754.01-2	6					

DYNAMIC SCREWS				STRAIGHT SCREWS		ANALOG		LAB SCANBODY	
DYNAMIC SCREW	HIGH DYNAMIC SCREW	DYNAMIC SCREWDRIVER	SCREWDRIVER LENGTH (mm)	STRAIGHT SCREW	SCREWDRIVER UNIGRIP				
41.316.073.01-2	41.316.108.01-2	43.618.201.01-2	18	40.316.008.02-2	43.601.108.01-2	22.612.021.01-2		30.412.001.01-2	
		43.624.201.01-2	24						
		43.632.201.01-2	32						

MULTI-UNIT				
	GINGIVAL HEIGHT	GINGIVAL HEIGHT	GINGIVAL HEIGHT	GINGIVAL HEIGHT
	1 mm	2 mm	3 mm	4 mm
R	42.302.021.01-2	42.302.021.02-2	42.302.021.03-2	42.302.021.04-2

LIBRARY OPTIONS
GH = Gingival Height
CH = Cement Height
IG = Adaptor 3mm
 α_s = Standard maximum angulation
 α_c = Captive maximum angulation
 α_{di} = Direct to implant maximum angulation
 α_{dp} = Dynamic Premilled maximum angulation
R = Rotational / Non-Engaging
NR = Non Rotational / Engaging

STANDARD DYNAMIC TIBASE®															
	GINGIVAL HEIGHT	α_s	α_c	GINGIVAL HEIGHT	α_s	α_c	GINGIVAL HEIGHT	α_s	α_c	GINGIVAL HEIGHT	α_s	α_c	GINGIVAL HEIGHT	α_s	α_c
	1,3 mm			2 mm			3 mm			4 mm			5 mm		
R	31.323.022.01-2	40°	19°	31.323.022.02-2	25°	14°	31.323.022.03-2	20°	30°	31.323.022.04-2	15	30	31.323.022.05-2	15°	20°
NR	31.313.022.01-2			31.313.022.02-2			31.313.022.03-2			31.313.022.04-2			31.313.022.05-2		

DYNAMIC 3TIBASE®									
	GINGIVAL HEIGHT	α_s	α_s	α_s	GINGIVAL HEIGHT	α_s	α_s	α_s	
	1,3 mm	CH=5mm	CH= 7mm	CH= 9mm	3 mm	CH=5mm	CH= 7mm	CH= 9mm	
R	31.323.022.21-2	30°	25°	10°	31.323.022.23-2	20°	20°	10°	
NR	31.313.022.21-2				31.313.022.23-2				

DYNAMIC μ SCANBODY (LAB/CLIN)					DIGITAL ANALOG		DYNAMIC MILLING TOOL			SCANALOG	
SCANBODY	HEIGHT mm	ADAPTOR	SCREWDRIVER ADAPTOR	DIGITAL ANALOG	DYNAMIC MILLING TOOL	SHANK	α_{di}				
52.408.101.01-2	8	50.313.022.01-2	43.621.410.01-2 43.624.410.01-2	34.613.022.01-2	33.335.758.01-2	3	30°	23.413.022.01-2			
52.410.101.01-2	10				33.435.758.01-2	4					
52.412.101.01-2	12	50.313.022.03-2 (IG=3mm)			33.635.758.01-2	6					

DYNAMIC SCREWS				STRAIGHT SCREWS		ANALOG		LAB SCANBODY	
DYNAMIC SCREW	HIGH DYNAMIC SCREW	DYNAMIC SCREWDRIVER	SCREWDRIVER LENGTH (mm)	STRAIGHT SCREW	SCREWDRIVER UNIGRIP				
41.320.075.01-2	41.320.117.01-2	43.618.201.01-2	18	40.320.008.02-2	43.601.108.01-2	22.613.022.01-2		30.413.002.01-2	
		43.624.201.01-2	24						
		43.632.201.01-2	32						

MULTI-UNIT				
	GINGIVAL HEIGHT	GINGIVAL HEIGHT	GINGIVAL HEIGHT	GINGIVAL HEIGHT
	1 mm	2 mm	3 mm	4 mm
R	42.303.022.01-2	42.303.022.02-2	42.303.022.03-2	42.303.022.04-2

LIBRARY OPTIONS
GH = Gingival Height
CH = Cement Height
IG = Adaptor 3mm
 α_s = Standard maximum angulation
 α_c = Captive maximum angulation
 α_{di} = Direct to implant maximum angulation
 α_{dp} = Dynamic Premilled maximum angulation
R = Rotational / Non-Engaging
NR = Non Rotational / Engaging

STANDARD DYNAMIC TIBASE®

	GINGIVAL HEIGHT 0,3 mm	α_s	α_c	GINGIVAL HEIGHT mm	α_s	α_c	GINGIVAL HEIGHT mm	α_s	α_c	GINGIVAL HEIGHT mm	α_s	α_c	GINGIVAL HEIGHT mm	α_s	α_c
R	31.322.023.01-2	45°	30°	-	-	-	-	-	-	-	-	-	-	-	-
NR	31.312.023.01-2			-	-	-	-	-	-	-	-	-	-	-	-

DYNAMIC 3TIBASE®

	GINGIVAL HEIGHT	α_s	α_s	α_s
		CH=5mm	CH=7mm	CH=9mm
R	-	-	-	-
NR	-	-	-	-

DYNAMIC μSCANBODY (LAB/CLIN)

SCANBODY	HEIGHT mm	ADAPTOR	SCREWDRIVER ADAPTOR	DIGITAL ANALOG
52.410.103.01-2	10	50.312.023.01-2	43.621.410.01-2 43.624.410.01-2	34.612.023.01-2
52.412.103.01-2	12			

DIGITAL ANALOG

DYNAMIC MILLING TOOL

DYNAMIC MILLING TOOL	SHANK	α_{di}
33.390.805.01-2	3	25°
33.490.805.01-2	4	
33.690.805.01-2	6	

SCANALOG

23.412.023.01-2

DYNAMIC SCREWS

DYNAMIC SCREW	HIGH DYNAMIC SCREW	DYNAMIC SCREWDRIVER	SCREWDRIVER LENGTH (mm)
41.316.059.01-2	-	43.618.201.01-2	18
		43.624.201.01-2	24
		43.632.201.01-2	32

STRAIGHT SCREWS

STRAIGHT SCREW	SCREWDRIVER UNIGRIP
40.316.008.01-2	43.601.108.01-2

ANALOG	LAB SCANBODY
22.612.023.01-2	30.412.001.01-2

LIBRARY OPTIONS

GH = Gingival Height
CH = Cement Height
IG = Adaptor 3mm

α_s = Standard maximum angulation
 α_c = Captive maximum angulation
 α_{di} = Direct to implant maximum angulation
 α_{dp} = Dynamic Premilled maximum angulation

R = Rotational / Non-Engaging
NR = Non Rotational / Engaging

STANDARD DYNAMIC TIBASE®

	GINGIVAL HEIGHT 0,3 mm	α_s	α_c	GINGIVAL HEIGHT 0,5 mm	α_s	α_c	GINGIVAL HEIGHT mm	α_s	α_c	GINGIVAL HEIGHT mm	α_s	α_c	GINGIVAL HEIGHT mm	α_s	α_c
R	31.323.024.01-2	45°	30°	31.323.024.02-2	30°	30°	-	-	-	-	-	-	-	-	-
NR	31.313.024.01-2			31.313.024.02-2			-	-	-	-	-	-	-	-	-

DYNAMIC 3TIBASE®

	GINGIVAL HEIGHT 0,3 mm	GINGIVAL HEIGHT 0,5 mm	GINGIVAL HEIGHT 1 mm	GINGIVAL HEIGHT 2 mm	α_s	α_s	α_s	GINGIVAL HEIGHT 3 mm	GINGIVAL HEIGHT 4 mm	α_s	α_s	α_s
					CH 5mm	CH 7mm	CH 9mm			CH 5mm	CH 7mm	CH 9mm
R	31.323.024.21-2	31.323.024.22-2	31.323.024.23-2	31.323.024.24-2	30°	25°	10°	31.323.024.25-2	31.323.024.26-2	25°	20°	15°
NR			31.313.024.23-2	31.313.024.24-2				31.313.024.25-2	31.313.024.26-2			

DYNAMIC μSCANBODY (LAB/CLIN)

SCANBODY	HEIGHT mm	ADAPTOR	SCREWDRIVER ADAPTOR	DIGITAL ANALOG
52.408.101.01-2	8	50.313.024.01-2	43.621.410.01-2 43.624.410.01-2	34.613.024.01-2
52.410.101.01-2	10			
52.412.101.01-2	12			

DIGITAL ANALOG

DYNAMIC MILLING TOOL

DYNAMIC MILLING TOOL	SHANK	α_{di}
33.390.716.01-2	3	30°
33.490.716.01-2	4	
33.690.716.01-2	6	

SCANALOG

23.413.024.01-2

DYNAMIC SCREWS

DYNAMIC SCREW	HIGH DYNAMIC SCREW	DYNAMIC SCREWDRIVER	SCREWDRIVER LENGTH (mm)
41.320.060.01-2	-	43.618.201.01-2	18
		43.624.201.01-2	24
		43.632.201.01-2	32

STRAIGHT SCREWS

STRAIGHT SCREW	SCREWDRIVER UNIGRIP
40.320.008.01-2	43.601.108.01-2

ANALOG	LAB SCANBODY
22.613.024.01-2	30.413.002.01-2

MULTI-UNIT

	GINGIVAL HEIGHT 1 mm	GINGIVAL HEIGHT 2 mm	GINGIVAL HEIGHT 3 mm	GINGIVAL HEIGHT 4 mm
R	-	42.303.024.02-2	42.303.024.03-2	-

LIBRARY OPTIONS

GH = Gingival Height
CH = Cement Height
IG = Adaptor 3mm

α_s = Standard maximum angulation
 α_c = Captive maximum angulation
 α_{di} = Direct to implant maximum angulation
 α_{dp} = Dynamic Premilled maximum angulation

R = Rotational / Non-Engaging
NR = Non Rotational / Engaging

STANDARD DYNAMIC TIBASE®

	GINGIVAL HEIGHT 0,3 mm	α_s	α_c	GINGIVAL HEIGHT mm	α_s	α_c	GINGIVAL HEIGHT mm	α_s	α_c	GINGIVAL HEIGHT mm	α_s	α_c	GINGIVAL HEIGHT mm	α_s	α_c
R	31.323.025.01-2	45°	30°	-	-	-	-	-	-	-	-	-	-	-	-
NR	-			-	-	-	-	-	-	-	-	-	-	-	-

DYNAMIC 3TIBASE®

	GINGIVAL HEIGHT 0,3 mm	α_s CH=5mm	α_s CH= 7mm	α_s CH= 9mm
R	31.323.025.21-2	30°	25°	10°
NR	-			

DYNAMIC μSCANBODY (LAB/CLIN) DIGITAL ANALOG

SCANBODY	HEIGHT mm	ADAPTOR	SCREWDRIVER ADAPTOR	DIGITAL ANALOG
52.408.112.01-2	8	50.313.025.02-2	43.620.411.01-2	34.613.025.01-2
52.410.111.01-2	10	50.313.025.01-2	43.621.410.01-2 43.624.410.01-2	

DYNAMIC MILLING TOOL

DYNAMIC MILLING TOOL	SHANK	α_{di}
33.390.716.01-2	3	30°
33.490.716.01-2	4	
33.690.716.01-2	6	

SCANALOG

23.413.025.01-2

REFERENCE SCANBODY

SCANBODY	PEEK PINS	mm
54.322.025.31-2	49.414.000.01-2	6
	49.415.000.01-2	9
	49.416.000.01-2	13

DYNAMIC SCREWS

DYNAMIC SCREW	HIGH DYNAMIC SCREW	DYNAMIC SCREWDRIVER	SCREWDRIVER LENGTH (mm)
41.314.039.01-2	-	43.618.201.01-2	18
		43.624.201.01-2	24
		43.632.201.01-2	32

STRAIGHT SCREWS

STRAIGHT SCREW	SCREWDRIVER UNIGRIP
40.314.008.01-2	43.601.108.01-2

ANALOG	LAB SCANBODY
22.613.025.01-2	30.413.005.01-2

LIBRARY OPTIONS
GH = Gingival Height
CH = Cement Height
IG = Adaptor 3mm
 α_s = Standard maximum angulation
 α_c = Captive maximum angulation
 α_{di} = Direct to implant maximum angulation
 α_{dp} = Dynamic Premilled maximum angulation
R = Rotational / Non-Engaging
NR = Non Rotational / Engaging

STANDARD DYNAMIC TIBASE®

	GINGIVAL HEIGHT 0,5 mm	α_s	α_c	GINGIVAL HEIGHT 1,2 mm	α_s	α_c	GINGIVAL HEIGHT mm	α_s	α_c	GINGIVAL HEIGHT mm	α_s	α_c	GINGIVAL HEIGHT mm	α_s	α_c
R	31.322.026.01-2	45°	29°	31.322.026.02-2	25°	22°	-	-	-	-	-	-	-	-	-
NR	31.312.026.01-2			31.312.026.02-2			-	-	-	-	-	-	-	-	-

DYNAMIC 3TIBASE®

	GINGIVAL HEIGHT 0,5 mm	α_s CH=5mm	α_s CH= 7mm	α_s CH= 9mm
R	31.322.026.21-2	25°	20°	10°
NR	31.312.026.21-2			

DYNAMIC μSCANBODY (LAB/CLIN) DIGITAL ANALOG

SCANBODY	HEIGHT mm	ADAPTOR	SCREWDRIVER ADAPTOR	DIGITAL ANALOG
52.410.108.01-2	10	50.312.026.01-2	43.621.410.01-2 43.624.410.01-2	34.612.026.01-2
52.412.108.01-2	12			

DYNAMIC MILLING TOOL

DYNAMIC MILLING TOOL	SHANK	α_{di}
33.390.805.01-2	3	25°
33.490.805.01-2	4	
33.690.805.01-2	6	

DYNAMIC SCREWS

DYNAMIC SCREW	HIGH DYNAMIC SCREW	DYNAMIC SCREWDRIVER	SCREWDRIVER LENGTH (mm)
41.318.075.01-2	-	43.618.201.01-2	18
		43.624.201.01-2	24
		43.632.201.01-2	32

STRAIGHT SCREWS

STRAIGHT SCREW	SCREWDRIVER UNIGRIP
40.318.008.01-2	43.601.108.01-2

ANALOG	LAB SCANBODY
22.612.026.01-2	30.412.001.01-2

LIBRARY OPTIONS
GH = Gingival Height
CH = Cement Height
IG = Adaptor 3mm
 α_s = Standard maximum angulation
 α_c = Captive maximum angulation
 α_{di} = Direct to implant maximum angulation
 α_{dp} = Dynamic Premilled maximum angulation
R = Rotational / Non-Engaging
NR = Non Rotational / Engaging

STANDARD DYNAMIC TIBASE®															
	GINGIVAL HEIGHT	α_s	α_c	GINGIVAL HEIGHT	α_s	α_c	GINGIVAL HEIGHT	α_s	α_c	GINGIVAL HEIGHT	α_s	α_c	GINGIVAL HEIGHT	α_s	α_c
	0,3 mm			1,2 mm			mm			mm			mm		
R	31.323.027.01-2	35°	29°	31.323.027.02-2	25°	22°	-	-	-	-	-	-	-	-	-
NR	31.313.027.01-2			31.313.027.02-2			-	-	-	-	-	-	-	-	-

DYNAMIC 3TIBASE®				
	GINGIVAL HEIGHT	α_s	α_s	α_s
	0,3 mm	CH=5mm	CH= 7mm	CH= 9mm
R	31.323.027.21-2	25°	20°	10°
NR	31.313.027.21-2			

DYNAMIC μ SCANBODY (LAB/CLIN)				DIGITAL ANALOG
SCANBODY	HEIGHT mm	ADAPTOR	SCREWDRIVER ADAPTOR	DIGITAL ANALOG
52.410.109.01-2	10	50.313.027.01-2	43.621.410.01-2 43.624.410.01-2	34.613.027.01-2
52.412.109.01-2	12			

DYNAMIC MILLING TOOL		
DYNAMIC MILLING TOOL	SHANK	α_{di}
33.390.958.01-2	3	30°
33.490.958.01-2	4	
33.690.958.01-2	6	

DYNAMIC SCREWS			
DYNAMIC SCREW	HIGH DYNAMIC SCREW	DYNAMIC SCREWDRIVER	SCREWDRIVER LENGTH (mm)
41.320.090.01-2	-	43.618.201.01-2	18
		43.624.201.01-2	24
		43.632.201.01-2	32

STRAIGHT SCREWS	
STRAIGHT SCREW	SCREWDRIVER UNIGRIP
40.320.008.03-2	43.601.108.01-2

ANALOG	LAB SCANBODY
22.613.027.01-2	30.413.002.01-2

LIBRARY OPTIONS

GH = Gingival Height
CH = Cement Height
IG = Adaptor 3mm

α_s = Standard maximum angulation
 α_c = Captive maximum angulation
 α_{di} = Direct to implant maximum angulation
 α_{dp} = Dynamic Premilled maximum angulation

R = Rotational / Non-Engaging
NR = Non Rotational / Engaging

STANDARD DYNAMIC TIBASE®															
	GINGIVAL HEIGHT	α_s	α_c	GINGIVAL HEIGHT	α_s	α_c	GINGIVAL HEIGHT	α_s	α_c	GINGIVAL HEIGHT	α_s	α_c	GINGIVAL HEIGHT	α_s	α_c
	0,3 mm			mm			mm			mm			mm		
R	31.324.028.01-2	35°	30°	-	-	-	-	-	-	-	-	-	-	-	-
NR	31.314.028.01-2			-	-	-	-	-	-	-	-	-	-	-	-

DYNAMIC 3TIBASE®				
	GINGIVAL HEIGHT	α_s	α_s	α_s
		CH=5mm	CH= 7mm	CH= 9mm
R	-	-	-	-
NR	-	-	-	-

DYNAMIC μ SCANBODY (LAB/CLIN)				DIGITAL ANALOG
SCANBODY	HEIGHT mm	ADAPTOR	SCREWDRIVER ADAPTOR	DIGITAL ANALOG
52.410.109.01-2	10	50.314.028.01-2	43.621.410.01-2 43.624.410.01-2	34.614.028.01-2
52.412.109.01-2	12			

DYNAMIC MILLING TOOL		
DYNAMIC MILLING TOOL	SHANK	α_{di}
33.390.958.01-2	3	30°
33.490.958.01-2	4	
33.690.958.01-2	6	

DYNAMIC SCREWS			
DYNAMIC SCREW	HIGH DYNAMIC SCREW	DYNAMIC SCREWDRIVER	SCREWDRIVER LENGTH (mm)
41.320.090.01-2	-	43.618.201.01-2	18
		43.624.201.01-2	24
		43.632.201.01-2	32

STRAIGHT SCREWS	
STRAIGHT SCREW	SCREWDRIVER UNIGRIP
40.320.008.03-2	43.601.108.01-2

ANALOG	LAB SCANBODY
22.614.028.01-2	30.413.002.01-2

LIBRARY OPTIONS

GH = Gingival Height
CH = Cement Height
IG = Adaptor 3mm

α_s = Standard maximum angulation
 α_c = Captive maximum angulation
 α_{di} = Direct to implant maximum angulation
 α_{dp} = Dynamic Premilled maximum angulation

R = Rotational / Non-Engaging
NR = Non Rotational / Engaging

STANDARD DYNAMIC TIBASE®															
	GINGIVAL HEIGHT	α_s	α_c	GINGIVAL HEIGHT	α_s	α_c	GINGIVAL HEIGHT	α_s	α_c	GINGIVAL HEIGHT	α_s	α_c	GINGIVAL HEIGHT	α_s	α_c
	1,2 mm			2 mm			3 mm			4 mm			mm		
R	31.322.029.01-2	30°	23°	31.322.029.02-2	25°	15°	31.322.029.03-2	20	25	31.322.029.04-2	15°	25°	-	-	-
NR	31.312.029.01-2			31.312.029.02-2			31.312.029.03-2			31.312.029.04-2			-	-	-

DYNAMIC 3TIBASE®				
	GINGIVAL HEIGHT	α_s	α_s	α_s
	2 mm	CH=5mm	CH= 7mm	CH= 9mm
R	-	25°	20°	15°
NR	31.312.029.22-2			

DYNAMIC μ SCANBODY (LAB/CLIN)				DIGITAL ANALOG
SCANBODY	HEIGHT mm	ADAPTOR	SCREWDRIVER ADAPTOR	DIGITAL ANALOG
52.410.103.01-2	10	50.312.029.01-2	43.621.410.01-2	34.613.029.01-2
		50.312.029.03-2 (IG=3mm)	43.624.410.01-2	
52.412.103.01-2	12			

DYNAMIC MILLING TOOL			α_{di}
DYNAMIC MILLING TOOL	SHANK		
33.345.804.01-2	3	20°	
33.445.804.01-2	4		
33.645.804.01-2	6		

SCANALOG
23.412.029.01-2

DYNAMIC SCREWS			
DYNAMIC SCREW	HIGH DYNAMIC SCREW	DYNAMIC SCREWDRIVER	SCREWDRIVER LENGTH (mm)
41.316.094.01-2	41.316.132.01-2	43.618.201.01-2	18
		43.624.201.01-2	24
		43.632.201.01-2	32

STRAIGHT SCREWS	
STRAIGHT SCREW	SCREWDRIVER Hex. 1.20
40.316.003.02-2	43.601.103.02-2

ANALOG	LAB SCANBODY
-	30.412.001.01-2

MULTI-UNIT				
	GINGIVAL HEIGHT	GINGIVAL HEIGHT	GINGIVAL HEIGHT	GINGIVAL HEIGHT
	1 mm	2 mm	3 mm	4 mm
R	42.302.029.01-2	42.302.029.02-2	42.302.029.03-2	42.302.029.04-2

LIBRARY OPTIONS
GH = Gingival Height
CH = Cement Height
IG = Adaptor 3mm
 α_s = Standard maximum angulation
 α_c = Captive maximum angulation
 α_{di} = Direct to implant maximum angulation
 α_{dp} = Dynamic Premilled maximum angulation
R = Rotational / Non-Engaging
NR = Non Rotational / Engaging

STANDARD DYNAMIC TIBASE®															
	GINGIVAL HEIGHT	α_s	α_c	GINGIVAL HEIGHT	α_s	α_c	GINGIVAL HEIGHT	α_s	α_c	GINGIVAL HEIGHT	α_s	α_c	GINGIVAL HEIGHT	α_s	α_c
	1,1 mm			2 mm			3 mm			4 mm			mm		
R	31.323.030.01-2	42°	25°	31.323.030.02-2	25°	15°	31.323.030.03-2	20°	30°	31.323.030.04-2	15°	30°	-	-	-
NR	31.313.030.01-2			31.313.030.02-2			31.313.030.03-2			31.313.030.04-2			-	-	-

DYNAMIC 3TIBASE®							
	GINGIVAL HEIGHT	α_s	α_s	α_s	GINGIVAL HEIGHT	α_s	α_s
	1,1 mm	CH=5mm	CH= 7mm	CH= 9mm	3 mm	CH=5mm	CH= 7mm
R	31.323.030.21-2	25°	20°	10°	31.323.030.23-2	25°	20°
NR	31.313.030.21-2				31.313.030.23-2		

DYNAMIC μ SCANBODY (LAB/CLIN)				DIGITAL ANALOG
SCANBODY	HEIGHT mm	ADAPTOR	SCREWDRIVER ADAPTOR	DIGITAL ANALOG
52.408.101.01-2	8	50.313.030.01-2	43.621.410.01-2	34.613.030.01-2
52.410.101.01-2	10			
52.412.101.01-2	12			

DYNAMIC MILLING TOOL			α_{di}
DYNAMIC MILLING TOOL	SHANK		
33.345.808.01-2	3	30°	
33.445.808.01-2	4		
33.645.808.01-2	6		

SCANALOG
23.413.030.01-2

DYNAMIC SCREWS			
DYNAMIC SCREW	HIGH DYNAMIC SCREW	DYNAMIC SCREWDRIVER	SCREWDRIVER LENGTH (mm)
41.320.079.01-2	41.320.125.01-2	43.618.201.01-2	18
		43.624.201.01-2	24
		43.632.201.01-2	32

STRAIGHT SCREWS	
STRAIGHT SCREW	SCREWDRIVER Hex. 1.20
40.320.003.04-2	43.601.103.02-2

ANALOG	LAB SCANBODY
-	30.413.002.01-2

MULTI-UNIT					
	GINGIVAL HEIGHT	GINGIVAL HEIGHT	GINGIVAL HEIGHT	GINGIVAL HEIGHT	GINGIVAL HEIGHT
	1 mm	2 mm	3 mm	4 mm	5 mm
R	42.303.030.01-2	42.303.030.02-2	42.303.030.03-2	42.303.030.04-2	42.303.030.05-2

LIBRARY OPTIONS
GH = Gingival Height
CH = Cement Height
IG = Adaptor 3mm
 α_s = Standard maximum angulation
 α_c = Captive maximum angulation
 α_{di} = Direct to implant maximum angulation
 α_{dp} = Dynamic Premilled maximum angulation
R = Rotational / Non-Engaging
NR = Non Rotational / Engaging

STANDARD DYNAMIC TIBASE®															
	GINGIVAL HEIGHT	α_s	α_c	GINGIVAL HEIGHT	α_s	α_c	GINGIVAL HEIGHT	α_s	α_c	GINGIVAL HEIGHT	α_s	α_c	GINGIVAL HEIGHT	α_s	α_c
	1,3 mm			2 mm			3mm			4mm			mm		
R	31.322.033.01-2	38°	18°	31.322.033.02-2	20°	14°	31.322.033.03-2	15°	25°	31.322.033.04-2	15°	25°	-	-	-
NR	31.312.033.01-2			31.312.033.02-2			31.312.033.03-2			31.312.033.04-2			-	-	-

DYNAMIC 3TIBASE®								
	GINGIVAL HEIGHT	α_s	α_s	α_s	GINGIVAL HEIGHT	α_s	α_s	α_s
	1,3 mm	CH=5mm	CH= 7mm	CH= 9mm	3 mm	CH=5mm	CH= 7mm	CH= 9mm
R	31.322.033.21-2	25°	20°	10°	31.322.033.23-2	20°	15°	10°
NR	31.312.033.21-2				31.312.033.23-2			

DYNAMIC μ SCANBODY (LAB/CLIN)				DIGITAL ANALOG	DYNAMIC MILLING TOOL			SCANALOG
SCANBODY	HEIGHT mm	ADAPTOR	SCREWDRIVER ADAPTOR	DIGITAL ANALOG	DYNAMIC MILLING TOOL	SHANK	α_{di}	
52.408.106.01-2	8	50.312.033.01-2	43.621.410.01-2 43.624.410.01-2	34.612.033.01-2	33.315.804.01-2	3	25°	23.412.033.01-2
52.410.106.01-2	10				33.415.804.01-2	4		
52.412.106.01-2	12				50.312.033.03-2 (IG=3mm)	33.615.804.01-2		

DYNAMIC SCREWS				STRAIGHT SCREWS		ANALOG		LAB SCANBODY	
DYNAMIC SCREW	HIGH DYNAMIC SCREW	DYNAMIC SCREWDRIVER	SCREWDRIVER LENGTH (mm)	STRAIGHT SCREW	SCREWDRIVER TORX T6				
41.316.078.01-2	41.316.124.01-2	43.618.201.01-2	18	40.316.007.01-2	43.601.107.01-2	22.612.033.01-2	30.412.001.01-2		
		43.624.201.01-2	24						
		43.632.201.01-2	32						

MULTI-UNIT				
	GINGIVAL HEIGHT	GINGIVAL HEIGHT	GINGIVAL HEIGHT	GINGIVAL HEIGHT
	1 mm	2 mm	3 mm	4 mm
R	42.302.033.01-2	42.302.033.02-2	42.302.033.03-2	42.302.033.04-2

LIBRARY OPTIONS
GH = Gingival Height
CH = Cement Height
IG = Adaptor 3mm
 α_s = Standard maximum angulation
 α_c = Captive maximum angulation
 α_{di} = Direct to implant maximum angulation
 α_{dp} = Dynamic Premilled maximum angulation
R = Rotational / Non-Engaging
NR = Non Rotational / Engaging

STANDARD DYNAMIC TIBASE®															
	GINGIVAL HEIGHT	α_s	α_c	GINGIVAL HEIGHT	α_s	α_c	GINGIVAL HEIGHT	α_s	α_c	GINGIVAL HEIGHT	α_s	α_c	GINGIVAL HEIGHT	α_s	α_c
	1,1 mm			2 mm			3 mm			4 mm			mm		
R	31.323.035.01-2	39°	18°	31.323.035.02-2	20°	14°	31.323.035.03-2	15°	30°	31.323.035.04-2	15°	30°	-	-	-
NR	31.313.035.01-2			31.313.035.02-2			31.313.035.03-2			31.313.035.04-2			-	-	-

DYNAMIC 3TIBASE®								
	GINGIVAL HEIGHT	α_s	α_s	α_s	GINGIVAL HEIGHT	α_s	α_s	α_s
	1,1 mm	CH=5mm	CH= 7mm	CH= 9mm	3 mm	CH=5mm	CH= 7mm	CH= 9mm
R	31.323.035.21-2	25°	20°	10°	31.323.035.23-2	20°	15°	10°
NR	31.313.035.21-2				31.313.035.23-2			

DYNAMIC μ SCANBODY (LAB/CLIN)				DIGITAL ANALOG	DYNAMIC MILLING TOOL			SCANALOG
SCANBODY	HEIGHT mm	ADAPTOR	SCREWDRIVER ADAPTOR	DIGITAL ANALOG	DYNAMIC MILLING TOOL	SHANK	α_{di}	
52.410.107.01-2	10	50.313.035.01-2	43.621.410.01-2 43.624.410.01-2	34.613.035.01-2	33.315.804.01-2	3	25°	23.413.035.01-2
					33.415.804.01-2	4		
52.412.107.01-2	12				50.313.035.03-2 (IG=3mm)	33.615.804.01-2		

DYNAMIC SCREWS				STRAIGHT SCREWS		ANALOG		LAB SCANBODY	
DYNAMIC SCREW	HIGH DYNAMIC SCREW	DYNAMIC SCREWDRIVER	SCREWDRIVER LENGTH (mm)	STRAIGHT SCREW	SCREWDRIVER TORX T6				
41.316.078.01-2	41.316.124.01-2	43.618.201.01-2	18	40.316.007.01-2	43.601.107.01-2	22.613.035.01-2	30.413.002.01-2		
		43.624.201.01-2	24						
		43.632.201.01-2	32						

MULTI-UNIT				
	GINGIVAL HEIGHT	GINGIVAL HEIGHT	GINGIVAL HEIGHT	GINGIVAL HEIGHT
	1 mm	2 mm	3 mm	4 mm
R	42.303.035.01-2	42.303.035.02-2	42.303.035.03-2	42.303.035.04-2

LIBRARY OPTIONS
GH = Gingival Height
CH = Cement Height
IG = Adaptor 3mm
 α_s = Standard maximum angulation
 α_c = Captive maximum angulation
 α_{di} = Direct to implant maximum angulation
 α_{dp} = Dynamic Premilled maximum angulation
R = Rotational / Non-Engaging
NR = Non Rotational / Engaging

STANDARD DYNAMIC TIBASE®															
	GINGIVAL HEIGHT	α_s	α_c	GINGIVAL HEIGHT	α_s	α_c	GINGIVAL HEIGHT	α_s	α_c	GINGIVAL HEIGHT	α_s	α_c	GINGIVAL HEIGHT	α_s	α_c
	0,6 mm			mm			mm			mm			mm		
R	31.323.037.01-2	45°	25°	-	-	-	-	-	-	-	-	-	-	-	-
NR	31.313.037.01-2			-	-	-	-	-	-	-	-	-	-	-	-

DYNAMIC 3TIBASE®				
	GINGIVAL HEIGHT	α_s	α_s	α_s
		CH=5mm	CH=7mm	CH=9mm
R	-	-	-	-
NR	-	-	-	-

DYNAMIC μ SCANBODY (LAB/CLIN)				DIGITAL ANALOG
SCANBODY	HEIGHT mm	ADAPTOR	SCREWDRIVER ADAPTOR	DIGITAL ANALOG
52.408.110.01-2	8	50.313.037.04-2 (IG=3mm)	43.621.410.01-2 43.624.410.01-2	34.613.037.01-2
52.410.110.01-2	10			
52.412.110.01-2	12			

DYNAMIC MILLING TOOL		
DYNAMIC MILLING TOOL	SHANK	α_{di}
33.315.708.01-2	3	30°
33.415.708.01-2	4	
33.615.708.01-2	6	

SCANALOG
23.413.037.01-2

DYNAMIC SCREWS			
DYNAMIC SCREW	HIGH DYNAMIC SCREW	DYNAMIC SCREWDRIVER	SCREWDRIVER LENGTH (mm)
41.320.067.01-2	-	43.618.201.01-2	18
		43.624.201.01-2	24
		43.632.201.01-2	32

STRAIGHT SCREWS	
STRAIGHT SCREW	SCREWDRIVER TORX T6
40.320.007.01-2	43.601.107.01-2

ANALOG	LAB SCANBODY
22.613.037.01-2	30.413.004.01-2

LIBRARY OPTIONS

GH = Gingival Height
CH = Cement Height
IG = Adaptor 3mm

α_s = Standard maximum angulation
 α_c = Captive maximum angulation
 α_{di} = Direct to implant maximum angulation
 α_{dp} = Dynamic Premilled maximum angulation

R = Rotational / Non-Engaging
NR = Non Rotational / Engaging

STANDARD DYNAMIC TIBASE®															
	GINGIVAL HEIGHT	α_s	α_c	GINGIVAL HEIGHT	α_s	α_c	GINGIVAL HEIGHT	α_s	α_c	GINGIVAL HEIGHT	α_s	α_c	GINGIVAL HEIGHT	α_s	α_c
	0,7 mm			mm			mm			mm			mm		
R	31.322.038.01-2	45°	29°	-	-	-	-	-	-	-	-	-	-	-	-
NR	31.312.038.01-2			-	-	-	-	-	-	-	-	-	-	-	-

DYNAMIC 3TIBASE®				
	GINGIVAL HEIGHT	α_s	α_s	α_s
		CH=5mm	CH=7mm	CH=9mm
R	31.322.038.21-2	30°	25°	10°
NR	31.312.038.21-2			

DYNAMIC μ SCANBODY (LAB/CLIN)				DIGITAL ANALOG
SCANBODY	HEIGHT mm	ADAPTOR	SCREWDRIVER ADAPTOR	DIGITAL ANALOG
52.410.103.01-2	10	50.312.038.01-2	43.621.410.01-2 43.624.410.01-2	34.612.038.01-2
52.412.103.01-2	12			

DYNAMIC MILLING TOOL		
DYNAMIC MILLING TOOL	SHANK	α_{di}
33.345.804.01-2	3	25°
33.445.804.01-2	4	
33.645.804.01-2	6	

DYNAMIC SCREWS			
DYNAMIC SCREW	HIGH DYNAMIC SCREW	DYNAMIC SCREWDRIVER	SCREWDRIVER LENGTH (mm)
41.316.081.01-2	-	43.618.201.01-2	18
		43.624.201.01-2	24
		43.632.201.01-2	32

STRAIGHT SCREWS	
STRAIGHT SCREW	SCREWDRIVER Hex. 1.25
40.316.004.02-2	43.601.104.01-2

ANALOG	LAB SCANBODY
-	30.412.001.01-2

LIBRARY OPTIONS

GH = Gingival Height
CH = Cement Height
IG = Adaptor 3mm

α_s = Standard maximum angulation
 α_c = Captive maximum angulation
 α_{di} = Direct to implant maximum angulation
 α_{dp} = Dynamic Premilled maximum angulation

R = Rotational / Non-Engaging
NR = Non Rotational / Engaging

STANDARD DYNAMIC TIBASE®															
	GINGIVAL HEIGHT	α_s	α_c	GINGIVAL HEIGHT	α_s	α_c	GINGIVAL HEIGHT	α_s	α_c	GINGIVAL HEIGHT	α_s	α_c	GINGIVAL HEIGHT	α_s	α_c
	0,7 mm			mm			2 mm			mm			mm		
R	31.323.039.01-2	45°	29°	-	-	-	31.323.039.03-2	25°	-	-	-	-	-	-	-
NR	31.313.039.01-2			-	-	31.313.039.03-2	-			-	-	-	-		

DYNAMIC 3TIBASE®

	GINGIVAL HEIGHT	α_s	α_s	α_s
	0,7 mm	CH=5mm	CH= 7mm	CH= 9mm
R	31.323.039.21-2	30°	25°	10°
NR	31.313.039.21-2			

DYNAMIC μSCANBODY (LAB/CLIN) DIGITAL ANALOG

SCANBODY	HEIGHT mm	ADAPTOR	SCREWDRIVER ADAPTOR	DIGITAL ANALOG
52.410.114.01-2	10	50.313.039.01-2	43.621.410.01-2 43.624.410.01-2	34.613.039.01-2
52.412.114.01-2	12			

DYNAMIC MILLING TOOL

DYNAMIC MILLING TOOL	SHANK	α_{di}
33.345.856.01-2	3	25°
33.445.856.01-2	4	
33.645.856.01-2	6	

DYNAMIC SCREWS

DYNAMIC SCREW	HIGH DYNAMIC SCREW	DYNAMIC SCREWDRIVER	SCREWDRIVER LENGTH (mm)
41.316.081.01-2	-	43.618.201.01-2	18
		43.624.201.01-2	24
		43.632.201.01-2	32

STRAIGHT SCREWS

STRAIGHT SCREW	SCREWDRIVER Hex. 1.25
40.316.004.02-2	43.601.104.01-2

ANALOG	LAB SCANBODY
-	30.413.002.01-2

MULTI-UNIT

	GINGIVAL HEIGHT	GINGIVAL HEIGHT	GINGIVAL HEIGHT	GINGIVAL HEIGHT
	1 mm	2 mm	3 mm	4 mm
R	42.303.039.01-2	-	-	-

LIBRARY OPTIONS
GH = Gingival Height
CH = Cement Height
IG = Adaptor 3mm
 α_s = Standard maximum angulation
 α_c = Captive maximum angulation
 α_{di} = Direct to implant maximum angulation
 α_{dp} = Dynamic Premilled maximum angulation
R = Rotational / Non-Engaging
NR = Non Rotational / Engaging

STANDARD DYNAMIC TIBASE®															
	GINGIVAL HEIGHT	α_s	α_c	GINGIVAL HEIGHT	α_s	α_c	GINGIVAL HEIGHT	α_s	α_c	GINGIVAL HEIGHT	α_s	α_c	GINGIVAL HEIGHT	α_s	α_c
	0,6 mm			1,5 mm			3 mm			4 mm			5 mm		
R	31.322.040.01-2	45°	30°	31.322.040.02-2	25°	25°	31.322.040.03-2	20°	30°	31.322.040.04-2	15°	30°	31.322.040.05-2	10°	23°
NR	31.312.040.01-2			31.312.040.02-2			31.312.040.03-2			31.312.040.04-2			31.312.040.05-2		
NR (Friction-Fit)	31.312.042.01-2			-			-			-			-		

DYNAMIC 3TIBASE®

	GINGIVAL HEIGHT	α_s	α_s	α_s	GINGIVAL HEIGHT	α_s	α_s	α_s	GINGIVAL HEIGHT	α_s	α_s	α_s	GINGIVAL HEIGHT	α_s	α_s	α_s
	0,6 mm	CH= 5mm	CH= 7mm	CH= 9mm	1 mm	CH= 5mm	CH= 7mm	CH= 9mm	2 mm	CH= 5mm	CH= 7mm	CH= 9mm	3 mm	CH= 5mm	CH= 7mm	CH= 9mm
R	31.322.040.21-2	25°	20°	10°	31.322.040.29-2	30°	25°	20°		25°	20°	15°	31.322.040.23-2	25°	20°	15°
NR	31.312.040.21-2				31.312.040.29-2				31.312.040.28-2				31.312.040.23-2			

DYNAMIC μSCANBODY (LAB/CLIN) DIGITAL ANALOG DYNAMIC MILLING TOOL SCANALOG

SCANBODY	HEIGHT mm	ADAPTOR	SCREWDRIVER ADAPTOR	DIGITAL ANALOG	DYNAMIC MILLING TOOL	SHANK	α_{di}	SCANALOG
52.408.101.01-2	8	50.312.040.03-2 (IG=3mm)	43.621.410.01-2 43.624.410.01-2	34.612.040.01-2	33.370.716.01-2	3	25°	23.412.040.01-2
52.410.101.01-2	10				33.470.716.01-2	4		
52.412.101.01-2	12				33.670.716.01-2	6		

DYNAMIC SCREWS

DYNAMIC SCREW	HIGH DYNAMIC SCREW	DYNAMIC SCREWDRIVER	SCREWDRIVER LENGTH (mm)
41.317.071.01-2	41.317.106.01-2	43.618.201.01-2	18
		43.624.201.01-2	24
		43.632.201.01-2	32

STRAIGHT SCREWS

STRAIGHT SCREW	SCREWDRIVER Hex. 1.27
40.317.004.01-2	43.601.104.01-2

ANALOG	LAB SCANBODY
22.612.040.01-2	30.412.001.01-2

MULTI-UNIT

	GINGIVAL HEIGHT	GINGIVAL HEIGHT	GINGIVAL HEIGHT	GINGIVAL HEIGHT
	1 mm	2 mm	3 mm	4 mm
R	42.302.040.01-2	42.302.040.02-2	42.302.040.03-2	42.302.040.04-2

LIBRARY OPTIONS
GH = Gingival Height
CH = Cement Height
IG = Adaptor 3mm
 α_s = Standard maximum angulation
 α_c = Captive maximum angulation
 α_{di} = Direct to implant maximum angulation
 α_{dp} = Dynamic Premilled maximum angulation
R = Rotational / Non-Engaging
NR = Non Rotational / Engaging

COMPATIBLE with 0040b

STANDARD DYNAMIC TIBASE®																
	GINGIVAL HEIGHT		α_c	GINGIVAL HEIGHT		α_s	α_c	GINGIVAL HEIGHT		α_s	α_c	GINGIVAL HEIGHT		α_s	α_c	
	0,6 mm			1,5 mm				3 mm				5 mm				
R	31.322.040.01-2		45°	30°		25°	25°	31.322.040.03-2		20°	30°		31.322.040.05-2		10°	25°
NR	31.312.040.01-2				31.312.040.02-2			31.312.040.03-2					31.312.040.05-2			

DYNAMIC 3TIBASE®				
	GINGIVAL HEIGHT	α_s	α_s	α_s
	0,6 mm	CH=5mm	CH=7mm	CH=9mm
R	31.322.040.21-2			
NR	31.312.040.21-2	25°	20°	10°

DYNAMIC μSCANBODY (LAB/CLIN)				DIGITAL ANALOG
SCANBODY	HEIGHT mm	ADAPTOR	SCREWDRIVER ADAPTOR	DIGITAL ANALOG
-	-			
-	-			
-	-			

DYNAMIC MILLING TOOL		
DYNAMIC MILLING TOOL	SHANK	α_{di}
33.370.716.01-2	3	25°
33.470.716.01-2	4	
33.670.716.01-2	6	

DYNAMIC SCREWS			
DYNAMIC SCREW	HIGH DYNAMIC SCREW	DYNAMIC SCREWDRIVER	SCREWDRIVER LENGTH (mm)
41.318.071.01-2	-	43.618.201.01-2	18
		43.624.201.01-2	24
		43.632.201.01-2	32

STRAIGHT SCREWS	
STRAIGHT SCREW	SCREWDRIVER Hex. 1.27
-	-

ANALOG	LAB SCANBODY
-	30.412.001.01-2

MULTI-UNIT				
	GINGIVAL HEIGHT	GINGIVAL HEIGHT	GINGIVAL HEIGHT	GINGIVAL HEIGHT
	1 mm	2 mm	3 mm	4 mm
R	42.302.040.01-2	42.302.040.02-2	42.302.040.03-2	42.302.040.04-2

LIBRARY OPTIONS
GH = Gingival Height
CH = Cement Height
IG = Adaptor 3mm
 α_s = Standard maximum angulation
 α_c = Captive maximum angulation
 α_{di} = Direct to implant maximum angulation
 α_{dp} = Dynamic Premilled maximum angulation
R = Rotational / Non-Engaging
NR = Non Rotational / Engaging

COMPATIBLE with 0041

STANDARD DYNAMIC TIBASE®																
	GINGIVAL HEIGHT		α_s	α_c	GINGIVAL HEIGHT		α_s	α_c	GINGIVAL HEIGHT		α_s	α_c	GINGIVAL HEIGHT		α_s	α_c
	0,4 mm				1,5 mm				mm				mm			
R	31.323.041.01-2		45°	30°		30°	25°									
NR	31.313.041.01-2				31.313.041.02-2											
NR (Friction-Fit)	31.313.043.01-2				-											

DYNAMIC 3TIBASE®				
	GINGIVAL HEIGHT	α_s	α_s	α_s
	0,4 mm	CH=5mm	CH=7mm	CH=9mm
R	31.323.041.21-2			
NR	31.313.041.21-2	30°	20°	10°

DYNAMIC μSCANBODY (LAB/CLIN)				DIGITAL ANALOG
SCANBODY	HEIGHT mm	ADAPTOR	SCREWDRIVER ADAPTOR	DIGITAL ANALOG
52.410.102.01-2	10	50.313.041.03-2 (IG=3mm)	43.621.410.01-2	34.613.041.01-2
			43.624.410.01-2	
52.412.102.01-2	12			

DYNAMIC MILLING TOOL			SCANALOG
DYNAMIC MILLING TOOL	SHANK	α_{di}	
33.370.716.01-2	3	30°	23.413.041.01-2
33.470.716.01-2	4		
33.670.716.01-2	6		

DYNAMIC SCREWS			
DYNAMIC SCREW	HIGH DYNAMIC SCREW	DYNAMIC SCREWDRIVER	SCREWDRIVER LENGTH (mm)
41.317.071.01-2	-	43.618.201.01-2	18
		43.624.201.01-2	24
		43.632.201.01-2	32

STRAIGHT SCREWS	
STRAIGHT SCREW	SCREWDRIVER Hex. 1.27
40.317.004.01-2	43.601.104.01-2

ANALOG	LAB SCANBODY
22.613.041.01-2	30.413.002.01-2

LIBRARY OPTIONS
GH = Gingival Height
CH = Cement Height
IG = Adaptor 3mm
 α_s = Standard maximum angulation
 α_c = Captive maximum angulation
 α_{di} = Direct to implant maximum angulation
 α_{dp} = Dynamic Premilled maximum angulation
R = Rotational / Non-Engaging
NR = Non Rotational / Engaging

STANDARD DYNAMIC TIBASE®															
	GINGIVAL HEIGHT	α_s	α_c	GINGIVAL HEIGHT	α_s	α_c	GINGIVAL HEIGHT	α_s	α_c	GINGIVAL HEIGHT	α_s	α_c	GINGIVAL HEIGHT	α_s	α_c
	0,4 mm			1,5 mm			mm			mm			mm		
R	31.323.041.01-2	45°	30°	31.323.041.02-2	30°	25°	-	-	-	-	-	-	-	-	-
NR	31.313.041.01-2			31.313.041.02-2			-	-	-	-	-	-	-	-	-

DYNAMIC 3TIBASE®					
	GINGIVAL HEIGHT	α_s	α_s	α_s	
	0,4 mm	CH=5mm	CH= 7mm	CH= 9mm	
R	31.323.041.21-2	30°	20°	10°	
NR	31.313.041.21-2				

DYNAMIC μSCANBODY (LAB/CLIN)					DIGITAL ANALOG
SCANBODY	HEIGHT mm	ADAPTOR	SCREWDRIVER ADAPTOR	DIGITAL ANALOG	
-	-	-	-	-	
-	-	-	-	-	

DYNAMIC MILLING TOOL			
DYNAMIC MILLING TOOL	SHANK	α_{di}	
33.370.716.01-2	3	30°	
33.470.716.01-2	4		
33.670.716.01-2	6		

DYNAMIC SCREWS			
DYNAMIC SCREW	HIGH DYNAMIC SCREW	DYNAMIC SCREWDRIVER	SCREWDRIVER LENGTH (mm)
41.318.071.01-2	-	43.618.201.01-2	18
		43.624.201.01-2	24
		43.632.201.01-2	32

STRAIGHT SCREWS	
STRAIGHT SCREW	SCREWDRIVER Hex. 1.27
-	-

ANALOG	LAB SCANBODY
-	30.413.002.01-2

LIBRARY OPTIONS
GH = Gingival Height
CH = Cement Height
IG = Adaptor 3mm
 α_s = Standard maximum angulation
 α_c = Captive maximum angulation
 α_{di} = Direct to implant maximum angulation
 α_{dp} = Dynamic Premilled maximum angulation
R = Rotational / Non-Engaging
NR = Non Rotational / Engaging

STANDARD DYNAMIC TIBASE®															
	GINGIVAL HEIGHT	α_s	α_c	GINGIVAL HEIGHT	α_s	α_c	GINGIVAL HEIGHT	α_s	α_c	GINGIVAL HEIGHT	α_s	α_c	GINGIVAL HEIGHT	α_s	α_c
	1 mm			mm			mm			mm			mm		
R	31.322.044.01-2	42°	23°	-	-	-	-	-	-	-	-	-	-	-	-
NR	31.312.044.01-2			-	-	-	-	-	-	-	-	-	-	-	-

DYNAMIC 3TIBASE®				
	GINGIVAL HEIGHT	α_s	α_s	α_s
	1 mm	CH=5mm	CH= 7mm	CH= 9mm
R	31.322.044.21-2	25°	20°	10°
NR	31.312.044.21-2			

DYNAMIC μSCANBODY (LAB/CLIN)				DIGITAL ANALOG
SCANBODY	HEIGHT mm	ADAPTOR	SCREWDRIVER ADAPTOR	DIGITAL ANALOG
52.410.105.01-2	10	50.312.044.01-2	43.621.410.01-2 43.624.410.01-2	34.612.044.01-2
-	-			
52.412.105.01-2	12			

DYNAMIC MILLING TOOL		
DYNAMIC MILLING TOOL	SHANK	α_{di}
33.390.716.01-2	3	25°
33.490.716.01-2	4	
33.690.716.01-2	6	

DYNAMIC SCREWS			
DYNAMIC SCREW	HIGH DYNAMIC SCREW	DYNAMIC SCREWDRIVER	SCREWDRIVER LENGTH (mm)
41.318.065.01-2	-	43.618.201.01-2	18
		43.624.201.01-2	24
		43.632.201.01-2	32

STRAIGHT SCREWS	
STRAIGHT SCREW	SCREWDRIVER Hex. 1.20
40.318.003.01-2	43.601.103.02-2

ANALOG	LAB SCANBODY
-	30.412.001.01-2

LIBRARY OPTIONS
GH = Gingival Height
CH = Cement Height
IG = Adaptor 3mm
 α_s = Standard maximum angulation
 α_c = Captive maximum angulation
 α_{di} = Direct to implant maximum angulation
 α_{dp} = Dynamic Premilled maximum angulation
R = Rotational / Non-Engaging
NR = Non Rotational / Engaging

STANDARD DYNAMIC TIBASE®

	GINGIVAL HEIGHT 1 mm	α_s	α_c	GINGIVAL HEIGHT mm	α_s	α_c	GINGIVAL HEIGHT mm	α_s	α_c	GINGIVAL HEIGHT mm	α_s	α_c	GINGIVAL HEIGHT mm	α_s	α_c
R	31.323.045.01-2	43°	22°	-	-	-	-	-	-	-	-	-	-	-	-
NR	31.313.045.01-2			-	-	-	-	-	-	-	-	-	-	-	-

DYNAMIC 3TIBASE®

	GINGIVAL HEIGHT 1 mm	α_s CH=5mm	α_s CH= 7mm	α_s CH= 9mm
R	31.323.045.21-2	30°	20°	10°
NR	31.313.045.21-2			

DYNAMIC μSCANBODY (LAB/CLIN) DIGITAL ANALOG

SCANBODY	HEIGHT mm	ADAPTOR	SCREWDRIVER ADAPTOR	DIGITAL ANALOG
52.410.118.01-2	10	50.313.045.01-2	43.621.410.01-2 43.624.410.01-2	34.613.045.01-2
52.412.118.01-2	12			

DYNAMIC MILLING TOOL

DYNAMIC MILLING TOOL	SHANK	α_{di}
33.390.716.01-2	3	30°
33.490.716.01-2	4	
33.690.716.01-2	6	

DYNAMIC SCREWS

DYNAMIC SCREW	HIGH DYNAMIC SCREW	DYNAMIC SCREWDRIVER	SCREWDRIVER LENGTH (mm)
41.318.065.01-2	-	43.618.201.01-2	18
		43.624.201.01-2	24
		43.632.201.01-2	32

STRAIGHT SCREWS

STRAIGHT SCREW	SCREWDRIVER Hex. 1.20
40.318.003.01-2	43.601.103.02-2

ANALOG	LAB SCANBODY
-	30.413.002.01-2

LIBRARY OPTIONS
GH = Gingival Height
CH = Cement Height
IG = Adaptor 3mm
 α_s = Standard maximum angulation
 α_c = Captive maximum angulation
 α_{di} = Direct to implant maximum angulation
 α_{dp} = Dynamic Premilled maximum angulation
R = Rotational / Non-Engaging
NR = Non Rotational / Engaging

STANDARD DYNAMIC TIBASE®

	GINGIVAL HEIGHT 1 mm	α_s	α_c	GINGIVAL HEIGHT mm	α_s	α_c	GINGIVAL HEIGHT mm	α_s	α_c	GINGIVAL HEIGHT mm	α_s	α_c	GINGIVAL HEIGHT mm	α_s	α_c
R	31.324.046.01-2	42°	21°	-	-	-	-	-	-	-	-	-	-	-	-
NR	31.314.046.01-2			-	-	-	-	-	-	-	-	-	-	-	-

DYNAMIC 3TIBASE®

	GINGIVAL HEIGHT 1 mm	α_s CH=5mm	α_s CH= 7mm	α_s CH= 9mm
R	31.324.046.21-2	30°	20°	10°
NR	-			

DYNAMIC μSCANBODY (LAB/CLIN) DIGITAL ANALOG

SCANBODY	HEIGHT mm	ADAPTOR	SCREWDRIVER ADAPTOR	DIGITAL ANALOG
52.410.125.01-2	10	50.314.046.01-2	43.621.410.01-2 43.624.410.01-2	34.614.046.01-2
52.412.125.01-2	12			

DYNAMIC MILLING TOOL

DYNAMIC MILLING TOOL	SHANK	α_{di}
33.390.716.01-2	3	30°
33.490.716.01-2	4	
33.690.716.01-2	6	

DYNAMIC SCREWS

DYNAMIC SCREW	HIGH DYNAMIC SCREW	DYNAMIC SCREWDRIVER	SCREWDRIVER LENGTH (mm)
41.318.065.01-2	-	43.618.201.01-2	18
		43.624.201.01-2	24
		43.632.201.01-2	32

STRAIGHT SCREWS

STRAIGHT SCREW	SCREWDRIVER Hex. 1.20
40.318.003.01-2	43.601.103.02-2

ANALOG	LAB SCANBODY
-	30.413.002.01-2

LIBRARY OPTIONS
GH = Gingival Height
CH = Cement Height
IG = Adaptor 3mm
 α_s = Standard maximum angulation
 α_c = Captive maximum angulation
 α_{di} = Direct to implant maximum angulation
 α_{dp} = Dynamic Premilled maximum angulation
R = Rotational / Non-Engaging
NR = Non Rotational / Engaging

STANDARD DYNAMIC TIBASE®															
	GINGIVAL HEIGHT	α_s	α_c	GINGIVAL HEIGHT	α_s	α_c	GINGIVAL HEIGHT	α_s	α_c	GINGIVAL HEIGHT	α_s	α_c	GINGIVAL HEIGHT	α_s	α_c
	0,6 mm			mm			mm			mm			mm		
R	31.322.047.01-2	45°	30°	-	-	-	-	-	-	-	-	-	-	-	-
NR	31.312.047.01-2			-	-	-	-	-	-	-	-	-	-	-	-

DYNAMIC 3TIBASE®				
	GINGIVAL HEIGHT	α_s	α_s	α_s
	0,6 mm	CH=5mm	CH= 7mm	CH= 9mm
R	-	30°	25°	20°
NR	31.312.047.21-2			

DYNAMIC μ SCANBODY (LAB/CLIN)				DIGITAL ANALOG
SCANBODY	HEIGHT mm	ADAPTOR	SCREWDRIVER ADAPTOR	DIGITAL ANALOG
52.409.123.01-2	9	50.312.047.01-2	43.621.410.01-2 43.624.410.01-2	34.612.047.01-2
52.410.123.01-2	10			
52.412.123.01-2	12			

DYNAMIC MILLING TOOL		
DYNAMIC MILLING TOOL	SHANK	α_{di}
33.390.716.01-2	3	25°
33.490.716.01-2	4	
33.690.716.01-2	6	

DYNAMIC SCREWS			
DYNAMIC SCREW	HIGH DYNAMIC SCREW	DYNAMIC SCREWDRIVER	SCREWDRIVER LENGTH (mm)
41.320.074.01-2	-	43.618.201.01-2	18
		43.624.201.01-2	24
		43.632.201.01-2	32

STRAIGHT SCREWS	
STRAIGHT SCREW	SCREWDRIVER TORX T6
40.320.007.02-2	43.601.107.01-2

ANALOG	LAB SCANBODY
-	30.412.001.01-2

LIBRARY OPTIONS

GH = Gingival Height
CH = Cement Height
IG = Adaptor 3mm

α_s = Standard maximum angulation
 α_c = Captive maximum angulation
 α_{di} = Direct to implant maximum angulation
 α_{dp} = Dynamic Premilled maximum angulation

R = Rotational / Non-Engaging
NR = Non Rotational / Engaging

STANDARD DYNAMIC TIBASE®															
	GINGIVAL HEIGHT	α_s	α_c	GINGIVAL HEIGHT	α_s	α_c	GINGIVAL HEIGHT	α_s	α_c	GINGIVAL HEIGHT	α_s	α_c	GINGIVAL HEIGHT	α_s	α_c
	0,6 mm			mm			mm			mm			mm		
R	31.323.048.01-2	45°	30°	-	-	-	-	-	-	-	-	-	-	-	-
NR	31.313.048.01-2			-	-	-	-	-	-	-	-	-	-	-	-

DYNAMIC 3TIBASE®				
	GINGIVAL HEIGHT	α_s	α_s	α_s
	0,6 mm	CH=5mm	CH= 7mm	CH= 9mm
R	31.323.048.21-2	30°	25°	20°
NR	31.313.048.21-2			

DYNAMIC μ SCANBODY (LAB/CLIN)				DIGITAL ANALOG
SCANBODY	HEIGHT mm	ADAPTOR	SCREWDRIVER ADAPTOR	DIGITAL ANALOG
52.409.123.01-2	9	50.312.047.01-2	43.621.410.01-2 43.624.410.01-2	34.612.047.01-2
52.410.123.01-2	10			
52.412.123.01-2	12			

DYNAMIC MILLING TOOL		
DYNAMIC MILLING TOOL	SHANK	α_{di}
33.390.716.01-2	3	30°
33.490.716.01-2	4	
33.690.716.01-2	6	

DYNAMIC SCREWS			
DYNAMIC SCREW	HIGH DYNAMIC SCREW	DYNAMIC SCREWDRIVER	SCREWDRIVER LENGTH (mm)
41.320.074.01-2	-	43.618.201.01-2	18
		43.624.201.01-2	24
		43.632.201.01-2	32

STRAIGHT SCREWS	
STRAIGHT SCREW	SCREWDRIVER TORX T6
40.320.007.02-2	43.601.107.01-2

ANALOG	LAB SCANBODY
-	30.413.002.01-2

LIBRARY OPTIONS

GH = Gingival Height
CH = Cement Height
IG = Adaptor 3mm

α_s = Standard maximum angulation
 α_c = Captive maximum angulation
 α_{di} = Direct to implant maximum angulation
 α_{dp} = Dynamic Premilled maximum angulation

R = Rotational / Non-Engaging
NR = Non Rotational / Engaging

STANDARD DYNAMIC TIBASE®															
	GINGIVAL HEIGHT	α_s	α_c	GINGIVAL HEIGHT	α_s	α_c	GINGIVAL HEIGHT	α_s	α_c	GINGIVAL HEIGHT	α_s	α_c	GINGIVAL HEIGHT	α_s	α_c
	0,6 mm			mm			mm			mm			mm		
R	31.321.049.01-2	45°	30°	-	-	-	-	-	-	-	-	-	-	-	-
NR	31.311.049.01-2			-	-	-	-	-	-	-	-	-	-	-	-

DYNAMIC 3TIBASE®				
	GINGIVAL HEIGHT	α_s	α_s	α_s
		CH=5mm	CH= 7mm	CH= 9mm
R	-	-	-	-
NR	-	-	-	-

DYNAMIC μSCANBODY (LAB/CLIN)				DIGITAL ANALOG
SCANBODY	HEIGHT mm	ADAPTOR	SCREWDRIVER ADAPTOR	DIGITAL ANALOG
52.410.116.01-2	10	50.311.049.01-2	43.621.410.01-2	34.611.049.01-2
			43.624.410.01-2	
52.412.116.01-2	12			

DYNAMIC MILLING TOOL			
DYNAMIC MILLING TOOL	SHANK	α_{di}	
33.325.472.01-2*	3	25°	
33.425.472.01-2*	4		
33.625.472.01-2*	6		

* Only for titanium and soft materials

DYNAMIC SCREWS			
DYNAMIC SCREW	HIGH DYNAMIC SCREW	DYNAMIC SCREWDRIVER	SCREWDRIVER LENGTH (mm)
41.314.064.01-2	-	43.618.201.01-2	18
		43.624.201.01-2	24
		43.632.201.01-2	32

STRAIGHT SCREWS	
STRAIGHT SCREW	SCREWDRIVER Hex. 1.25
40.314.004.01-2	43.601.104.01-2

ANALOG	LAB SCANBODY
-	30.412.001.01-2

LIBRARY OPTIONS

GH = Gingival Height
CH = Cement Height
IG = Adaptor 3mm

α_s = Standard maximum angulation
 α_c = Captive maximum angulation
 α_{di} = Direct to implant maximum angulation
 α_{dp} = Dynamic Premilled maximum angulation

R = Rotational / Non-Engaging
NR = Non Rotational / Engaging

STANDARD DYNAMIC TIBASE®															
	GINGIVAL HEIGHT	α_s	α_c	GINGIVAL HEIGHT	α_s	α_c	GINGIVAL HEIGHT	α_s	α_c	GINGIVAL HEIGHT	α_s	α_c	GINGIVAL HEIGHT	α_s	α_c
	0,5 mm			mm			2 mm			mm			mm		
R	31.323.051.01-2	45°	27°	-	-	-	31.323.051.03-2	25°	-	-	-	-	-	-	-
NR	31.313.051.01-2			-	-	-	-			31.313.051.03-2	-	-	-	-	-

DYNAMIC 3TIBASE®				
	GINGIVAL HEIGHT	α_s	α_s	α_s
		CH=5mm	CH= 7mm	CH= 9mm
R	-	-	-	-
NR	-	-	-	-

DYNAMIC μSCANBODY (LAB/CLIN)				DIGITAL ANALOG
SCANBODY	HEIGHT mm	ADAPTOR	SCREWDRIVER ADAPTOR	DIGITAL ANALOG
52.410.117.01-2	10	50.312.050.01-2	43.621.410.01-2	34.612.050.01-2
		50.312.050.04-2 (IG=3mm)	43.624.410.01-2	
52.412.117.01-2	12			

DYNAMIC MILLING TOOL		
DYNAMIC MILLING TOOL	SHANK	α_{di}
33.335.676.01-2	3	25°
33.435.676.01-2	4	
33.635.676.01-2	6	

DYNAMIC SCREWS			
DYNAMIC SCREW	HIGH DYNAMIC SCREW	DYNAMIC SCREWDRIVER	SCREWDRIVER LENGTH (mm)
41.318.064.01-2	-	43.618.201.01-2	18
		43.624.201.01-2	24
		43.632.201.01-2	32

STRAIGHT SCREWS	
STRAIGHT SCREW	SCREWDRIVER Hex. 1.25
40.318.004.03-2	43.601.104.01-2

ANALOG	LAB SCANBODY
-	30.412.001.01-2

LIBRARY OPTIONS

GH = Gingival Height
CH = Cement Height
IG = Adaptor 3mm

α_s = Standard maximum angulation
 α_c = Captive maximum angulation
 α_{di} = Direct to implant maximum angulation
 α_{dp} = Dynamic Premilled maximum angulation

R = Rotational / Non-Engaging
NR = Non Rotational / Engaging

COMPATIBLE with 0051

STANDARD DYNAMIC TIBASE®															
	GINGIVAL HEIGHT	α_s	α_c	GINGIVAL HEIGHT	α_s	α_c	GINGIVAL HEIGHT	α_s	α_c	GINGIVAL HEIGHT	α_s	α_c	GINGIVAL HEIGHT	α_s	α_c
	0,5 mm			mm			2 mm			mm			mm		
R	31.323.051.01-2	45°	25°	-	-	-	31.323.051.03-2	25°	-	-	-	-	-	-	-
NR	31.313.051.01-2			-	-	31.313.051.03-2	-			-	-	-	-		

DYNAMIC 3TIBASE®				
	GINGIVAL HEIGHT	α_s	α_s	α_s
		CH=5mm	CH= 7mm	CH= 9mm
R	-	-	-	-
NR	-	-	-	-

DYNAMIC μ SCANBODY (LAB/CLIN)				DIGITAL ANALOG
SCANBODY	HEIGHT mm	ADAPTOR	SCREWDRIVER ADAPTOR	DIGITAL ANALOG
52.410.118.01-2	10	50.313.051.01-2	43.621.410.01-2	34.613.051.01-2
		50.313.051.04-2 (IG=3mm)	43.624.410.01-2	
52.412.118.01-2	12			

DYNAMIC MILLING TOOL			
DYNAMIC MILLING TOOL	SHANK	α_{di}	
33.335.676.01-2	3	25°	
33.435.676.01-2	4		
33.635.676.01-2	6		

DYNAMIC SCREWS			
DYNAMIC SCREW	HIGH DYNAMIC SCREW	DYNAMIC SCREWDRIVER	SCREWDRIVER LENGTH (mm)
41.318.064.01-2	-	43.618.201.01-2	18
		43.624.201.01-2	24
		43.632.201.01-2	32

STRAIGHT SCREWS	
STRAIGHT SCREW	SCREWDRIVER Hex. 1.25
40.318.004.03-2	43.601.104.01-2

ANALOG	LAB SCANBODY
-	30.412.001.01-2

LIBRARY OPTIONS

GH = Gingival Height
CH = Cement Height
IG = Adaptor 3mm

α_s = Standard maximum angulation
 α_c = Captive maximum angulation
 α_{di} = Direct to implant maximum angulation
 α_{dp} = Dynamic Premilled maximum angulation

R = Rotational / Non-Engaging
NR = Non Rotational / Engaging

COMPATIBLE with 0052

STANDARD DYNAMIC TIBASE®															
	GINGIVAL HEIGHT	α_s	α_c	GINGIVAL HEIGHT	α_s	α_c	GINGIVAL HEIGHT	α_s	α_c	GINGIVAL HEIGHT	α_s	α_c	GINGIVAL HEIGHT	α_s	α_c
	0,3 mm			mm			mm			mm			mm		
R	31.324.052.01-2	45°	27°	-	-	-	-	-	-	-	-	-	-	-	-
NR	31.314.052.01-2			-	-	-	-	-	-	-	-	-	-	-	-

DYNAMIC 3TIBASE®				
	GINGIVAL HEIGHT	α_s	α_s	α_s
		CH=5mm	CH= 7mm	CH= 9mm
R	-	-	-	-
NR	-	-	-	-

DYNAMIC μ SCANBODY (LAB/CLIN)				DIGITAL ANALOG
SCANBODY	HEIGHT mm	ADAPTOR	SCREWDRIVER ADAPTOR	DIGITAL ANALOG
52.410.102.01-2	10	50.314.052.01-2	43.621.410.01-2	34.614.052.01-2
			43.624.410.01-2	
52.412.102.01-2	12			

DYNAMIC MILLING TOOL		
DYNAMIC MILLING TOOL	SHANK	α_{di}
33.335.676.01-2	3	30°
33.435.676.01-2	4	
33.635.676.01-2	6	

DYNAMIC SCREWS			
DYNAMIC SCREW	HIGH DYNAMIC SCREW	DYNAMIC SCREWDRIVER	SCREWDRIVER LENGTH (mm)
41.318.064.01-2	-	43.618.201.01-2	18
		43.624.201.01-2	24
		43.632.201.01-2	32

STRAIGHT SCREWS	
STRAIGHT SCREW	SCREWDRIVER Hex. 1.25
40.318.004.03-2	43.601.104.01-2

ANALOG	LAB SCANBODY
-	30.413.002.01-2

LIBRARY OPTIONS

GH = Gingival Height
CH = Cement Height
IG = Adaptor 3mm

α_s = Standard maximum angulation
 α_c = Captive maximum angulation
 α_{di} = Direct to implant maximum angulation
 α_{dp} = Dynamic Premilled maximum angulation

R = Rotational / Non-Engaging
NR = Non Rotational / Engaging

STANDARD DYNAMIC TIBASE®															
	GINGIVAL HEIGHT	α_s	α_c	GINGIVAL HEIGHT	α_s	α_c	GINGIVAL HEIGHT	α_s	α_c	GINGIVAL HEIGHT	α_s	α_c	GINGIVAL HEIGHT	α_s	α_c
	0,6 mm			mm			mm			mm			mm		
R	31.323.054.01-2	45°	25°	-	-	-	-	-	-	-	-	-	-	-	-
NR	31.313.054.01-2			-	-	-	-	-	-	-	-	-	-	-	-

DYNAMIC 3TIBASE®				
	GINGIVAL HEIGHT	α_s	α_s	α_s
		CH=5mm	CH= 7mm	CH= 9mm
R	-	-	-	-
NR	-	-	-	-

DYNAMIC μSCANBODY (LAB/CLIN)				DIGITAL ANALOG
SCANBODY	HEIGHT mm	ADAPTOR	SCREWDRIVER ADAPTOR	DIGITAL ANALOG
52.410.119.01-2	10	50.314.054.01-2	43.621.410.01-2 43.624.410.01-2	34.614.054.01-2
52.412.119.01-2	12			

DYNAMIC MILLING TOOL		
DYNAMIC MILLING TOOL	SHANK	α_{di}
33.345.856.01-2	3	30°
33.445.856.01-2	4	
33.645.856.01-2	6	

DYNAMIC SCREWS			
DYNAMIC SCREW	HIGH DYNAMIC SCREW	DYNAMIC SCREWDRIVER	SCREWDRIVER LENGTH (mm)
41.318.067.01-2	-	43.618.201.01-2	18
		43.624.201.01-2	24
		43.632.201.01-2	32

STRAIGHT SCREWS	
STRAIGHT SCREW	SCREWDRIVER
40.318.012.01-2	-

ANALOG	LAB SCANBODY
-	30.413.002.01-2

LIBRARY OPTIONS
GH = Gingival Height
CH = Cement Height
IG = Adaptor 3mm
 α_s = Standard maximum angulation
 α_c = Captive maximum angulation
 α_{di} = Direct to implant maximum angulation
 α_{dp} = Dynamic Premilled maximum angulation
R = Rotational / Non-Engaging
NR = Non Rotational / Engaging

STANDARD DYNAMIC TIBASE®															
	GINGIVAL HEIGHT	α_s	α_c	GINGIVAL HEIGHT	α_s	α_c	GINGIVAL HEIGHT	α_s	α_c	GINGIVAL HEIGHT	α_s	α_c	GINGIVAL HEIGHT	α_s	α_c
	0,5 mm			mm			mm			mm			mm		
R	31.324.057.01-2	45°	27°	-	-	-	-	-	-	-	-	-	-	-	-
NR	31.314.057.01-2			-	-	-	-	-	-	-	-	-	-	-	-

DYNAMIC 3TIBASE®				
	GINGIVAL HEIGHT	α_s	α_s	α_s
		CH=5mm	CH= 7mm	CH= 9mm
R	-	-	-	-
NR	-	-	-	-

DYNAMIC μSCANBODY (LAB/CLIN)				DIGITAL ANALOG
SCANBODY	HEIGHT mm	ADAPTOR	SCREWDRIVER ADAPTOR	DIGITAL ANALOG
52.408.101.01-2	8	50.314.057.01-2	43.621.410.01-2 43.624.410.01-2	34.614.057.01-2
52.410.101.01-2	10			
52.412.101.01-2	12			

DYNAMIC MILLING TOOL		
DYNAMIC MILLING TOOL	SHANK	α_{di}
33.390.805.01-2	3	30°
33.490.805.01-2	4	
33.690.805.01-2	6	

DYNAMIC SCREWS			
DYNAMIC SCREW	HIGH DYNAMIC SCREW	DYNAMIC SCREWDRIVER	SCREWDRIVER LENGTH (mm)
41.316.084.01-2	-	43.618.201.01-2	18
		43.624.201.01-2	24
		43.632.201.01-2	32

STRAIGHT SCREWS	
STRAIGHT SCREW	SCREWDRIVER Hex. 1.20
40.316.003.01-2	43.601.103.02-2

ANALOG	LAB SCANBODY
22.614.057.01-2	30.414.003.01-2

LIBRARY OPTIONS
GH = Gingival Height
CH = Cement Height
IG = Adaptor 3mm
 α_s = Standard maximum angulation
 α_c = Captive maximum angulation
 α_{di} = Direct to implant maximum angulation
 α_{dp} = Dynamic Premilled maximum angulation
R = Rotational / Non-Engaging
NR = Non Rotational / Engaging

STANDARD DYNAMIC TIBASE®															
	GINGIVAL HEIGHT	α_s	α_c	GINGIVAL HEIGHT	α_s	α_c	GINGIVAL HEIGHT	α_s	α_c	GINGIVAL HEIGHT	α_s	α_c	GINGIVAL HEIGHT	α_s	α_c
	0,5 mm			mm			mm			mm			mm		
R	31.324.058.01-2	45°	30°	-	-	-	-	-	-	-	-	-	-	-	-
NR	31.314.058.01-2			-	-	-	-	-	-	-	-	-	-	-	-

DYNAMIC 3TIBASE®				
	GINGIVAL HEIGHT	α_s	α_s	α_s
		CH=5mm	CH= 7mm	CH= 9mm
R	-	-	-	-
NR	-	-	-	-

DYNAMIC μ SCANBODY (LAB/CLIN)				DIGITAL ANALOG
SCANBODY	HEIGHT mm	ADAPTOR	SCREWDRIVER ADAPTOR	DIGITAL ANALOG
52.410.118.01-2	10	50.314.058.01-2	43.621.410.01-2 43.624.410.01-2	34.614.058.01-2
52.412.118.01-2	12			

DYNAMIC MILLING TOOL		
DYNAMIC MILLING TOOL	SHANK	α_{di}
33.390.716.01-2	3	30°
33.490.716.01-2	4	
33.690.716.01-2	6	

DYNAMIC SCREWS			
DYNAMIC SCREW	HIGH DYNAMIC SCREW	DYNAMIC SCREWDRIVER	SCREWDRIVER LENGTH (mm)
41.320.047.01-2	-	43.618.201.01-2	18
		43.624.201.01-2	24
		43.632.201.01-2	32

STRAIGHT SCREWS	
STRAIGHT SCREW	SCREWDRIVER Hex. 1.20
40.320.003.01-2	43.601.103.02-2

ANALOG	LAB SCANBODY
22.614.058.01-2	30.414.003.01-2

LIBRARY OPTIONS

GH = Gingival Height
CH = Cement Height
IG = Adaptor 3mm

α_s = Standard maximum angulation
 α_c = Captive maximum angulation
 α_{di} = Direct to implant maximum angulation
 α_{dp} = Dynamic Premilled maximum angulation

R = Rotational / Non-Engaging
NR = Non Rotational / Engaging

STANDARD DYNAMIC TIBASE®															
	GINGIVAL HEIGHT	α_s	α_c	GINGIVAL HEIGHT	α_s	α_c	GINGIVAL HEIGHT	α_s	α_c	GINGIVAL HEIGHT	α_s	α_c	GINGIVAL HEIGHT	α_s	α_c
	0,7 mm			mm			mm			mm			mm		
R	31.324.059.01-2	45°	27°	-	-	-	-	-	-	-	-	-	-	-	-
NR	31.314.059.01-2			-	-	-	-	-	-	-	-	-	-	-	-

DYNAMIC 3TIBASE®				
	GINGIVAL HEIGHT	α_s	α_s	α_s
		CH=5mm	CH= 7mm	CH= 9mm
R	-	-	-	-
NR	-	-	-	-

DYNAMIC μ SCANBODY (LAB/CLIN)				DIGITAL ANALOG
SCANBODY	HEIGHT mm	ADAPTOR	SCREWDRIVER ADAPTOR	DIGITAL ANALOG
52.410.115.01-2	10	50.313.010.01-2	43.621.410.01-2 43.624.410.01-2	-
52.412.115.01-2	12	50.313.010.04-2 (IG=3mm)		

DYNAMIC MILLING TOOL		
DYNAMIC MILLING TOOL	SHANK	α_{di}
33.390.716.01-2	3	25
33.490.716.01-2	4	
33.690.716.01-2	6	

DYNAMIC SCREWS			
DYNAMIC SCREW	HIGH DYNAMIC SCREW	DYNAMIC SCREWDRIVER	SCREWDRIVER LENGTH (mm)
41.318.065.01-2	-	43.618.201.01-2	18
		43.624.201.01-2	24
		43.632.201.01-2	32

STRAIGHT SCREWS	
STRAIGHT SCREW	SCREWDRIVER Hex. 1.20
40.318.003.01-2	43.601.103.02-2

ANALOG	LAB SCANBODY
-	30.414.003.01-2

LIBRARY OPTIONS

GH = Gingival Height
CH = Cement Height
IG = Adaptor 3mm

α_s = Standard maximum angulation
 α_c = Captive maximum angulation
 α_{di} = Direct to implant maximum angulation
 α_{dp} = Dynamic Premilled maximum angulation

R = Rotational / Non-Engaging
NR = Non Rotational / Engaging

STANDARD DYNAMIC TIBASE®															
	GINGIVAL HEIGHT	α_s	α_c	GINGIVAL HEIGHT	α_s	α_c	GINGIVAL HEIGHT	α_s	α_c	GINGIVAL HEIGHT	α_s	α_c	GINGIVAL HEIGHT	α_s	α_c
	0,5 mm			mm			mm			mm			mm		
R	31.324.060.01-2	45°	30°	-	-	-	-	-	-	-	-	-	-	-	-
NR	31.314.060.01-2			-	-	-	-	-	-	-	-	-	-	-	-

DYNAMIC 3TIBASE®				
	GINGIVAL HEIGHT	α_s	α_c	α_s
		CH=5mm	CH= 7mm	CH= 9mm
R	-	-	-	-
NR	-	-	-	-

DYNAMIC μ SCANBODY (LAB/CLIN)				DIGITAL ANALOG
SCANBODY	HEIGHT mm	ADAPTOR	SCREWDRIVER ADAPTOR	DIGITAL ANALOG
52.410.122.01-2	10	50.314.060.01-2	43.621.410.01-2	34.614.060.01-2
			43.624.410.01-2	
-	-			

DYNAMIC MILLING TOOL		
DYNAMIC MILLING TOOL	SHANK	α_{di}
33.390.716.01-2	3	30°
33.490.716.01-2	4	
33.690.716.01-2	6	

DYNAMIC SCREWS			
DYNAMIC SCREW	HIGH DYNAMIC SCREW	DYNAMIC SCREWDRIVER	SCREWDRIVER LENGTH (mm)
41.320.060.01-2	-	43.618.201.01-2	18
		43.624.201.01-2	24
		43.632.201.01-2	32

STRAIGHT SCREWS	
STRAIGHT SCREW	SCREWDRIVER Hex. 1.20
40.320.003.02-2	43.601.103.02-2

ANALOG	LAB SCANBODY
22.614.060.01-2	30.415.007.01-2

LIBRARY OPTIONS

GH = Gingival Height
CH = Cement Height
IG = Adaptor 3mm

α_s = Standard maximum angulation
 α_c = Captive maximum angulation
 α_{di} = Direct to implant maximum angulation
 α_{dp} = Dynamic Premilled maximum angulation

R = Rotational / Non-Engaging
NR = Non Rotational / Engaging

STANDARD DYNAMIC TIBASE®															
	GINGIVAL HEIGHT	α_s	α_c	GINGIVAL HEIGHT	α_s	α_c	GINGIVAL HEIGHT	α_s	α_c	GINGIVAL HEIGHT	α_s	α_c	GINGIVAL HEIGHT	α_s	α_c
	0,6 mm			mm			mm			mm			mm		
R	31.324.061.01-2	45°	30°	-	-	-	-	-	-	-	-	-	-	-	-
NR	31.314.061.01-2			-	-	-	-	-	-	-	-	-	-	-	-

DYNAMIC 3TIBASE®				
	GINGIVAL HEIGHT	α_s	α_c	α_s
		CH=5mm	CH= 7mm	CH= 9mm
R	-	-	-	-
NR	-	-	-	-

DYNAMIC μ SCANBODY (LAB/CLIN)				DIGITAL ANALOG
SCANBODY	HEIGHT mm	ADAPTOR	SCREWDRIVER ADAPTOR	DIGITAL ANALOG
52.410.125.01-2	10	50.314.061.01-2	43.621.410.01-2	34.614.061.01-2
			43.624.410.01-2	
-	-			

DYNAMIC MILLING TOOL		
DYNAMIC MILLING TOOL	SHANK	α_{di}
33.390.958.01-2	3	30°
33.490.958.01-2	4	
33.690.958.01-2	6	

DYNAMIC SCREWS			
DYNAMIC SCREW	HIGH DYNAMIC SCREW	DYNAMIC SCREWDRIVER	SCREWDRIVER LENGTH (mm)
41.325.067.01-2	-	43.618.201.01-2	18
		43.624.201.01-2	24
		43.632.201.01-2	32

STRAIGHT SCREWS	
STRAIGHT SCREW	SCREWDRIVER UNIGRIP
40.325.008.01-2	43.601.108.01-2

ANALOG	LAB SCANBODY
22.614.061.01-2	30.415.007.01-2

LIBRARY OPTIONS

GH = Gingival Height
CH = Cement Height
IG = Adaptor 3mm

α_s = Standard maximum angulation
 α_c = Captive maximum angulation
 α_{di} = Direct to implant maximum angulation
 α_{dp} = Dynamic Premilled maximum angulation

R = Rotational / Non-Engaging
NR = Non Rotational / Engaging

COMPATIBLE with 0066

STANDARD DYNAMIC TIBASE®															
	GINGIVAL HEIGHT	α_s	α_c	GINGIVAL HEIGHT	α_s	α_c	GINGIVAL HEIGHT	α_s	α_c	GINGIVAL HEIGHT	α_s	α_c	GINGIVAL HEIGHT	α_s	α_c
	0,6 mm			mm			mm			mm			mm		
R	31.323.066.01-2	45°	30°	-	-	-	-	-	-	-	-	-	-	-	-
NR	-			-	-	-	-	-	-	-	-	-	-	-	-

DYNAMIC 3TIBASE®				
	GINGIVAL HEIGHT	α_s	α_s	α_s
		CH=5mm	CH= 7mm	CH= 9mm
R	-	-	-	-
NR	-	-	-	-

DYNAMIC μ SCANBODY (LAB/CLIN)				DIGITAL ANALOG
SCANBODY	HEIGHT mm	ADAPTOR	SCREWDRIVER ADAPTOR	DIGITAL ANALOG
-	-	-	-	-
-	-	-	-	-

DYNAMIC MILLING TOOL		
DYNAMIC MILLING TOOL	SHANK	α_{di}
-	-	-
-	-	-
-	-	-

DYNAMIC SCREWS			
DYNAMIC SCREW	HIGH DYNAMIC SCREW	DYNAMIC SCREWDRIVER	SCREWDRIVER LENGTH (mm)
41.314.039.01-2	-	43.618.201.01-2	18
		43.624.201.01-2	24
		43.632.201.01-2	32

STRAIGHT SCREWS	
STRAIGHT SCREW	SCREWDRIVER Unigrip
40.314.008.01-2	43.601.108.01-2

ANALOG	LAB SCANBODY
-	30.412.001.01-2

LIBRARY OPTIONS
GH = Gingival Height
CH = Cement Height
IG = Adaptor 3mm

COMPATIBLE with 0074

STANDARD DYNAMIC TIBASE®															
	GINGIVAL HEIGHT	α_s	α_c	GINGIVAL HEIGHT	α_s	α_c	GINGIVAL HEIGHT	α_s	α_c	GINGIVAL HEIGHT	α_s	α_c	GINGIVAL HEIGHT	α_s	α_c
	0,6 mm			mm			mm			mm			mm		
R	31.323.074.01-2	45°	30°	-	-	-	-	-	-	-	-	-	-	-	-
NR	31.313.074.01-2			-	-	-	-	-	-	-	-	-	-	-	-

DYNAMIC 3TIBASE®				
	GINGIVAL HEIGHT	α_s	α_s	α_s
		CH=5mm	CH= 7mm	CH= 9mm
R	-	-	-	-
NR	-	-	-	-

DYNAMIC μ SCANBODY (LAB/CLIN)				DIGITAL ANALOG
SCANBODY	HEIGHT mm	ADAPTOR	SCREWDRIVER ADAPTOR	DIGITAL ANALOG
52.408.110.01-2	8	50.313.074.01-2	43.621.410.01-2	34.613.074.01-2
52.410.110.01-2	10		43.624.410.01-2	
52.412.110.01-2	12			

DYNAMIC MILLING TOOL			SCANALOG
DYNAMIC MILLING TOOL	SHANK	α_{di}	
33.330.708.01-2	3	30°	23.413.074.01-2
33.430.708.01-2	4		
33.630.708.01-2	6		

DYNAMIC SCREWS			
DYNAMIC SCREW	HIGH DYNAMIC SCREW	DYNAMIC SCREWDRIVER	SCREWDRIVER LENGTH (mm)
41.320.050.01-2	-	43.618.201.01-2	18
		43.624.201.01-2	24
		43.632.201.01-2	32

STRAIGHT SCREWS	
STRAIGHT SCREW	SCREWDRIVER Sq. 1.30
40.320.007.04-2	43.601.102.01-2

ANALOG	LAB SCANBODY
22.613.074.01-2	30.415.007.01-2

LIBRARY OPTIONS
GH = Gingival Height
CH = Cement Height
IG = Adaptor 3mm
 α_s = Standard maximum angulation
 α_c = Captive maximum angulation
 α_{di} = Direct to implant maximum angulation
 α_{dp} = Dynamic Premilled maximum angulation

R = Rotational / Non-Engaging
NR = Non Rotational / Engaging

COMPATIBLE with 0075

STANDARD DYNAMIC TIBASE®															
	GINGIVAL HEIGHT	α_s	α_c	GINGIVAL HEIGHT	α_s	α_c	GINGIVAL HEIGHT	α_s	α_c	GINGIVAL HEIGHT	α_s	α_c	GINGIVAL HEIGHT	α_s	α_c
	1 mm			2 mm			3 mm			4 mm			mm		
R	31.322.075.01-2	42°	24°	31.322.075.02-2	25°	15°	31.322.075.03-2	20°	-	31.322.075.04-2	15°	-	-	-	-
NR	-			31.312.075.02-2			31.312.075.03-2			31.312.075.04-2			-	-	-

DYNAMIC 3TIBASE®				
	GINGIVAL HEIGHT	α_s	α_c	α_s
	1 mm	CH=5mm	CH=7mm	CH=9mm
R	31.322.075.21-2	30°	20°	15°
NR	-			

DYNAMIC μ SCANBODY (LAB/CLIN)				DIGITAL ANALOG
SCANBODY	HEIGHT mm	ADAPTOR	SCREWDRIVER ADAPTOR	DIGITAL ANALOG
52.410.105.01-2	10	50.312.075.03-2 (IG=3mm)	43.621.410.01-2	34.612.075.01-2
			43.624.410.01-2	
52.412.105.01-2	12			

DYNAMIC MILLING TOOL		
DYNAMIC MILLING TOOL	SHANK	α_{di}
33.330.734.01-2	3	25°
33.430.734.01-2	4	
33.630.734.01-2	6	

DYNAMIC SCREWS			
DYNAMIC SCREW	HIGH DYNAMIC SCREW	DYNAMIC SCREWDRIVER	SCREWDRIVER LENGTH (mm)
41.318.077.01-2	-	43.618.201.01-2	18
		43.624.201.01-2	24
		43.632.201.01-2	32

STRAIGHT SCREWS	
STRAIGHT SCREW	SCREWDRIVER Hex. 1.00
40.318.013.01-2	-

ANALOG	LAB SCANBODY
22.612.075.01-2	30.412.001.01-2

MULTI-UNIT				
	GINGIVAL HEIGHT	GINGIVAL HEIGHT	GINGIVAL HEIGHT	GINGIVAL HEIGHT
	1 mm	2 mm	3 mm	4 mm
R	-	42.302.075.02-2	42.302.075.03-2	42.302.075.04-2

LIBRARY OPTIONS

GH = Gingival Height
CH = Cement Height
IG = Adaptor 3mm

α_s = Standard maximum angulation
 α_c = Captive maximum angulation
 α_{di} = Direct to implant maximum angulation
 α_{dp} = Dynamic Premilled maximum angulation

R = Rotational / Non-Engaging
NR = Non Rotational / Engaging

COMPATIBLE with 0080

STANDARD DYNAMIC TIBASE®															
	GINGIVAL HEIGHT	α_s	α_c	GINGIVAL HEIGHT	α_s	α_c	GINGIVAL HEIGHT	α_s	α_c	GINGIVAL HEIGHT	α_s	α_c	GINGIVAL HEIGHT	α_s	α_c
	0,4 mm			mm			mm			mm			mm		
R	31.324.080.01-2	45°	30°	-	-	-	-	-	-	-	-	-	-	-	-
NR	31.314.080.01-2			-			-			-			-		-

DYNAMIC 3TIBASE®				
	GINGIVAL HEIGHT	α_s	α_c	α_s
		CH=5mm	CH=7mm	CH=9mm
R	-	-	-	-
NR	-			

DYNAMIC μ SCANBODY (LAB/CLIN)				DIGITAL ANALOG
SCANBODY	HEIGHT mm	ADAPTOR	SCREWDRIVER ADAPTOR	DIGITAL ANALOG
52.410.124.01-2	10	50.314.080.01-2	43.621.410.01-2	34.614.080.01-2
			43.624.410.01-2	
52.412.124.01-2	12			

DYNAMIC MILLING TOOL		
DYNAMIC MILLING TOOL	SHANK	α_{di}
33.370.716.01-2	3	30°
33.470.716.01-2	4	
33.670.716.01-2	6	

DYNAMIC SCREWS			
DYNAMIC SCREW	HIGH DYNAMIC SCREW	DYNAMIC SCREWDRIVER	SCREWDRIVER LENGTH (mm)
41.317.071.01-2	-	43.618.201.01-2	18
		43.624.201.01-2	24
		43.632.201.01-2	32

STRAIGHT SCREWS	
STRAIGHT SCREW	SCREWDRIVER Hex. 1.27
40.317.004.01-2	43.601.104.01-2

ANALOG	LAB SCANBODY
-	30.414.003.01-2

LIBRARY OPTIONS

GH = Gingival Height
CH = Cement Height
IG = Adaptor 3mm

α_s = Standard maximum angulation
 α_c = Captive maximum angulation
 α_{di} = Direct to implant maximum angulation
 α_{dp} = Dynamic Premilled maximum angulation

R = Rotational / Non-Engaging
NR = Non Rotational / Engaging

STANDARD DYNAMIC TIBASE®															
	GINGIVAL HEIGHT	α_s	α_c	GINGIVAL HEIGHT	α_s	α_c	GINGIVAL HEIGHT	α_s	α_c	GINGIVAL HEIGHT	α_s	α_c	GINGIVAL HEIGHT	α_s	α_c
	0,4 mm			mm			mm			mm			mm		
R	31.325.081.01-2	41°	18°	-	-	-	-	-	-	-	-	-	-	-	-
NR	31.315.081.01-2			-	-	-	-	-	-	-	-	-	-	-	-

DYNAMIC 3TIBASE®				
	GINGIVAL HEIGHT	α_s	α_s	α_s
		CH=5mm	CH= 7mm	CH= 9mm
R	-	-	-	-
NR	-	-	-	-

DYNAMIC μ SCANBODY (LAB/CLIN)				DIGITAL ANALOG
SCANBODY	HEIGHT mm	ADAPTOR	SCREWDRIVER ADAPTOR	DIGITAL ANALOG
52.410.126.01-2	10	50.315.081.01-2	43.621.410.01-2	34.615.081.01-2
			43.624.410.01-2	
52.412.126.01-2	12			

DYNAMIC MILLING TOOL		
DYNAMIC MILLING TOOL	SHANK	α_{di}
33.335.676.01-2	3	30°
33.435.676.01-2	4	
33.635.676.01-2	6	

DYNAMIC SCREWS			
DYNAMIC SCREW	HIGH DYNAMIC SCREW	DYNAMIC SCREWDRIVER	SCREWDRIVER LENGTH (mm)
41.318.064.01-2	-	43.618.201.01-2	18
		43.624.201.01-2	24
		43.632.201.01-2	32

STRAIGHT SCREWS	
STRAIGHT SCREW	SCREWDRIVER Hex. 1.25
40.318.004.03-2	43.601.104.01-2

ANALOG	LAB SCANBODY
-	30.414.003.01-2

LIBRARY OPTIONS

GH = Gingival Height
CH = Cement Height
IG = Adaptor 3mm

α_s = Standard maximum angulation
 α_c = Captive maximum angulation
 α_{di} = Direct to implant maximum angulation
 α_{dp} = Dynamic Premilled maximum angulation

R = Rotational / Non-Engaging
NR = Non Rotational / Engaging

STANDARD DYNAMIC TIBASE®															
	GINGIVAL HEIGHT	α_s	α_c	GINGIVAL HEIGHT	α_s	α_c	GINGIVAL HEIGHT	α_s	α_c	GINGIVAL HEIGHT	α_s	α_c	GINGIVAL HEIGHT	α_s	α_c
	1,2 mm			mm			mm			mm			mm		
R	31.322.082.01-2	45°	25°	-	-	-	-	-	-	-	-	-	-	-	-
NR	31.312.082.01-2			-	-	-	-	-	-	-	-	-	-	-	-

DYNAMIC 3TIBASE®				
	GINGIVAL HEIGHT	α_s	α_s	α_s
		CH=5mm	CH= 7mm	CH= 9mm
R	-	-	-	-
NR	-	-	-	-

DYNAMIC μ SCANBODY (LAB/CLIN)				DIGITAL ANALOG
SCANBODY	HEIGHT mm	ADAPTOR	SCREWDRIVER ADAPTOR	DIGITAL ANALOG
52.410.105.01-2	10	50.312.082.01-2	43.621.410.01-2	34.612.082.01-2
			43.624.410.01-2	
52.412.105.01-2	12			

DYNAMIC MILLING TOOL		
DYNAMIC MILLING TOOL	SHANK	α_{di}
33.345.804.01-2	3	25°
33.445.804.01-2	4	
33.645.804.01-2	6	

DYNAMIC SCREWS			
DYNAMIC SCREW	HIGH DYNAMIC SCREW	DYNAMIC SCREWDRIVER	SCREWDRIVER LENGTH (mm)
41.316.074.01-2	-	43.618.201.01-2	18
		43.624.201.01-2	24
		43.632.201.01-2	32

STRAIGHT SCREWS	
STRAIGHT SCREW	SCREWDRIVER
40.316.012.01-2	-

ANALOG	LAB SCANBODY
-	30.412.001.01-2

LIBRARY OPTIONS

GH = Gingival Height
CH = Cement Height
IG = Adaptor 3mm

α_s = Standard maximum angulation
 α_c = Captive maximum angulation
 α_{di} = Direct to implant maximum angulation
 α_{dp} = Dynamic Premilled maximum angulation

R = Rotational / Non-Engaging
NR = Non Rotational / Engaging

STANDARD DYNAMIC TIBASE®															
	GINGIVAL HEIGHT	α_s	α_c	GINGIVAL HEIGHT	α_s	α_c	GINGIVAL HEIGHT	α_s	α_c	GINGIVAL HEIGHT	α_s	α_c	GINGIVAL HEIGHT	α_s	α_c
	1,2 mm			mm			mm			mm			mm		
R	31.323.083.01-2	45°	25°	-	-	-	-	-	-	-	-	-	-	-	-
NR	31.313.083.01-2			-	-	-	-	-	-	-	-	-	-	-	-

DYNAMIC 3TIBASE®				
	GINGIVAL HEIGHT	α_s	α_c	α_{di}
		CH=5mm	CH= 7mm	CH= 9mm
R	-	-	-	-
NR	-	-	-	-

DYNAMIC μ SCANBODY (LAB/CLIN)				DIGITAL ANALOG
SCANBODY	HEIGHT mm	ADAPTOR	SCREWDRIVER ADAPTOR	DIGITAL ANALOG
52.410.103.01-2	10	50.313.083.01-2	43.621.410.01-2	34.613.083.01-2
			43.624.410.01-2	
52.412.103.01-2	12			

DYNAMIC MILLING TOOL		
DYNAMIC MILLING TOOL	SHANK	α_{di}
33.345.856.01-2	3	30°
33.445.856.01-2	4	
33.645.856.01-2	6	

DYNAMIC SCREWS			
DYNAMIC SCREW	HIGH DYNAMIC SCREW	DYNAMIC SCREWDRIVER	SCREWDRIVER LENGTH (mm)
41.318.076.01-2	-	43.618.201.01-2	18
		43.624.201.01-2	24
		43.632.201.01-2	32

STRAIGHT SCREWS	
STRAIGHT SCREW	SCREWDRIVER
40.318.012.02-2	-

ANALOG	LAB SCANBODY
-	30.413.002.01-2

LIBRARY OPTIONS

GH = Gingival Height
CH = Cement Height
IG = Adaptor 3mm

α_s = Standard maximum angulation
 α_c = Captive maximum angulation
 α_{di} = Direct to implant maximum angulation
 α_{dp} = Dynamic Premilled maximum angulation

R = Rotational / Non-Engaging
NR = Non Rotational / Engaging

STANDARD DYNAMIC TIBASE®															
	GINGIVAL HEIGHT	α_s	α_c	GINGIVAL HEIGHT	α_s	α_c	GINGIVAL HEIGHT	α_s	α_c	GINGIVAL HEIGHT	α_s	α_c	GINGIVAL HEIGHT	α_s	α_c
	1 mm			mm			mm			mm			mm		
R	31.321.084.01-2	40°	-	-	-	-	-	-	-	-	-	-	-	-	-
NR	31.311.084.01-2			-	-	-	-	-	-	-	-	-	-	-	-

DYNAMIC 3TIBASE®				
	GINGIVAL HEIGHT	α_s	α_c	α_{di}
		CH=5mm	CH= 7mm	CH= 9mm
R	-	-	-	-
NR	-	-	-	-

DYNAMIC μ SCANBODY (LAB/CLIN)				DIGITAL ANALOG
SCANBODY	HEIGHT mm	ADAPTOR	SCREWDRIVER ADAPTOR	DIGITAL ANALOG
-	-	-	-	-
-	-			

DYNAMIC MILLING TOOL		
DYNAMIC MILLING TOOL	SHANK	α_{di}
-	-	-
-	-	
-	-	

DYNAMIC SCREWS			
DYNAMIC SCREW	HIGH DYNAMIC SCREW	DYNAMIC SCREWDRIVER	SCREWDRIVER LENGTH (mm)
41.314.076.01-2	-	43.618.201.01-2	18
		43.624.201.01-2	24
		43.632.201.01-2	32

STRAIGHT SCREWS	
STRAIGHT SCREW	SCREWDRIVER Star 1.50
40.314.003.03-2	43.601.103.02-2

ANALOG	LAB SCANBODY
-	30.410.006.01-2

LIBRARY OPTIONS

GH = Gingival Height
CH = Cement Height
IG = Adaptor 3mm

α_s = Standard maximum angulation
 α_c = Captive maximum angulation
 α_{di} = Direct to implant maximum angulation
 α_{dp} = Dynamic Premilled maximum angulation

R = Rotational / Non-Engaging
NR = Non Rotational / Engaging

STANDARD DYNAMIC TIBASE®

	GINGIVAL HEIGHT	α_s	α_c	GINGIVAL HEIGHT	α_s	α_c	GINGIVAL HEIGHT	α_s	α_c	GINGIVAL HEIGHT	α_s	α_c	GINGIVAL HEIGHT	α_s	α_c
	0,3 mm			mm			mm			mm			mm		
R	31.324.085.01-2	45°	30°	-	-	-	-	-	-	-	-	-	-	-	-
NR	31.314.085.01-2			-	-	-	-	-	-	-	-	-	-	-	-

DYNAMIC 3TIBASE®

	GINGIVAL HEIGHT	α_s	α_s	α_s
	0,3 mm	CH=5mm	CH= 7mm	CH= 9mm
R	-	30°	25°	20°
NR	31.314.085.21-2			

DYNAMIC μSCANBODY (LAB/CLIN) DIGITAL ANALOG

SCANBODY	HEIGHT mm	ADAPTOR	SCREWDRIVER ADAPTOR	DIGITAL ANALOG
52.410.117.01-2	10	50.314.085.01-2	43.621.410.01-2 43.624.410.01-2	34.614.085.01-2
52.412.117.01-2	12			

DYNAMIC MILLING TOOL

DYNAMIC MILLING TOOL	SHANK	α_{di}
33.345.856.01-2	3	25°
33.445.856.01-2	4	
33.645.856.01-2	6	

DYNAMIC SCREWS

DYNAMIC SCREW	HIGH DYNAMIC SCREW	DYNAMIC SCREWDRIVER	SCREWDRIVER LENGTH (mm)
41.316.081.01-2	-	43.618.201.01-2	18
		43.624.201.01-2	24
		43.632.201.01-2	32

STRAIGHT SCREWS

STRAIGHT SCREW	SCREWDRIVER Hex. 1.25
40.316.004.02-2	43.601.104.01-2

ANALOG	LAB SCANBODY
-	30.413.002.01-2

LIBRARY OPTIONS

GH = Gingival Height
CH = Cement Height
IG = Adaptor 3mm
 α_s = Standard maximum angulation
 α_c = Captive maximum angulation
 α_{di} = Direct to implant maximum angulation
 α_{dp} = Dynamic Premilled maximum angulation

R = Rotational / Non-Engaging
NR = Non Rotational / Engaging

STANDARD DYNAMIC TIBASE®

	GINGIVAL HEIGHT	α_s	α_c	GINGIVAL HEIGHT	α_s	α_c	GINGIVAL HEIGHT	α_s	α_c	GINGIVAL HEIGHT	α_s	α_c	GINGIVAL HEIGHT	α_s	α_c
	1 mm			mm			mm			mm			mm		
R	31.325.086.01-2	45°	30°	-	-	-	-	-	-	-	-	-	-	-	-
NR	31.315.086.01-2			-	-	-	-	-	-	-	-	-	-	-	-

DYNAMIC 3TIBASE®

	GINGIVAL HEIGHT	α_s	α_s	α_s
		CH=5mm	CH= 7mm	CH= 9mm
R	-	-	-	-
NR	-			

DYNAMIC μSCANBODY (LAB/CLIN) DIGITAL ANALOG

SCANBODY	HEIGHT mm	ADAPTOR	SCREWDRIVER ADAPTOR	DIGITAL ANALOG
52.410.117.01-2	10	50.314.085.01-2	43.621.410.01-2 43.624.410.01-2	-
52.412.117.01-2	12			

DYNAMIC MILLING TOOL

DYNAMIC MILLING TOOL	SHANK	α_{di}
33.345.856.01-2	3	25°
33.445.856.01-2	4	
33.645.856.01-2	6	

DYNAMIC SCREWS

DYNAMIC SCREW	HIGH DYNAMIC SCREW	DYNAMIC SCREWDRIVER	SCREWDRIVER LENGTH (mm)
41.316.081.01-2	-	43.618.201.01-2	18
		43.624.201.01-2	24
		43.632.201.01-2	32

STRAIGHT SCREWS

STRAIGHT SCREW	SCREWDRIVER Hex. 1.25
40.316.004.02-2	43.601.104.01-2

ANALOG	LAB SCANBODY
-	30.415.007.01-2

LIBRARY OPTIONS

GH = Gingival Height
CH = Cement Height
IG = Adaptor 3mm
 α_s = Standard maximum angulation
 α_c = Captive maximum angulation
 α_{di} = Direct to implant maximum angulation
 α_{dp} = Dynamic Premilled maximum angulation

R = Rotational / Non-Engaging
NR = Non Rotational / Engaging

STANDARD DYNAMIC TIBASE®															
	GINGIVAL HEIGHT	α_s	α_c	GINGIVAL HEIGHT	α_s	α_c	GINGIVAL HEIGHT	α_s	α_c	GINGIVAL HEIGHT	α_s	α_c	GINGIVAL HEIGHT	α_s	α_c
	0,3 mm			mm			mm			mm			mm		
R	31.321.087.01-2	25°	-	-	-	-	-	-	-	-	-	-	-	-	-
NR	31.311.087.01-2		-	-	-	-	-	-	-	-	-	-	-	-	-

DYNAMIC 3TIBASE®								
	GINGIVAL HEIGHT	α_s	α_s	α_s	GINGIVAL HEIGHT	α_s	α_s	α_s
	0,3 mm	CH=5mm	CH= 7mm	CH= 9mm	2 mm	CH=5mm	CH= 7mm	CH= 9mm
R	-	20°	20°	15°	-	25°	20°	15°
NR	31.311.087.21-2				31.311.087.23-2			

DYNAMIC μ SCANBODY (LAB/CLIN)				DIGITAL ANALOG	DYNAMIC MILLING TOOL		
SCANBODY	HEIGHT mm	ADAPTOR	SCREWDRIVER ADAPTOR	DIGITAL ANALOG	DYNAMIC MILLING TOOL	SHANK	α_{di}
52.410.132.01-2	10	50.311.087.04-2 (IG=3mm)	43.621.415.01-2	-	-	-	-
				-	-	-	
52.412.132.01-2	12			-	-	-	

DYNAMIC SCREWS				STRAIGHT SCREWS		ANALOG		LAB SCANBODY	
DYNAMIC SCREW	HIGH DYNAMIC SCREW	DYNAMIC SCREWDRIVER	SCREWDRIVER LENGTH (mm)	STRAIGHT SCREW	SCREWDRIVER Hex. 1.27				
41.316.094.01-2	-	43.618.201.01-2	18	40.316.005.04-2	43.601.105.01-2	-	30.410.006.01-2		
		43.624.201.01-2	24						
		43.632.201.01-2	32						

LIBRARY OPTIONS
GH = Gingival Height
CH = Cement Height
IG = Adaptor 3mm
 α_s = Standard maximum angulation
 α_c = Captive maximum angulation
 α_{di} = Direct to implant maximum angulation
 α_{dp} = Dynamic Premilled maximum angulation
R = Rotational / Non-Engaging
NR = Non Rotational / Engaging

STANDARD DYNAMIC TIBASE®															
	GINGIVAL HEIGHT	α_s	α_c	GINGIVAL HEIGHT	α_s	α_c	GINGIVAL HEIGHT	α_s	α_c	GINGIVAL HEIGHT	α_s	α_c	GINGIVAL HEIGHT	α_s	α_c
	0,3 mm			mm			mm			mm			mm		
R	31.324.088.01-2	25°	-	-	-	-	-	-	-	-	-	-	-	-	-
NR	31.314.088.01-2		-	-	-	-	-	-	-	-	-	-	-	-	-

DYNAMIC 3TIBASE®				
	GINGIVAL HEIGHT	α_s	α_s	α_s
		CH=5mm	CH= 7mm	CH= 9mm
R	-	-	-	-
NR	-	-	-	-

DYNAMIC μ SCANBODY (LAB/CLIN)				DIGITAL ANALOG	DYNAMIC MILLING TOOL		
SCANBODY	HEIGHT mm	ADAPTOR	SCREWDRIVER ADAPTOR	DIGITAL ANALOG	DYNAMIC MILLING TOOL	SHANK	α_{di}
-	-	-	-	-	-	-	-
				-	-	-	
-	-			-	-	-	

DYNAMIC SCREWS				STRAIGHT SCREWS		ANALOG		LAB SCANBODY	
DYNAMIC SCREW	HIGH DYNAMIC SCREW	DYNAMIC SCREWDRIVER	SCREWDRIVER LENGTH (mm)	STRAIGHT SCREW	SCREWDRIVER Hex. 1.27				
41.320.094.01-2	-	43.618.201.01-2	18	40.320.005.04-2	43.601.105.01-2	-	30.414.003.01-2		
		43.624.201.01-2	24						
		43.632.201.01-2	32						

LIBRARY OPTIONS
GH = Gingival Height
CH = Cement Height
IG = Adaptor 3mm
 α_s = Standard maximum angulation
 α_c = Captive maximum angulation
 α_{di} = Direct to implant maximum angulation
 α_{dp} = Dynamic Premilled maximum angulation
R = Rotational / Non-Engaging
NR = Non Rotational / Engaging

STANDARD DYNAMIC TIBASE®															
	GINGIVAL HEIGHT	α_s	α_c	GINGIVAL HEIGHT	α_s	α_c	GINGIVAL HEIGHT	α_s	α_c	GINGIVAL HEIGHT	α_s	α_c	GINGIVAL HEIGHT	α_s	α_c
	1 mm			2 mm			3 mm			mm			mm		
R	31.321.090.01-2	45°	24°	31.321.090.02-2	25°	-	31.321.090.03-2	20°	-	-	-	-	-	-	-
NR	31.311.090.01-2			31.311.090.02-2			31.311.090.03-2			-			-		

DYNAMIC 3TIBASE®				
	GINGIVAL HEIGHT	α_s	α_s	α_s
	1 mm	CH=5mm	CH= 7mm	CH= 9mm
R	-	30°	25°	15°
NR	31.311.090.21-2			

DYNAMIC μ SCANBODY (LAB/CLIN)				DIGITAL ANALOG
SCANBODY	HEIGHT mm	ADAPTOR	SCREWDRIVER ADAPTOR	DIGITAL ANALOG
52.410.128.01-2	10	50.311.090.03-2 (IG=3mm)	43.621.415.01-2	34.611.090.01-2
-	-			
-	-			

DYNAMIC MILLING TOOL		
DYNAMIC MILLING TOOL	SHANK	α_{di}
33.325.472.01-2*	3	25°
33.425.472.01-2*	4	
33.625.472.01-2*	6	

*Only for R
*Only for titanium and soft materials

DYNAMIC SCREWS			
DYNAMIC SCREW	HIGH DYNAMIC SCREW	DYNAMIC SCREWDRIVER	SCREWDRIVER LENGTH (mm)
41.314.074.01-2	-	43.618.201.01-2	18
		43.624.201.01-2	24
		43.632.201.01-2	32

STRAIGHT SCREWS	
STRAIGHT SCREW	SCREWDRIVER Hex. 1.27
40.314.005.01-2	43.601.105.01-2

ANALOG	LAB SCANBODY
-	30.410.006.01-2

LIBRARY OPTIONS

GH = Gingival Height
CH = Cement Height
IG = Adaptor 3mm

α_s = Standard maximum angulation
 α_c = Captive maximum angulation
 α_{di} = Direct to implant maximum angulation
 α_{dp} = Dynamic Premilled maximum angulation

R = Rotational / Non-Engaging
NR = Non Rotational / Engaging

STANDARD DYNAMIC TIBASE®															
	GINGIVAL HEIGHT	α_s	α_c	GINGIVAL HEIGHT	α_s	α_c	GINGIVAL HEIGHT	α_s	α_c	GINGIVAL HEIGHT	α_s	α_c	GINGIVAL HEIGHT	α_s	α_c
	1,2 mm			2 mm			3 mm			4 mm			mm		
R	31.324.091.01-2	38°	18°	31.324.091.02-2	25°	-	31.324.091.03-2	20°	-	31.324.091.04-2	15°	-	-	-	-
NR	31.314.091.01-2			31.314.091.02-2			31.314.091.03-2			31.314.091.04-2			-		

DYNAMIC 3TIBASE®				
	GINGIVAL HEIGHT	α_s	α_s	α_s
	1,2 mm	CH=5mm	CH= 7mm	CH= 9mm
R	-	30°	25°	15°
NR	31.314.091.21-2			

DYNAMIC μ SCANBODY (LAB/CLIN)				DIGITAL ANALOG
SCANBODY	HEIGHT mm	ADAPTOR	SCREWDRIVER ADAPTOR	DIGITAL ANALOG
52.410.102.01-2	10	50.314.091.03-2 (IG=3mm)	43.621.410.01-2 43.624.410.01-2	34.614.091.01-2
-	-			
52.412.102.01-2	12			

DYNAMIC MILLING TOOL		
DYNAMIC MILLING TOOL	SHANK	α_{di}
33.390.958.01-2	3	30°
33.490.958.01-2	4	
33.690.958.01-2	6	

DYNAMIC SCREWS			
DYNAMIC SCREW	HIGH DYNAMIC SCREW	DYNAMIC SCREWDRIVER	SCREWDRIVER LENGTH (mm)
41.320.082.01-2	41.320.129.01-2	43.618.201.01-2	18
		43.624.201.01-2	24
		43.632.201.01-2	32

STRAIGHT SCREWS	
STRAIGHT SCREW	SCREWDRIVER Hex. 1.27
40.320.005.01-2	43.601.105.01-2

ANALOG	LAB SCANBODY
-	30.413.002.01-2

MULTI-UNIT				
	GINGIVAL HEIGHT	GINGIVAL HEIGHT	GINGIVAL HEIGHT	GINGIVAL HEIGHT
	1 mm	2 mm	3 mm	4 mm
R	42.303.091.01-2	42.303.091.02-2	42.303.091.03-2	42.303.091.04-2

LIBRARY OPTIONS

GH = Gingival Height
CH = Cement Height
IG = Adaptor 3mm

α_s = Standard maximum angulation
 α_c = Captive maximum angulation
 α_{di} = Direct to implant maximum angulation
 α_{dp} = Dynamic Premilled maximum angulation

R = Rotational / Non-Engaging
NR = Non Rotational / Engaging

STANDARD DYNAMIC TIBASE®															
	GINGIVAL HEIGHT	α_s	α_c	GINGIVAL HEIGHT	α_s	α_c	GINGIVAL HEIGHT	α_s	α_c	GINGIVAL HEIGHT	α_s	α_c	GINGIVAL HEIGHT	α_s	α_c
	1 mm			2 mm			3 mm			mm			mm		
R	31.325.092.01-2	45°	25°	31.325.092.02-2	25°	-	31.325.092.03-2	20°	-	-	-	-	-	-	-
NR	31.315.092.01-2			31.315.092.02-2			31.315.092.03-2			-			-		

DYNAMIC 3TIBASE®				
	GINGIVAL HEIGHT	α_s	α_s	α_s
	1 mm	CH=5mm	CH= 7mm	CH= 9mm
R	-	30°	25°	15°
NR	31.315.092.21-2			

DYNAMIC μ SCANBODY (LAB/CLIN)				DIGITAL ANALOG
SCANBODY	HEIGHT mm	ADAPTOR	SCREWDRIVER ADAPTOR	DIGITAL ANALOG
52.410.129.01-2	10	50.315.092.01-2 50.315.092.03-2 (IG=3mm)	43.621.410.01-2	34.615.092.01-2
-	-		43.624.410.01-2	
-	-		-	

DYNAMIC MILLING TOOL		
DYNAMIC MILLING TOOL	SHANK	α_{di}
33.390.958.01-2	3	30°
33.490.958.01-2	4	
33.690.958.01-2	6	

DYNAMIC SCREWS			
DYNAMIC SCREW	HIGH DYNAMIC SCREW	DYNAMIC SCREWDRIVER	SCREWDRIVER LENGTH (mm)
41.320.082.01-2	-	43.618.201.01-2	18
		43.624.201.01-2	24
		43.632.201.01-2	32

STRAIGHT SCREWS	
STRAIGHT SCREW	SCREWDRIVER Hex. 1.27
40.320.005.01-2	43.601.105.01-2

ANALOG	LAB SCANBODY
-	30.415.007.01-2

LIBRARY OPTIONS

GH = Gingival Height
CH = Cement Height
IG = Adaptor 3mm

α_s = Standard maximum angulation
 α_c = Captive maximum angulation
 α_{di} = Direct to implant maximum angulation
 α_{dp} = Dynamic Premilled maximum angulation

R = Rotational / Non-Engaging
NR = Non Rotational / Engaging

STANDARD DYNAMIC TIBASE®															
	GINGIVAL HEIGHT	α_s	α_c	GINGIVAL HEIGHT	α_s	α_c	GINGIVAL HEIGHT	α_s	α_c	GINGIVAL HEIGHT	α_s	α_c	GINGIVAL HEIGHT	α_s	α_c
	0,6 mm			mm			mm			mm			mm		
R	31.324.096.01-2	45°	30°	-	-	-	-	-	-	-	-	-	-	-	-
NR	31.314.096.01-2			-			-			-			-		

DYNAMIC 3TIBASE®				
	GINGIVAL HEIGHT	α_s	α_s	α_s
		CH=5mm	CH= 7mm	CH= 9mm
R	-	-	-	-
NR	-			

DYNAMIC μ SCANBODY (LAB/CLIN)				DIGITAL ANALOG
SCANBODY	HEIGHT mm	ADAPTOR	SCREWDRIVER ADAPTOR	DIGITAL ANALOG
52.408.110.01-2	8	50.314.096.01-2	43.621.410.01-2	34.614.096.01-2
52.410.110.01-2	10		43.624.410.01-2	
52.412.110.01-2	12		-	

DYNAMIC MILLING TOOL		
DYNAMIC MILLING TOOL	SHANK	α_{di}
33.315.708.01-2	3	30°
33.415.708.01-2	4	
33.615.708.01-2	6	

SCANALOG
23.414.096.01-2

DYNAMIC SCREWS			
DYNAMIC SCREW	HIGH DYNAMIC SCREW	DYNAMIC SCREWDRIVER	SCREWDRIVER LENGTH (mm)
41.320.067.01-2	-	43.618.201.01-2	18
		43.624.201.01-2	24
		43.632.201.01-2	32

STRAIGHT SCREWS	
STRAIGHT SCREW	SCREWDRIVER TORX T6
40.320.007.01-2	43.601.107.01-2

ANALOG	LAB SCANBODY
22.614.096.01-2	30.414.008.01-2

LIBRARY OPTIONS

GH = Gingival Height
CH = Cement Height
IG = Adaptor 3mm

α_s = Standard maximum angulation
 α_c = Captive maximum angulation
 α_{di} = Direct to implant maximum angulation
 α_{dp} = Dynamic Premilled maximum angulation

R = Rotational / Non-Engaging
NR = Non Rotational / Engaging

STANDARD DYNAMIC TIBASE®															
	GINGIVAL HEIGHT	α_s	α_c	GINGIVAL HEIGHT	α_s	α_c	GINGIVAL HEIGHT	α_s	α_c	GINGIVAL HEIGHT	α_s	α_c	GINGIVAL HEIGHT	α_s	α_c
	0,5 mm			mm			mm			mm			mm		
R	31.323.101.01-2	45°	30°	-	-	-	-	-	-	-	-	-	-	-	-
NR	-			-			-			-			-		

DYNAMIC 3TIBASE®				
	GINGIVAL HEIGHT	α_s	α_s	α_s
		CH=5mm	CH=7mm	CH=9mm
R	-	-	-	-
NR	-	-	-	-

DYNAMIC μ SCANBODY (LAB/CLIN)				DIGITAL ANALOG
SCANBODY	HEIGHT mm	ADAPTOR	SCREWDRIVER ADAPTOR	DIGITAL ANALOG
52.409.133.01-2	9	50.313.101.01-2	43.621.410.01-2	34.613.101.01-2
-	-		43.624.410.01-2	
-	-		-	

DYNAMIC MILLING TOOL			
DYNAMIC MILLING TOOL	SHANK	α_{di}	
33.335.676.01-2	3	30°	23.413.101.01-2
33.435.676.01-2	4		
33.635.676.01-2	6		

SCANALOG			REFERENCE SCANBODY		
SCANBODY	PEEK PINS	mm	SCANBODY	PEEK PINS	mm
-	49.414.000.01-2	6	54.322.101.31-2	49.415.000.01-2	9
-	49.415.000.01-2	9	-	49.416.000.01-2	13

DYNAMIC SCREWS			
DYNAMIC SCREW	HIGH DYNAMIC SCREW	DYNAMIC SCREWDRIVER	SCREWDRIVER LENGTH (mm)
41.314.043.01-2	-	43.618.201.01-2	18
		43.624.201.01-2	24
		43.632.201.01-2	32

STRAIGHT SCREWS	
STRAIGHT SCREW	SCREWDRIVER TORX T6
40.314.007.01-2	43.601.107.01-2

ANALOG	LAB SCANBODY
-	30.413.005.01-2

LIBRARY OPTIONS
GH = Gingival Height
CH = Cement Height
IG = Adaptor 3mm
 α_s = Standard maximum angulation
 α_c = Captive maximum angulation
 α_{di} = Direct to implant maximum angulation
 α_{dp} = Dynamic Premilled maximum angulation
R = Rotational / Non-Engaging
NR = Non Rotational / Engaging

STANDARD DYNAMIC TIBASE®															
	GINGIVAL HEIGHT	α_s	α_c	GINGIVAL HEIGHT	α_s	α_c	GINGIVAL HEIGHT	α_s	α_c	GINGIVAL HEIGHT	α_s	α_c	GINGIVAL HEIGHT	α_s	α_c
	1,8 mm			mm			mm			mm			mm		
R	31.322.102.01-2	38°	18°	-	-	-	-	-	-	-	-	-	-	-	-
NR	31.312.102.01-2			-			-			-			-		

DYNAMIC 3TIBASE®												
	GINGIVAL HEIGHT	α_s	α_s	α_s	GINGIVAL HEIGHT	α_s	α_s	α_s	GINGIVAL HEIGHT	α_s	α_s	
	1 mm	CH=5mm	CH=7mm	CH=9mm	1,8 mm	CH=5mm	CH=7mm	CH=9mm	3 mm	CH=5mm	CH=7mm	CH=9mm
R	31.322.102.29-2	30°	25°	20°	31.322.102.21-2	25°	15°	10°	31.322.102.23-2	20°	20°	15°
NR	31.312.102.29-2				31.312.102.21-2				31.312.102.23-2			

DYNAMIC μ SCANBODY (LAB/CLIN)				DIGITAL ANALOG
SCANBODY	HEIGHT mm	ADAPTOR	SCREWDRIVER ADAPTOR	DIGITAL ANALOG
52.410.128.01-2	10	50.312.102.03-2 (IG=3mm)	43.621.415.01-2	34.612.102.01-2
-	-		-	
-	-		-	

DYNAMIC MILLING TOOL		
DYNAMIC MILLING TOOL	SHANK	α_{di}
-	-	-
-	-	-
-	-	-

SCANALOG
23.412.102.01-2

DYNAMIC SCREWS			
DYNAMIC SCREW	HIGH DYNAMIC SCREW	DYNAMIC SCREWDRIVER	SCREWDRIVER LENGTH (mm)
41.317.065.01-2	-	43.618.201.01-2	18
		43.624.201.01-2	24
		43.632.201.01-2	32

STRAIGHT SCREWS	
STRAIGHT SCREW	SCREWDRIVER Hex. 1.27
40.317.005.02-2	43.601.105.01-2

ANALOG	LAB SCANBODY
-	30.412.001.01-2

MULTI-UNIT				
	GINGIVAL HEIGHT	GINGIVAL HEIGHT	GINGIVAL HEIGHT	GINGIVAL HEIGHT
	1 mm	2 mm	3 mm	4 mm
R	42.302.102.01-2	42.302.102.02-2	42.302.102.03-2	42.302.102.04-2

LIBRARY OPTIONS
GH = Gingival Height
CH = Cement Height
IG = Adaptor 3mm
 α_s = Standard maximum angulation
 α_c = Captive maximum angulation
 α_{di} = Direct to implant maximum angulation
 α_{dp} = Dynamic Premilled maximum angulation
R = Rotational / Non-Engaging
NR = Non Rotational / Engaging

COMPATIBLE with 0109

STANDARD DYNAMIC TIBASE®															
	GINGIVAL HEIGHT	α_s	α_c	GINGIVAL HEIGHT	α_s	α_c	GINGIVAL HEIGHT	α_s	α_c	GINGIVAL HEIGHT	α_s	α_c	GINGIVAL HEIGHT	α_s	α_c
	1,2 mm			mm			mm			mm			mm		
R	31.322.109.01-2	45°	29°	-	-	-	-	-	-	-	-	-	-	-	-
NR	31.312.109.01-2			-	-	-	-	-	-	-	-	-	-	-	-

DYNAMIC 3TIBASE®				
	GINGIVAL HEIGHT	α_s	α_s	α_s
		CH=5mm	CH= 7mm	CH= 9mm
R	-	-	-	-
NR	-	-	-	-

DYNAMIC μSCANBODY (LAB/CLIN)				DIGITAL ANALOG
SCANBODY	HEIGHT mm	ADAPTOR	SCREWDRIVER ADAPTOR	DIGITAL ANALOG
52.410.128.01-2	10	50.312.109.01-2	43.621.415.01-2	34.612.109.01-2
-	-			
-	-			

DYNAMIC MILLING TOOL		
DYNAMIC MILLING TOOL	SHANK	α_{di}
33.360.754.01-2*	3	25°
33.460.754.01-2*	4	
33.660.754.01-2*	6	

*Only for R

DYNAMIC SCREWS			
DYNAMIC SCREW	HIGH DYNAMIC SCREW	DYNAMIC SCREWDRIVER	SCREWDRIVER LENGTH (mm)
41.314.070.01-2	-	43.618.201.01-2	18
		43.624.201.01-2	24
		43.632.201.01-2	32

STRAIGHT SCREWS	
STRAIGHT SCREW	SCREWDRIVER Hex. 1.27
40.314.005.02-2	43.601.105.01-2

ANALOG	LAB SCANBODY
-	30.412.001.01-2

LIBRARY OPTIONS

GH = Gingival Height
CH = Cement Height
IG = Adaptor 3mm

α_s = Standard maximum angulation
 α_c = Captive maximum angulation
 α_{di} = Direct to implant maximum angulation
 α_{dp} = Dynamic Premilled maximum angulation

R = Rotational / Non-Engaging
NR = Non Rotational / Engaging

COMPATIBLE with 0110

STANDARD DYNAMIC TIBASE®															
	GINGIVAL HEIGHT	α_s	α_c	GINGIVAL HEIGHT	α_s	α_c	GINGIVAL HEIGHT	α_s	α_c	GINGIVAL HEIGHT	α_s	α_c	GINGIVAL HEIGHT	α_s	α_c
	0,4 mm			mm			mm			mm			mm		
R	31.320.110.01-2	45°	30°	-	-	-	-	-	-	-	-	-	-	-	-
NR	31.310.110.01-2			-	-	-	-	-	-	-	-	-	-	-	-

DYNAMIC 3TIBASE®				
	GINGIVAL HEIGHT	α_s	α_s	α_s
		CH=5mm	CH= 7mm	CH= 9mm
R	-	-	-	-
NR	-	-	-	-

DYNAMIC μSCANBODY (LAB/CLIN)				DIGITAL ANALOG
SCANBODY	HEIGHT mm	ADAPTOR	SCREWDRIVER ADAPTOR	DIGITAL ANALOG
52.410.117.01-2	10	50.310.110.04-2 IG=3mm	43.621.410.01-2 43.624.410.01-2	34.610.110.01-2
-	-			
52.412.117.01-2	12			

DYNAMIC MILLING TOOL		
DYNAMIC MILLING TOOL	SHANK	α_{di}
33.360.756.01-2	3	20°
33.460.756.01-2	4	
33.660.756.01-2	6	

DYNAMIC SCREWS			
DYNAMIC SCREW	HIGH DYNAMIC SCREW	DYNAMIC SCREWDRIVER	SCREWDRIVER LENGTH (mm)
41.318.083.01-2	-	43.618.201.01-2	18
		43.624.201.01-2	24
		43.632.201.01-2	32

STRAIGHT SCREWS	
STRAIGHT SCREW	SCREWDRIVER TORX T6
40.318.007.01-2	43.601.107.01-2

ANALOG	LAB SCANBODY
-	30.410.006.01-2

LIBRARY OPTIONS

GH = Gingival Height
CH = Cement Height
IG = Adaptor 3mm

α_s = Standard maximum angulation
 α_c = Captive maximum angulation
 α_{di} = Direct to implant maximum angulation
 α_{dp} = Dynamic Premilled maximum angulation

R = Rotational / Non-Engaging
NR = Non Rotational / Engaging

STANDARD DYNAMIC TIBASE®															
	GINGIVAL HEIGHT	α_s	α_c	GINGIVAL HEIGHT	α_s	α_c	GINGIVAL HEIGHT	α_s	α_c	GINGIVAL HEIGHT	α_s	α_c	GINGIVAL HEIGHT	α_s	α_c
	0,4 mm			mm			mm			mm			mm		
R	31.323.111.01-2	45°	30°	-	-	-	-	-	-	-	-	-	-	-	-
NR	31.313.111.01-2			-	-	-	-	-	-	-	-	-	-	-	-

DYNAMIC 3TIBASE®				
	GINGIVAL HEIGHT	α_s	α_s	α_s
		CH=5mm	CH=7mm	CH=9mm
R	-	-	-	-
NR	-	-	-	-

DYNAMIC μ SCANBODY (LAB/CLIN)				DIGITAL ANALOG
SCANBODY	HEIGHT mm	ADAPTOR	SCREWDRIVER ADAPTOR	DIGITAL ANALOG
52.410.117.01-2	10	50.310.110.04-2 IG=3mm	43.621.410.01-2 43.624.410.01-2	34.610.110.01-2
52.412.117.01-2	12			

DYNAMIC MILLING TOOL			
DYNAMIC MILLING TOOL	SHANK	α_{di}	
33.360.756.01-2	3	20°	
33.460.756.01-2	4		
33.660.756.01-2	6		

DYNAMIC SCREWS			
DYNAMIC SCREW	HIGH DYNAMIC SCREW	DYNAMIC SCREWDRIVER	SCREWDRIVER LENGTH (mm)
41.318.083.01-2	-	43.618.201.01-2	18
		43.624.201.01-2	24
		43.632.201.01-2	32

STRAIGHT SCREWS	
STRAIGHT SCREW	SCREWDRIVER TORX T6
40.318.007.01-2	43.601.107.01-2

ANALOG	LAB SCANBODY
-	30.413.002.01-2

LIBRARY OPTIONS
GH = Gingival Height
CH = Cement Height
IG = Adaptor 3mm
 α_s = Standard maximum angulation
 α_c = Captive maximum angulation
 α_{di} = Direct to implant maximum angulation
 α_{dp} = Dynamic Premilled maximum angulation
R = Rotational / Non-Engaging
NR = Non Rotational / Engaging

STANDARD DYNAMIC TIBASE®															
	GINGIVAL HEIGHT	α_s	α_c	GINGIVAL HEIGHT	α_s	α_c	GINGIVAL HEIGHT	α_s	α_c	GINGIVAL HEIGHT	α_s	α_c	GINGIVAL HEIGHT	α_s	α_c
	1 mm			2 mm			mm			mm			mm		
R	31.321.119.01-2	35°	-	31.321.119.02-2	30°	-	-	-	-	-	-	-	-	-	-
NR	31.311.119.01-2			31.311.119.02-2			-	-	-	-	-	-	-	-	-

DYNAMIC 3TIBASE®				
	GINGIVAL HEIGHT	α_s	α_s	α_s
		CH=5mm	CH=7mm	CH=9mm
R	-	-	-	-
NR	-	-	-	-

DYNAMIC μ SCANBODY (LAB/CLIN)				DIGITAL ANALOG
SCANBODY	HEIGHT mm	ADAPTOR	SCREWDRIVER ADAPTOR	DIGITAL ANALOG
52.410.132.01-2	10	50.311.119.03-2 IG=3mm	43.621.410.01-2 43.624.410.01-2	34.611.119.01-2
52.412.132.01-2	12			

DYNAMIC MILLING TOOL		
DYNAMIC MILLING TOOL	SHANK	α_{di}
33.360.756.01-2	3	25
33.460.756.01-2	4	
33.660.756.01-2	6	

DYNAMIC SCREWS			
DYNAMIC SCREW	HIGH DYNAMIC SCREW	DYNAMIC SCREWDRIVER	SCREWDRIVER LENGTH (mm)
41.316.080.01-2	-	43.618.201.01-2	18
		43.624.201.01-2	24
		43.632.201.01-2	32

STRAIGHT SCREWS	
STRAIGHT SCREW	SCREWDRIVER Hex. 1,27
40.316.005.07-2	43.601.105.01-2

ANALOG	LAB SCANBODY
-	30.410.006.01-2

MULTI-UNIT				
	GINGIVAL HEIGHT	GINGIVAL HEIGHT	GINGIVAL HEIGHT	GINGIVAL HEIGHT
	1 mm	2 mm	3 mm	4 mm
R	42.301.119.01-2	42.301.119.02-2	42.301.119.03-2	42.301.119.04-2

LIBRARY OPTIONS
GH = Gingival Height
CH = Cement Height
IG = Adaptor 3mm
 α_s = Standard maximum angulation
 α_c = Captive maximum angulation
 α_{di} = Direct to implant maximum angulation
 α_{dp} = Dynamic Premilled maximum angulation
R = Rotational / Non-Engaging
NR = Non Rotational / Engaging

STANDARD DYNAMIC TIBASE®															
	GINGIVAL HEIGHT	α_s	α_c	GINGIVAL HEIGHT	α_s	α_c	GINGIVAL HEIGHT	α_s	α_c	GINGIVAL HEIGHT	α_s	α_c	GINGIVAL HEIGHT	α_s	α_c
	1 mm			mm			mm			mm			mm		
R	31.323.121.01-2	45°	25°	-	-	-	-	-	-	-	-	-	-	-	-
NR	31.313.121.01-2			-	-	-	-	-	-	-	-	-	-	-	-

DYNAMIC 3TIBASE®								
	GINGIVAL HEIGHT	α_s	α_s	α_s	GINGIVAL HEIGHT	α_s	α_s	α_s
	2mm	CH=5mm	CH= 7mm	CH= 9mm	3mm	CH=5mm	CH= 7mm	CH= 9mm
R	-	25°	20°	15°	-	25°	20°	10°
NR	31.313.121.22-2				31.313.121.23-2			

DYNAMIC μ SCANBODY (LAB/CLIN)				DIGITAL ANALOG	DYNAMIC MILLING TOOL		
SCANBODY	HEIGHT mm	ADAPTOR	SCREWDRIVER ADAPTOR	DIGITAL ANALOG	DYNAMIC MILLING TOOL	SHANK	α_{di}
52.410.108.01-2	10	50.312.120.03-2 IG=3mm	43.621.410.01-2 43.624.410.01-2	34.612.120.01-2	33.360.754.01-2	3	20°
					33.460.754.01-2	4	
52.412.108.01-2	12				33.660.754.01-2	6	

DYNAMIC SCREWS			
DYNAMIC SCREW	HIGH DYNAMIC SCREW	DYNAMIC SCREWDRIVER	SCREWDRIVER LENGTH (mm)
41.316.080.01-2	-	43.618.201.01-2	18
		43.624.201.01-2	24
		43.632.201.01-2	32

STRAIGHT SCREWS	
STRAIGHT SCREW	SCREWDRIVER Hex. 1.27
40.316.005.07-2	43.601.105.01-2

ANALOG	LAB SCANBODY
-	30.413.002.01-2

MULTI-UNIT				
	GINGIVAL HEIGHT	GINGIVAL HEIGHT	GINGIVAL HEIGHT	GINGIVAL HEIGHT
	1 mm	2 mm	3 mm	4 mm
R	42.303.121.01-2	42.303.121.02-2	42.303.121.03-2	42.303.121.04-2

LIBRARY OPTIONS
GH = Gingival Height
CH = Cement Height
IG = Adaptor 3mm
 α_s = Standard maximum angulation
 α_c = Captive maximum angulation
 α_{di} = Direct to implant maximum angulation
 α_{dp} = Dynamic Premilled maximum angulation
R = Rotational / Non-Engaging
NR = Non Rotational / Engaging

STANDARD DYNAMIC TIBASE®															
	GINGIVAL HEIGHT	α_s	α_c	GINGIVAL HEIGHT	α_s	α_c	GINGIVAL HEIGHT	α_s	α_c	GINGIVAL HEIGHT	α_s	α_c	GINGIVAL HEIGHT	α_s	α_c
	1 mm			mm			mm			mm			mm		
R	31.323.121.01-2	45°	25°	-	-	-	-	-	-	-	-	-	-	-	-
NR	31.313.121.01-2			-	-	-	-	-	-	-	-	-	-	-	-

DYNAMIC 3TIBASE®								
	GINGIVAL HEIGHT	α_s	α_s	α_s	GINGIVAL HEIGHT	α_s	α_s	α_s
	2mm	CH=5mm	CH= 7mm	CH= 9mm	3mm	CH=5mm	CH= 7mm	CH= 9mm
R	-	25°	20°	15°	-	25°	20°	10°
NR	31.313.121.22-2				31.313.121.23-2			

DYNAMIC μ SCANBODY (LAB/CLIN)				DIGITAL ANALOG	DYNAMIC MILLING TOOL		
SCANBODY	HEIGHT mm	ADAPTOR	SCREWDRIVER ADAPTOR	DIGITAL ANALOG	DYNAMIC MILLING TOOL	SHANK	α_{di}
52.410.109.01-2	10	50.313.121.01-2 50.313.121.03-2 IG=3mm	43.621.410.01-2 43.624.410.01-2	34.613.121.01-2	33.360.754.01-2	3	20°
					33.460.754.01-2	4	
52.412.109.01-2	12				33.660.754.01-2	6	

DYNAMIC SCREWS			
DYNAMIC SCREW	HIGH DYNAMIC SCREW	DYNAMIC SCREWDRIVER	SCREWDRIVER LENGTH (mm)
41.316.080.01-2	-	43.618.201.01-2	18
		43.624.201.01-2	24
		43.632.201.01-2	32

STRAIGHT SCREWS	
STRAIGHT SCREW	SCREWDRIVER Hex. 1.27
40.316.005.07-2	43.601.105.01-2

ANALOG	LAB SCANBODY
-	30.413.002.01-2

MULTI-UNIT				
	GINGIVAL HEIGHT	GINGIVAL HEIGHT	GINGIVAL HEIGHT	GINGIVAL HEIGHT
	1 mm	2 mm	3 mm	4 mm
R	42.303.121.01-2	42.303.121.02-2	42.303.121.03-2	42.303.121.04-2

LIBRARY OPTIONS
GH = Gingival Height
CH = Cement Height
IG = Adaptor 3mm
 α_s = Standard maximum angulation
 α_c = Captive maximum angulation
 α_{di} = Direct to implant maximum angulation
 α_{dp} = Dynamic Premilled maximum angulation
R = Rotational / Non-Engaging
NR = Non Rotational / Engaging

STANDARD DYNAMIC TIBASE®															
	GINGIVAL HEIGHT	α_s	α_c	GINGIVAL HEIGHT	α_s	α_c	GINGIVAL HEIGHT	α_s	α_c	GINGIVAL HEIGHT	α_s	α_c	GINGIVAL HEIGHT	α_s	α_c
	1,4 mm			mm			mm			mm			mm		
R	31.324.124.01-2	42°	19°	-	-	-	-	-	-	-	-	-	-	-	-
NR	31.314.124.01-2			-	-	-	-	-	-	-	-	-	-	-	-

DYNAMIC 3TIBASE®				
	GINGIVAL HEIGHT	α_s	α_s	α_s
		CH=5mm	CH=7mm	CH=9mm
R	-	-	-	-
NR	-	-	-	-

DYNAMIC μ SCANBODY (LAB/CLIN)				DIGITAL ANALOG
SCANBODY	HEIGHT mm	ADAPTOR	SCREWDRIVER ADAPTOR	DIGITAL ANALOG
52.410.125.01-2	10	50.314.124.01-2	43.621.410.01-2 43.624.410.01-2	34.614.124.01-2
-	-			
-	-			

DYNAMIC MILLING TOOL			
DYNAMIC MILLING TOOL	SHANK	α_{di}	
33.335.758.01-2	3	30°	
33.435.758.01-2	4		
33.635.758.01-2	6		

DYNAMIC SCREWS			
DYNAMIC SCREW	HIGH DYNAMIC SCREW	DYNAMIC SCREWDRIVER	SCREWDRIVER LENGTH (mm)
41.320.075.01-2	-	43.618.201.01-2	18
		43.624.201.01-2	24
		43.632.201.01-2	32

STRAIGHT SCREWS	
STRAIGHT SCREW	SCREWDRIVER UNIGRIP
40.320.008.02-2	43.601.108.01-2

ANALOG	LAB SCANBODY
-	30.414.003.01-2

LIBRARY OPTIONS
 GH = Gingival Height
 CH = Cement Height
 IG = Adaptor 3mm

STANDARD DYNAMIC TIBASE®															
	GINGIVAL HEIGHT	α_s	α_c	GINGIVAL HEIGHT	α_s	α_c	GINGIVAL HEIGHT	α_s	α_c	GINGIVAL HEIGHT	α_s	α_c	GINGIVAL HEIGHT	α_s	α_c
	1,1 mm			2 mm			mm			mm			mm		
R	31.323.125.01-2	42°	20°	31.323.125.02-2	25°	-	-	-	-	-	-	-	-	-	-
NR	31.313.125.01-2			31.313.125.02-2			-			-			-		

DYNAMIC 3TIBASE®					
	GINGIVAL HEIGHT	α_s	α_s	α_s	
		1,1 mm	CH=5mm	CH=7mm	CH=9mm
R	31.323.125.21-2	30°	25°	15°	
NR	31.313.125.21-2				

DYNAMIC μ SCANBODY (LAB/CLIN)				DIGITAL ANALOG
SCANBODY	HEIGHT mm	ADAPTOR	SCREWDRIVER ADAPTOR	DIGITAL ANALOG
52.410.117.01-2	10	50.313.125.01-2	43.621.410.01-2 43.624.410.01-2	34.613.125.01-2
		50.313.125.03-2 IG=3mm		
52.412.117.01-2	12			

DYNAMIC MILLING TOOL		
DYNAMIC MILLING TOOL	SHANK	α_{di}
33.315.804.01-2	3	25°
33.415.804.01-2	4	
33.615.804.01-2	6	

DYNAMIC SCREWS			
DYNAMIC SCREW	HIGH DYNAMIC SCREW	DYNAMIC SCREWDRIVER	SCREWDRIVER LENGTH (mm)
41.316.078.01-2	-	43.618.201.01-2	18
		43.624.201.01-2	24
		43.632.201.01-2	32

STRAIGHT SCREWS	
STRAIGHT SCREW	SCREWDRIVER TORX T6
40.316.007.01-2	43.601.107.01-2

ANALOG	LAB SCANBODY
-	30.413.002.01-2

MULTI-UNIT				
	GINGIVAL HEIGHT	GINGIVAL HEIGHT	GINGIVAL HEIGHT	GINGIVAL HEIGHT
	1 mm	2 mm	3 mm	4 mm
R	42.303.125.01-2	42.303.125.02-2	42.303.125.03-2	42.303.125.04-2

LIBRARY OPTIONS
 GH = Gingival Height
 CH = Cement Height
 IG = Adaptor 3mm

α_s = Standard maximum angulation
 α_c = Captive maximum angulation
 α_{di} = Direct to implant maximum angulation
 α_{dp} = Dynamic Premilled maximum angulation

R = Rotational / Non-Engaging
NR = Non Rotational / Engaging

STANDARD DYNAMIC TIBASE®															
	GINGIVAL HEIGHT	α_s	α_c	GINGIVAL HEIGHT	α_s	α_c	GINGIVAL HEIGHT	α_s	α_c	GINGIVAL HEIGHT	α_s	α_c	GINGIVAL HEIGHT	α_s	α_c
	2,5 mm			mm			mm			mm			mm		
R	31.322.128.01-2	45°	30°	-	-	-	-	-	-	-	-	-	-	-	-
NR	-			-	-	-	-	-	-	-	-	-	-	-	-

DYNAMIC 3TIBASE®				
	GINGIVAL HEIGHT	α_s	α_s	α_s
		CH=5mm	CH= 7mm	CH= 9mm
-	-	-	-	-
-	-	-	-	-

DYNAMIC μSCANBODY (LAB/CLIN)				DIGITAL ANALOG
SCANBODY	HEIGHT mm	ADAPTOR	SCREWDRIVER ADAPTOR	DIGITAL ANALOG
-	-	-	-	-
-	-	-	-	-

DYNAMIC MILLING TOOL		
DYNAMIC MILLING TOOL	SHANK	α_{di}
-	-	-
-	-	-
-	-	-

DYNAMIC SCREWS			
DYNAMIC SCREW	HIGH DYNAMIC SCREW	DYNAMIC SCREWDRIVER	SCREWDRIVER LENGTH (mm)
41.320.044.01-2	-	43.618.201.01-2	18
		43.624.201.01-2	24
		43.632.201.01-2	32

STRAIGHT SCREWS	
STRAIGHT SCREW	SCREWDRIVER Hex. 1.20
40.320.003.05-2	43.601.103.01-2

ANALOG	LAB SCANBODY
-	30.413.002.01-2

LIBRARY OPTIONS

GH = Gingival Height
CH = Cement Height
IG = Adaptor 3mm

α_s = Standard maximum angulation
 α_c = Captive maximum angulation
 α_{di} = Direct to implant maximum angulation
 α_{dp} = Dynamic Premilled maximum angulation

R = Rotational / Non-Engaging
NR = Non Rotational / Engaging

STANDARD DYNAMIC TIBASE®															
	GINGIVAL HEIGHT	α_s	α_c	GINGIVAL HEIGHT	α_s	α_c	GINGIVAL HEIGHT	α_s	α_c	GINGIVAL HEIGHT	α_s	α_c	GINGIVAL HEIGHT	α_s	α_c
	0,3 mm			mm			mm			mm			mm		
R	31.325.129.01-2	43°	30°	-	-	-	-	-	-	-	-	-	-	-	-
NR	31.315.129.01-2			-	-	-	-	-	-	-	-	-	-	-	-

DYNAMIC 3TIBASE®				
	GINGIVAL HEIGHT	α_s	α_s	α_s
		CH=5mm	CH= 7mm	CH= 9mm
R	-	-	-	-
NR	-	-	-	-

DYNAMIC μSCANBODY (LAB/CLIN)				DIGITAL ANALOG
SCANBODY	HEIGHT mm	ADAPTOR	SCREWDRIVER ADAPTOR	DIGITAL ANALOG
52.410.130.01-2	10	50.315.129.01-2	43.621.410.01-2	34.615.129.01-2
			43.624.410.01-2	
-	-			

DYNAMIC MILLING TOOL		
DYNAMIC MILLING TOOL	SHANK	α_{di}
33.390.958.01-2	3	30°
33.490.958.01-2	4	
33.690.958.01-2	6	

DYNAMIC SCREWS			
DYNAMIC SCREW	HIGH DYNAMIC SCREW	DYNAMIC SCREWDRIVER	SCREWDRIVER LENGTH (mm)
41.320.090.01-2	-	43.618.201.01-2	18
		43.624.201.01-2	24
		43.632.201.01-2	32

STRAIGHT SCREWS	
STRAIGHT SCREW	SCREWDRIVER UNIGRIP
40.320.008.03-2	43.601.108.01-2

ANALOG	LAB SCANBODY
-	30.415.007.01-2

LIBRARY OPTIONS

GH = Gingival Height
CH = Cement Height
IG = Adaptor 3mm

α_s = Standard maximum angulation
 α_c = Captive maximum angulation
 α_{di} = Direct to implant maximum angulation
 α_{dp} = Dynamic Premilled maximum angulation

R = Rotational / Non-Engaging
NR = Non Rotational / Engaging

STANDARD DYNAMIC TIBASE®															
	GINGIVAL HEIGHT	α_s	α_c	GINGIVAL HEIGHT	α_s	α_c	GINGIVAL HEIGHT	α_s	α_c	GINGIVAL HEIGHT	α_s	α_c	GINGIVAL HEIGHT	α_s	α_c
	0,5 mm			mm			mm			mm			mm		
R	31.322.130.01-2	30°	29°	-	-	-	-	-	-	-	-	-	-	-	-
NR	31.312.130.01-2			-	-	-	-	-	-	-	-	-	-	-	-

DYNAMIC 3TIBASE®				
	GINGIVAL HEIGHT	α_s	α_s	α_s
		CH=5mm	CH= 7mm	CH= 9mm
R	-	-	-	-
NR	-	-	-	-

DYNAMIC μ SCANBODY (LAB/CLIN)				DIGITAL ANALOG
SCANBODY	HEIGHT mm	ADAPTOR	SCREWDRIVER ADAPTOR	DIGITAL ANALOG
-	-	-	-	-
-	-	-	-	-

DYNAMIC MILLING TOOL			
DYNAMIC MILLING TOOL	SHANK	α_{di}	
33.345.804.01-2	3	20°	
33.445.804.01-2	4		
33.645.804.01-2	6		

DYNAMIC SCREWS			
DYNAMIC SCREW	HIGH DYNAMIC SCREW	DYNAMIC SCREWDRIVER	SCREWDRIVER LENGTH (mm)
41.316.081.01-2	-	43.618.201.01-2	18
		43.624.201.01-2	24
		43.632.201.01-2	32

STRAIGHT SCREWS	
STRAIGHT SCREW	SCREWDRIVER Hex. 1.27
40.316.005.08-2	43.601.105.01-2

ANALOG	LAB SCANBODY
-	30.412.001.01-2

LIBRARY OPTIONS
GH = Gingival Height
CH = Cement Height
IG = Adaptor 3mm
 α_s = Standard maximum angulation
 α_c = Captive maximum angulation
 α_{di} = Direct to implant maximum angulation
 α_{dp} = Dynamic Premilled maximum angulation
R = Rotational / Non-Engaging
NR = Non Rotational / Engaging

STANDARD DYNAMIC TIBASE®															
	GINGIVAL HEIGHT	α_s	α_c	GINGIVAL HEIGHT	α_s	α_c	GINGIVAL HEIGHT	α_s	α_c	GINGIVAL HEIGHT	α_s	α_c	GINGIVAL HEIGHT	α_s	α_c
	0,5 mm			mm			mm			mm			mm		
R	31.323.131.01-2	45°	29°	-	-	-	-	-	-	-	-	-	-	-	-
NR	31.313.131.01-2			-	-	-	-	-	-	-	-	-	-	-	-

DYNAMIC 3TIBASE®				
	GINGIVAL HEIGHT	α_s	α_s	α_s
		CH=5mm	CH= 7mm	CH= 9mm
R	-	-	-	-
NR	-	-	-	-

DYNAMIC μ SCANBODY (LAB/CLIN)				DIGITAL ANALOG
SCANBODY	HEIGHT mm	ADAPTOR	SCREWDRIVER ADAPTOR	DIGITAL ANALOG
-	-	-	-	-
-	-	-	-	-

DYNAMIC MILLING TOOL			
DYNAMIC MILLING TOOL	SHANK	α_{di}	
33.345.804.01-2	3	20°	
33.445.804.01-2	4		
33.645.804.01-2	6		

DYNAMIC SCREWS			
DYNAMIC SCREW	HIGH DYNAMIC SCREW	DYNAMIC SCREWDRIVER	SCREWDRIVER LENGTH (mm)
41.316.081.01-2	-	43.618.201.01-2	18
		43.624.201.01-2	24
		43.632.201.01-2	32

STRAIGHT SCREWS	
STRAIGHT SCREW	SCREWDRIVER Hex. 1.27
40.316.005.08-2	43.601.105.01-2

ANALOG	LAB SCANBODY
-	30.413.002.01-2

LIBRARY OPTIONS
GH = Gingival Height
CH = Cement Height
IG = Adaptor 3mm
 α_s = Standard maximum angulation
 α_c = Captive maximum angulation
 α_{di} = Direct to implant maximum angulation
 α_{dp} = Dynamic Premilled maximum angulation
R = Rotational / Non-Engaging
NR = Non Rotational / Engaging

STANDARD DYNAMIC TIBASE®															
	GINGIVAL HEIGHT	α_s	α_c	GINGIVAL HEIGHT	α_s	α_c	GINGIVAL HEIGHT	α_s	α_c	GINGIVAL HEIGHT	α_s	α_c	GINGIVAL HEIGHT	α_s	α_c
	0,5 mm			mm			mm			mm			mm		
R	31.324.132.01-2	45°	28°	-	-	-	-	-	-	-	-	-	-	-	-
NR	31.314.132.01-2			-	-	-	-	-	-	-	-	-	-	-	-

DYNAMIC 3TIBASE®				
	GINGIVAL HEIGHT	α_s	α_s	α_s
		CH=5mm	CH=7mm	CH=9mm
R	-	-	-	-
NR	-	-	-	-

DYNAMIC μ SCANBODY (LAB/CLIN)				DIGITAL ANALOG
SCANBODY	HEIGHT mm	ADAPTOR	SCREWDRIVER ADAPTOR	DIGITAL ANALOG
-	-	-	-	-
-	-	-	-	-

DYNAMIC MILLING TOOL		
DYNAMIC MILLING TOOL	SHANK	α_{di}
33.345.856.01-2	3	25°
33.445.856.01-2	4	
33.645.856.01-2	6	

DYNAMIC SCREWS			
DYNAMIC SCREW	HIGH DYNAMIC SCREW	DYNAMIC SCREWDRIVER	SCREWDRIVER LENGTH (mm)
41.316.081.01-2	-	43.618.201.01-2	18
		43.624.201.01-2	24
		43.632.201.01-2	32

STRAIGHT SCREWS	
STRAIGHT SCREW	SCREWDRIVER Hex. 1.27
40.316.005.08-2	43.601.105.01-2

ANALOG	LAB SCANBODY
-	30.414.003.01-2

LIBRARY OPTIONS

GH = Gingival Height
CH = Cement Height
IG = Adaptor 3mm

α_s = Standard maximum angulation
 α_c = Captive maximum angulation
 α_{di} = Direct to implant maximum angulation
 α_{dp} = Dynamic Premilled maximum angulation

R = Rotational / Non-Engaging
NR = Non Rotational / Engaging

STANDARD DYNAMIC TIBASE®															
	GINGIVAL HEIGHT	α_s	α_c	GINGIVAL HEIGHT	α_s	α_c	GINGIVAL HEIGHT	α_s	α_c	GINGIVAL HEIGHT	α_s	α_c	GINGIVAL HEIGHT	α_s	α_c
	1 mm			mm			mm			mm			mm		
R	31.320.135.01-2	45°	-	-	-	-	-	-	-	-	-	-	-	-	-
NR	31.310.135.01-2			-	-	-	-	-	-	-	-	-	-	-	-

DYNAMIC 3TIBASE®				
	GINGIVAL HEIGHT	α_s	α_s	α_s
		CH=5mm	CH=7mm	CH=9mm
R	-	-	-	-
NR	-	-	-	-

DYNAMIC μ SCANBODY (LAB/CLIN)				DIGITAL ANALOG
SCANBODY	HEIGHT mm	ADAPTOR	SCREWDRIVER ADAPTOR	DIGITAL ANALOG
-	-	-	-	-
-	-	-	-	-

DYNAMIC MILLING TOOL		
DYNAMIC MILLING TOOL	SHANK	α_{di}
-	-	-
-	-	-

DYNAMIC SCREWS			
DYNAMIC SCREW	HIGH DYNAMIC SCREW	DYNAMIC SCREWDRIVER	SCREWDRIVER LENGTH (mm)
41.314.080.01-2	-	43.618.201.01-2	18
		43.624.201.01-2	24
		43.632.201.01-2	32

STRAIGHT SCREWS	
STRAIGHT SCREW	SCREWDRIVER TORX T6
40.314.007.02-2	43.601.107.01-2

ANALOG	LAB SCANBODY
-	30.410.006.01-2

LIBRARY OPTIONS

GH = Gingival Height
CH = Cement Height
IG = Adaptor 3mm

α_s = Standard maximum angulation
 α_c = Captive maximum angulation
 α_{di} = Direct to implant maximum angulation
 α_{dp} = Dynamic Premilled maximum angulation

R = Rotational / Non-Engaging
NR = Non Rotational / Engaging

COMPATIBLE with 0136

STANDARD DYNAMIC TIBASE®																		
	GINGIVAL HEIGHT	α_s	α_c	GINGIVAL HEIGHT	α_s	α_c	GINGIVAL HEIGHT	α_s	α_c	GINGIVAL HEIGHT	α_s	α_c	GINGIVAL HEIGHT	α_s	α_c			
	0,7 mm			1,5 mm			mm			3 mm			4 mm			5 mm		
R	31.320.136.01-2	45°	30°	31.320.136.02-2	25°	-	-	-	-	31.320.136.04-2	20°	-	31.320.136.05-2	20°	-	31.320.136.06-2	15°	-
NR	31.310.136.01-2			31.310.136.02-2						31.310.136.04-2			31.310.136.05-2			31.310.136.06-2		

DYNAMIC 3TIBASE®				
GINGIVAL HEIGHT	α_s	α_s	α_s	
	CH=5mm	CH= 7mm	CH= 9mm	
-	-	-	-	-
-	-	-	-	-

DYNAMIC μ SCANBODY (LAB/CLIN)				DIGITAL ANALOG
SCANBODY	HEIGHT mm	ADAPTOR	SCREWDRIVER ADAPTOR	DIGITAL ANALOG
52.410.128.01-2	10	50.310.136.01-2	43.621.415.01-2	34.610.136.01-2
		50.310.136.04-2		
52.412.128.01-2	12	IG=3mm		

DYNAMIC MILLING TOOL		
DYNAMIC MILLING TOOL	SHANK	α_{di}
33.360.754.01-2	3	25°
33.460.754.01-2	4	
33.660.754.01-2	6	

DYNAMIC SCREWS			
DYNAMIC SCREW	HIGH DYNAMIC SCREW	DYNAMIC SCREWDRIVER	SCREWDRIVER LENGTH (mm)
41.316.071.01-2	-	43.618.201.01-2	18
		43.624.201.01-2	24
		43.632.201.01-2	32

STRAIGHT SCREWS	
STRAIGHT SCREW	SCREWDRIVER Hex. 1.25
40.316.004.03-2	43.601.104.01-2

ANALOG	LAB SCANBODY
-	30.410.006.01-2

MULTI-UNIT				
	GINGIVAL HEIGHT	GINGIVAL HEIGHT	GINGIVAL HEIGHT	GINGIVAL HEIGHT
	1 mm	2 mm	3 mm	4 mm
R	42.300.136.01-2	42.300.136.02-2	42.300.136.3-2	42.300.136.04-2

LIBRARY OPTIONS
GH = Gingival Height
CH = Cement Height
IG = Adaptor 3mm
 α_s = Standard maximum angulation
 α_c = Captive maximum angulation
 α_{di} = Direct to implant maximum angulation
 α_{dp} = Dynamic Premilled maximum angulation
R = Rotational / Non-Engaging
NR = Non Rotational / Engaging

COMPATIBLE with 0137

STANDARD DYNAMIC TIBASE®															
	GINGIVAL HEIGHT	α_s	α_c	GINGIVAL HEIGHT	α_s	α_c	GINGIVAL HEIGHT	α_s	α_c	GINGIVAL HEIGHT	α_s	α_c	GINGIVAL HEIGHT	α_s	α_c
	0,6 mm			mm			mm			mm			mm		
R	31.324.137.01-2	45°	30°	-	-	-	-	-	-	-	-	-	-	-	-
NR	31.314.137.01-2			-			-			-			-		

DYNAMIC 3TIBASE®				
GINGIVAL HEIGHT	α_s	α_s	α_s	
	CH=5mm	CH= 7mm	CH= 9mm	
-	-	-	-	-
-	-	-	-	-

DYNAMIC μ SCANBODY (LAB/CLIN)				DIGITAL ANALOG
SCANBODY	HEIGHT mm	ADAPTOR	SCREWDRIVER ADAPTOR	DIGITAL ANALOG
-	-	-	-	-
-	-			
-	-			

DYNAMIC MILLING TOOL		
DYNAMIC MILLING TOOL	SHANK	α_{di}
-	-	-
-	-	
-	-	

DYNAMIC SCREWS			
DYNAMIC SCREW	HIGH DYNAMIC SCREW	DYNAMIC SCREWDRIVER	SCREWDRIVER LENGTH (mm)
41.320.044.01-2	-	43.618.201.01-2	18
		43.624.201.01-2	24
		43.632.201.01-2	32

STRAIGHT SCREWS	
STRAIGHT SCREW	SCREWDRIVER TORX T6
40.320.007.04-2	43.601.107.01-2

ANALOG	LAB SCANBODY
-	30.414.008.01-2

LIBRARY OPTIONS
GH = Gingival Height
CH = Cement Height
IG = Adaptor 3mm
 α_s = Standard maximum angulation
 α_c = Captive maximum angulation
 α_{di} = Direct to implant maximum angulation
 α_{dp} = Dynamic Premilled maximum angulation
R = Rotational / Non-Engaging
NR = Non Rotational / Engaging

STANDARD DYNAMIC TIBASE®															
GINGIVAL HEIGHT		α_s	α_c	GINGIVAL HEIGHT		α_s	α_c	GINGIVAL HEIGHT		α_s	α_c	GINGIVAL HEIGHT		α_s	α_c
1,5 mm				mm				mm				mm			
R	31.320.145.01-2	45°	-	-	-	-	-	-	-	-	-	-	-	-	-
NR	31.310.145.01-2		-	-	-	-	-	-	-	-	-	-	-	-	-

DYNAMIC 3TIBASE®				
GINGIVAL HEIGHT		α_s	α_s	α_s
		CH=5mm	CH= 7mm	CH= 9mm
-	-	-	-	-
-	-	-	-	-

DYNAMIC μ SCANBODY (LAB/CLIN)				DIGITAL ANALOG
SCANBODY	HEIGHT mm	ADAPTOR	SCREWDRIVER ADAPTOR	DIGITAL ANALOG
-	-	-	-	-
-	-	-	-	-

DYNAMIC MILLING TOOL		
DYNAMIC MILLING TOOL	SHANK	α_{di}
-	-	-
-	-	-
-	-	-

DYNAMIC SCREWS			
DYNAMIC SCREW	HIGH DYNAMIC SCREW	DYNAMIC SCREWDRIVER	SCREWDRIVER LENGTH (mm)
41.315.078.01-2	-	43.618.201.01-2	18
		43.624.201.01-2	24
		43.632.201.01-2	32

STRAIGHT SCREWS	
STRAIGHT SCREW	SCREWDRIVER
-	-

ANALOG	LAB SCANBODY
-	30.410.006.01-2

LIBRARY OPTIONS

GH = Gingival Height
CH = Cement Height
IG = Adaptor 3mm

α_s = Standard maximum angulation
 α_c = Captive maximum angulation
 α_{di} = Direct to implant maximum angulation
 α_{dp} = Dynamic Premilled maximum angulation

R = Rotational / Non-Engaging
NR = Non Rotational / Engaging

STANDARD DYNAMIC TIBASE®															
GINGIVAL HEIGHT		α_s	α_c	GINGIVAL HEIGHT		α_s	α_c	GINGIVAL HEIGHT		α_s	α_c	GINGIVAL HEIGHT		α_s	α_c
1,5 mm				mm				mm				mm			
R	31.323.149.01-2	45°	29°	-	-	-	-	-	-	-	-	-	-	-	-
NR	31.313.149.01-2			-	-	-	-	-	-	-	-	-	-	-	-

DYNAMIC 3TIBASE®				
GINGIVAL HEIGHT		α_s	α_s	α_s
		CH=5mm	CH= 7mm	CH= 9mm
-	-	-	-	-
-	-	-	-	-

DYNAMIC μ SCANBODY (LAB/CLIN)				DIGITAL ANALOG
SCANBODY	HEIGHT mm	ADAPTOR	SCREWDRIVER ADAPTOR	DIGITAL ANALOG
52.410.132.01-2	10	50.310.161.01-2	43.621.410.01-2	34.610.161.01-2
			43.624.410.01-2	
52.412.132.01-2	12			

DYNAMIC MILLING TOOL		
DYNAMIC MILLING TOOL	SHANK	α_{di}
33.320.704.01-2*	3	25°
33.420.704.01-2*	4	
33.620.704.01-2*	6	

*Only for R

DYNAMIC SCREWS			
DYNAMIC SCREW	HIGH DYNAMIC SCREW	DYNAMIC SCREWDRIVER	SCREWDRIVER LENGTH (mm)
41.316.079.01-2	-	43.618.201.01-2	18
		43.624.201.01-2	24
		43.632.201.01-2	32

STRAIGHT SCREWS	
STRAIGHT SCREW	SCREWDRIVER
40.316.014.01-2	-

ANALOG	LAB SCANBODY
-	30.413.002.01-2

LIBRARY OPTIONS

GH = Gingival Height
CH = Cement Height
IG = Adaptor 3mm

α_s = Standard maximum angulation
 α_c = Captive maximum angulation
 α_{di} = Direct to implant maximum angulation
 α_{dp} = Dynamic Premilled maximum angulation

R = Rotational / Non-Engaging
NR = Non Rotational / Engaging

STANDARD DYNAMIC TIBASE®															
	GINGIVAL HEIGHT	α_s	α_c	GINGIVAL HEIGHT	α_s	α_c	GINGIVAL HEIGHT	α_s	α_c	GINGIVAL HEIGHT	α_s	α_c	GINGIVAL HEIGHT	α_s	α_c
	0,5 mm			mm			mm			mm			mm		
R	31.323.150.01-2	45°	-	-	-	-	-	-	-	-	-	-	-	-	-
NR	-			-			-			-			-		

DYNAMIC 3TIBASE®				
GINGIVAL HEIGHT	α_s	α_s	α_s	
	CH=5mm	CH=7mm	CH=9mm	
-	-	-	-	-
-	-	-	-	-

DYNAMIC μSCANBODY (LAB/CLIN)				DIGITAL ANALOG
SCANBODY	HEIGHT mm	ADAPTOR	SCREWDRIVER ADAPTOR	DIGITAL ANALOG
-	-	-	-	-
-	-	-	-	-

DYNAMIC MILLING TOOL		
DYNAMIC MILLING TOOL	SHANK	α_{di}
-	-	-
-	-	-

DYNAMIC SCREWS			
DYNAMIC SCREW	HIGH DYNAMIC SCREW	DYNAMIC SCREWDRIVER	SCREWDRIVER LENGTH (mm)
41.314.046.01-2	-	43.618.201.01-2	18
		43.624.201.01-2	24
		43.632.201.01-2	32

STRAIGHT SCREWS	
STRAIGHT SCREW	SCREWDRIVER Hex. 1.25
40.314.004.04-2	43.601.104.01-2

ANALOG	LAB SCANBODY
-	30.413.005.01-2

LIBRARY OPTIONS

GH = Gingival Height
CH = Cement Height
IG = Adaptor 3mm
 α_s = Standard maximum angulation
 α_c = Captive maximum angulation
 α_{di} = Direct to implant maximum angulation
 α_{dp} = Dynamic Premilled maximum angulation

R = Rotational / Non-Engaging
NR = Non Rotational / Engaging

STANDARD DYNAMIC TIBASE®															
	GINGIVAL HEIGHT	α_s	α_c	GINGIVAL HEIGHT	α_s	α_c	GINGIVAL HEIGHT	α_s	α_c	GINGIVAL HEIGHT	α_s	α_c	GINGIVAL HEIGHT	α_s	α_c
	0,3 mm			mm			mm			mm			mm		
R	31.323.151.01-2	45°	30°	-	-	-	-	-	-	-	-	-	-	-	-
-	-			-			-			-			-		

DYNAMIC 3TIBASE®				
GINGIVAL HEIGHT	α_s	α_s	α_s	
	CH=5mm	CH=7mm	CH=9mm	
-	-	-	-	-
-	-	-	-	-

DYNAMIC μSCANBODY (LAB/CLIN)				DIGITAL ANALOG
SCANBODY	HEIGHT mm	ADAPTOR	SCREWDRIVER ADAPTOR	DIGITAL ANALOG
52.409.123.01-2	9	50.313.151.01-2	43.621.410.01-2 43.624.410.01-2	34.613.151.01-2

DYNAMIC MILLING TOOL		
DYNAMIC MILLING TOOL	SHANK	α_{di}
33.390.716.01-2	3	30°
33.490.716.01-2	4	
33.690.716.01-2	6	

DYNAMIC SCREWS			
DYNAMIC SCREW	HIGH DYNAMIC SCREW	DYNAMIC SCREWDRIVER	SCREWDRIVER LENGTH (mm)
41.314.039.01-2	-	43.618.201.01-2	18
		43.624.201.01-2	24
		43.632.201.01-2	32

STRAIGHT SCREWS	
STRAIGHT SCREW	SCREWDRIVER Unigrip
40.314.008.01-2	43.625.108.01-2

ANALOG	LAB SCANBODY
-	-

LIBRARY OPTIONS

GH = Gingival Height
CH = Cement Height
IG = Adaptor 3mm
 α_s = Standard maximum angulation
 α_c = Captive maximum angulation
 α_{di} = Direct to implant maximum angulation
 α_{dp} = Dynamic Premilled maximum angulation

R = Rotational / Non-Engaging
NR = Non Rotational / Engaging

STANDARD DYNAMIC TIBASE®															
	GINGIVAL HEIGHT	α_s	α_c	GINGIVAL HEIGHT	α_s	α_c	GINGIVAL HEIGHT	α_s	α_c	GINGIVAL HEIGHT	α_s	α_c	GINGIVAL HEIGHT	α_s	α_c
	1 mm			2 mm			3 mm			4 mm			mm		
R	31.320.152.01-2	45°	-	31.320.152.02-2	25°	-	31.320.152.03-2	20°	-	31.320.152.04-2	20°	-	-	-	-
NR	31.310.152.01-2			31.310.152.02-2			31.310.152.03-2			31.310.152.04-2			-	-	-

DYNAMIC 3TIBASE®				
GINGIVAL HEIGHT	α_s	α_s	α_s	
	CH=5mm	CH=7mm	CH=9mm	
-	-	-	-	-
-	-	-	-	-

DYNAMIC μ SCANBODY (LAB/CLIN)				DIGITAL ANALOG
SCANBODY	HEIGHT mm	ADAPTOR	SCREWDRIVER ADAPTOR	DIGITAL ANALOG
52.410.104.01-2	10	50.310.152.03-2 IG=3mm	43.621.410.01-2 43.624.410.01-2	34.610.152.01-2
52.412.104.01-2	12			

DYNAMIC MILLING TOOL		
DYNAMIC MILLING TOOL	SHANK	α_{di}
33.360.756.01-2	3	25°
33.460.756.01-2	4	
33.660.756.01-2	6	

*Only for R

DYNAMIC SCREWS			
DYNAMIC SCREW	HIGH DYNAMIC SCREW	DYNAMIC SCREWDRIVER	SCREWDRIVER LENGTH (mm)
41.318.077.02-2	-	43.618.201.01-2	18
		43.624.201.01-2	24
		43.632.201.01-2	32

STRAIGHT SCREWS	
STRAIGHT SCREW	SCREWDRIVER
-	-

ANALOG	LAB SCANBODY
-	30.410.006.01-2

MULTI-UNIT				
	GINGIVAL HEIGHT	GINGIVAL HEIGHT	GINGIVAL HEIGHT	GINGIVAL HEIGHT
	1 mm	2 mm	3 mm	4 mm
R	-	42.300.152.02-2	42.300.152.03-2	-

LIBRARY OPTIONS

GH = Gingival Height
 CH = Cement Height
 IG = Adaptor 3mm
 α_s = Standard maximum angulation
 α_c = Captive maximum angulation
 α_{di} = Direct to implant maximum angulation
 α_{dp} = Dynamic Premilled maximum angulation

R = Rotational / Non-Engaging
 NR = Non Rotational / Engaging

STANDARD DYNAMIC TIBASE®															
	GINGIVAL HEIGHT	α_s	α_c	GINGIVAL HEIGHT	α_s	α_c	GINGIVAL HEIGHT	α_s	α_c	GINGIVAL HEIGHT	α_s	α_c	GINGIVAL HEIGHT	α_s	α_c
	1,5 mm			mm			mm			mm			mm		
R	31.320.159.01-2	41°	17°	-	-	-	-	-	-	-	-	-	-	-	-
NR	31.310.159.01-2			-	-	-	-	-	-	-	-	-	-	-	-

DYNAMIC 3TIBASE®				
GINGIVAL HEIGHT	α_s	α_s	α_s	
	CH=5mm	CH=7mm	CH=9mm	
-	-	-	-	-
-	-	-	-	-

DYNAMIC μ SCANBODY (LAB/CLIN)				DIGITAL ANALOG
SCANBODY	HEIGHT mm	ADAPTOR	SCREWDRIVER ADAPTOR	DIGITAL ANALOG
52.410.128.01-2	10	50.310.159.01-2	43.621.415.01-2	34.610.159.01-2
-	-			

DYNAMIC MILLING TOOL		
DYNAMIC MILLING TOOL	SHANK	α_{di}
33.335.754.01-2*	3	25°
33.435.754.01-2*	4	
33.635.754.01-2*	6	

*Only for R

DYNAMIC SCREWS			
DYNAMIC SCREW	HIGH DYNAMIC SCREW	DYNAMIC SCREWDRIVER	SCREWDRIVER LENGTH (mm)
41.314.067.02-2	-	43.618.201.01-2	18
		43.624.201.01-2	24
		43.632.201.01-2	32

STRAIGHT SCREWS	
STRAIGHT SCREW	SCREWDRIVER UNIGRIP
40.314.008.02-2	43.601.108.01-2

ANALOG	LAB SCANBODY
22.610.159.01-2	30.410.006.01-2

MULTI-UNIT				
	GINGIVAL HEIGHT	GINGIVAL HEIGHT	GINGIVAL HEIGHT	GINGIVAL HEIGHT
	1 mm	2 mm	3 mm	4 mm
R	42.300.159.01-2	42.300.159.02-2	42.300.159.03-2	42.300.159.04-2

LIBRARY OPTIONS

GH = Gingival Height
 CH = Cement Height
 IG = Adaptor 3mm
 α_s = Standard maximum angulation
 α_c = Captive maximum angulation
 α_{di} = Direct to implant maximum angulation
 α_{dp} = Dynamic Premilled maximum angulation

R = Rotational / Non-Engaging
 NR = Non Rotational / Engaging

STANDARD DYNAMIC TIBASE®															
	GINGIVAL HEIGHT	α_s	α_c	GINGIVAL HEIGHT	α_s	α_c	GINGIVAL HEIGHT	α_s	α_c	GINGIVAL HEIGHT	α_s	α_c	GINGIVAL HEIGHT	α_s	α_c
	0,5 mm			mm			mm			mm			mm		
R	31.320.160.01-2	45°	30°	-	-	-	-	-	-	-	-	-	-	-	-
NR	31.310.160.01-2			-	-	-	-	-	-	-	-	-	-	-	-

DYNAMIC 3TIBASE®				
GINGIVAL HEIGHT	α_s	α_s	α_s	
	CH=5mm	CH= 7mm	CH= 9mm	
-	-	-	-	-
-	-	-	-	-

DYNAMIC μSCANBODY (LAB/CLIN)				DIGITAL ANALOG
SCANBODY	HEIGHT mm	ADAPTOR	SCREWDRIVER ADAPTOR	DIGITAL ANALOG
52.410.131.01-2	10	50.310.160.01-2	43.621.415.01-2	34.610.160.01-2
52.412.131.01-2	12			

DYNAMIC MILLING TOOL			SCANALOG
DYNAMIC MILLING TOOL	SHANK	α_{di}	
33.315.804.01-2	3	25°	23.410.160.01-2
33.415.804.01-2	4		
33.615.804.01-2	6		

DYNAMIC SCREWS			
DYNAMIC SCREW	HIGH DYNAMIC SCREW	DYNAMIC SCREWDRIVER	SCREWDRIVER LENGTH (mm)
41.316.078.01-2	-	43.618.201.01-2	18
		43.624.201.01-2	24
		43.632.201.01-2	32

STRAIGHT SCREWS	
STRAIGHT SCREW	SCREWDRIVER TORX T6
40.316.007.01-2	43.601.107.01-2

ANALOG	LAB SCANBODY
22.610.160.01-2	30.410.006.01-2

LIBRARY OPTIONS
GH = Gingival Height
CH = Cement Height
IG = Adaptor 3mm
 α_s = Standard maximum angulation
 α_c = Captive maximum angulation
 α_{di} = Direct to implant maximum angulation
 α_{dp} = Dynamic Premilled maximum angulation
R = Rotational / Non-Engaging
NR = Non Rotational / Engaging

STANDARD DYNAMIC TIBASE®															
	GINGIVAL HEIGHT	α_s	α_c	GINGIVAL HEIGHT	α_s	α_c	GINGIVAL HEIGHT	α_s	α_c	GINGIVAL HEIGHT	α_s	α_c	GINGIVAL HEIGHT	α_s	α_c
	1,5 mm			mm			mm			mm			mm		
R	31.320.161.01-2	45°	25°	-	-	-	-	-	-	-	-	-	-	-	-
NR	31.310.161.01-2			-	-	-	-	-	-	-	-	-	-	-	-

DYNAMIC 3TIBASE®				
GINGIVAL HEIGHT	α_s	α_s	α_s	
	CH=5mm	CH= 7mm	CH= 9mm	
-	-	-	-	-
-	-	-	-	-

DYNAMIC μSCANBODY (LAB/CLIN)				DIGITAL ANALOG
SCANBODY	HEIGHT mm	ADAPTOR	SCREWDRIVER ADAPTOR	DIGITAL ANALOG
52.410.132.01-2	10	50.310.161.01-2	43.621.415.01-2	34.610.161.01-2
52.412.132.01-2	12			

DYNAMIC MILLING TOOL			α_{di}
DYNAMIC MILLING TOOL	SHANK	α_{di}	
33.320.704.01-2*	3	25°	
33.420.704.01-2*	4		
33.620.704.01-2*	6		

*Only for R

DYNAMIC SCREWS			
DYNAMIC SCREW	HIGH DYNAMIC SCREW	DYNAMIC SCREWDRIVER	SCREWDRIVER LENGTH (mm)
41.316.079.01-2	-	43.618.201.01-2	18
		43.624.201.01-2	24
		43.632.201.01-2	32

STRAIGHT SCREWS	
STRAIGHT SCREW	SCREWDRIVER
40.316.014.01-2	-

ANALOG	LAB SCANBODY
-	30.410.006.01-2

LIBRARY OPTIONS
GH = Gingival Height
CH = Cement Height
IG = Adaptor 3mm
 α_s = Standard maximum angulation
 α_c = Captive maximum angulation
 α_{di} = Direct to implant maximum angulation
 α_{dp} = Dynamic Premilled maximum angulation
R = Rotational / Non-Engaging
NR = Non Rotational / Engaging

STANDARD DYNAMIC TIBASE®															
	GINGIVAL HEIGHT	α_s	α_c	GINGIVAL HEIGHT	α_s	α_c	GINGIVAL HEIGHT	α_s	α_c	GINGIVAL HEIGHT	α_s	α_c	GINGIVAL HEIGHT	α_s	α_c
	1,5 mm			mm			mm			mm			mm		
R	31.324.162.01-2	45°	24°	-	-	-	-	-	-	-	-	-	-	-	-
NR	31.314.162.01-2			-	-	-	-	-	-	-	-	-	-	-	-

DYNAMIC 3TIBASE®				
GINGIVAL HEIGHT	α_s	α_s	α_s	
	CH=5mm	CH=7mm	CH=9mm	
-	-	-	-	-
-	-	-	-	-

DYNAMIC μ SCANBODY (LAB/CLIN)				DIGITAL ANALOG
SCANBODY	HEIGHT mm	ADAPTOR	SCREWDRIVER ADAPTOR	DIGITAL ANALOG
52.410.132.01-2	10	50.310.161.01-2	43.621.415.01-2	34.610.161.01-2
52.412.132.01-2	12			

DYNAMIC MILLING TOOL			
DYNAMIC MILLING TOOL	SHANK	α_{di}	
33.320.704.01-2*	3	25°	
33.420.704.01-2*	4		
33.620.704.01-2*	6		

*Only for R

DYNAMIC SCREWS			
DYNAMIC SCREW	HIGH DYNAMIC SCREW	DYNAMIC SCREWDRIVER	SCREWDRIVER LENGTH (mm)
41.316.079.01-2	-	43.618.201.01-2	18
		43.624.201.01-2	24
		43.632.201.01-2	32

STRAIGHT SCREWS	
STRAIGHT SCREW	SCREWDRIVER
40.316.014.01-2	-

ANALOG	LAB SCANBODY
-	30.414.003.01-2

LIBRARY OPTIONS

GH = Gingival Height
CH = Cement Height
IG = Adaptor 3mm

α_s = Standard maximum angulation
 α_c = Captive maximum angulation
 α_{di} = Direct to implant maximum angulation
 α_{dp} = Dynamic Premilled maximum angulation

R = Rotational / Non-Engaging
NR = Non Rotational / Engaging

STANDARD DYNAMIC TIBASE®															
	GINGIVAL HEIGHT	α_s	α_c	GINGIVAL HEIGHT	α_s	α_c	GINGIVAL HEIGHT	α_s	α_c	GINGIVAL HEIGHT	α_s	α_c	GINGIVAL HEIGHT	α_s	α_c
	0,5 mm			mm			mm			mm			mm		
R	31.323.163.01-2	45°	30°	-	-	-	-	-	-	-	-	-	-	-	-
NR	-			-	-	-	-	-	-	-	-	-	-	-	-

DYNAMIC 3TIBASE®				
GINGIVAL HEIGHT	α_s	α_s	α_s	
	CH=5mm	CH=7mm	CH=9mm	
-	-	-	-	-
-	-	-	-	-

DYNAMIC μ SCANBODY (LAB/CLIN)				DIGITAL ANALOG
SCANBODY	HEIGHT mm	ADAPTOR	SCREWDRIVER ADAPTOR	DIGITAL ANALOG
52.408.112.01-2	8	50.313.163.01-2	43.620.411.01-2	34.613.163.01-2

DYNAMIC MILLING TOOL		
DYNAMIC MILLING TOOL	SHANK	α_{di}
33.390.716.01-2	3	30°
33.490.716.01-2	4	
33.690.716.01-2	6	

DYNAMIC SCREWS			
DYNAMIC SCREW	HIGH DYNAMIC SCREW	DYNAMIC SCREWDRIVER	SCREWDRIVER LENGTH (mm)
41.314.039.01-2	-	43.618.201.01-2	18
		43.624.201.01-2	24
		43.632.201.01-2	32

STRAIGHT SCREWS	
STRAIGHT SCREW	SCREWDRIVER
40.314.014.01-2	-

ANALOG	LAB SCANBODY
-	30.413.005.01-2

LIBRARY OPTIONS

GH = Gingival Height
CH = Cement Height
IG = Adaptor 3mm

α_s = Standard maximum angulation
 α_c = Captive maximum angulation
 α_{di} = Direct to implant maximum angulation
 α_{dp} = Dynamic Premilled maximum angulation

R = Rotational / Non-Engaging
NR = Non Rotational / Engaging

STANDARD DYNAMIC TIBASE®															
	GINGIVAL HEIGHT	α_s	α_c	GINGIVAL HEIGHT	α_s	α_c	GINGIVAL HEIGHT	α_s	α_c	GINGIVAL HEIGHT	α_s	α_c	GINGIVAL HEIGHT	α_s	α_c
	1,5 mm			mm			mm			mm			mm		
R	31.320.164.01-2	45°	21°	-	-	-	-	-	-	-	-	-	-	-	-
NR	31.310.164.01-2			-	-	-	-	-	-	-	-	-	-	-	-

DYNAMIC 3TIBASE®				
GINGIVAL HEIGHT	α_s	α_s	α_s	
	CH=5mm	CH=7mm	CH=9mm	
-	-	-	-	-
-	-	-	-	-

DYNAMIC μ SCANBODY (LAB/CLIN)				DIGITAL ANALOG
SCANBODY	HEIGHT mm	ADAPTOR	SCREWDRIVER ADAPTOR	DIGITAL ANALOG
52.410.128.01-2	10	50.310.164.01-2	43.621.415.01-2	34.610.164.01-2
52.412.128.01-2	12			

DYNAMIC MILLING TOOL			
DYNAMIC MILLING TOOL	SHANK	α_{di}	
33.345.804.01-2*	3	25°	
33.445.804.01-2*	4		
33.645.804.01-2*	6		

*Only for R

DYNAMIC SCREWS				STRAIGHT SCREWS		ANALOG		LAB SCANBODY	
DYNAMIC SCREW	HIGH DYNAMIC SCREW	DYNAMIC SCREWDRIVER	SCREWDRIVER LENGTH (mm)	STRAIGHT SCREW	SCREWDRIVER Hex. 1,20				
41.312.078.01-2	-	43.618.201.01-2	18	40.312.003.01-2	43.601.103.02-2	-	-	-	30.410.006.01-2
		43.624.201.01-2	24						
		43.632.201.01-2	32						

LIBRARY OPTIONS
GH = Gingival Height
CH = Cement Height
IG = Adaptor 3mm
 α_s = Standard maximum angulation
 α_c = Captive maximum angulation
 α_{di} = Direct to implant maximum angulation
 α_{dp} = Dynamic Premilled maximum angulation
R = Rotational / Non-Engaging
NR = Non Rotational / Engaging

STANDARD DYNAMIC TIBASE®															
	GINGIVAL HEIGHT	α_s	α_c	GINGIVAL HEIGHT	α_s	α_c	GINGIVAL HEIGHT	α_s	α_c	GINGIVAL HEIGHT	α_s	α_c	GINGIVAL HEIGHT	α_s	α_c
	1 mm			mm			mm			mm			mm		
R	31.323.165.01-2	45°	25°	-	-	-	-	-	-	-	-	-	-	-	-
NR	31.313.165.01-2			-	-	-	-	-	-	-	-	-	-	-	-

DYNAMIC 3TIBASE®				
GINGIVAL HEIGHT	α_s	α_s	α_s	
	CH=5mm	CH=7mm	CH=9mm	
-	-	-	-	-
-	-	-	-	-

DYNAMIC μ SCANBODY (LAB/CLIN)				DIGITAL ANALOG
SCANBODY	HEIGHT mm	ADAPTOR	SCREWDRIVER ADAPTOR	DIGITAL ANALOG
52.410.132.01-2	10	50.313.165.01-2	43.621.415.01-2	34.613.165.01-2
52.412.132.01-2	12			

DYNAMIC MILLING TOOL			
DYNAMIC MILLING TOOL	SHANK	α_{di}	
33.345.804.01-2*	3	30°	
33.445.804.01-2*	4		
33.645.804.01-2*	6		

*Only for R

DYNAMIC SCREWS				STRAIGHT SCREWS		ANALOG		LAB SCANBODY	
DYNAMIC SCREW	HIGH DYNAMIC SCREW	DYNAMIC SCREWDRIVER	SCREWDRIVER LENGTH (mm)	STRAIGHT SCREW	SCREWDRIVER Hex. 1.20				
41.314.076.01-2	-	43.618.201.01-2	18	40.314.003.03-2	43.601.103.02-2	-	-	-	30.413.002.01-2
		43.624.201.01-2	24						
		43.632.201.01-2	32						

LIBRARY OPTIONS
GH = Gingival Height
CH = Cement Height
IG = Adaptor 3mm
 α_s = Standard maximum angulation
 α_c = Captive maximum angulation
 α_{di} = Direct to implant maximum angulation
 α_{dp} = Dynamic Premilled maximum angulation
R = Rotational / Non-Engaging
NR = Non Rotational / Engaging

STANDARD DYNAMIC TIBASE®															
	GINGIVAL HEIGHT	α_s	α_c	GINGIVAL HEIGHT	α_s	α_c	GINGIVAL HEIGHT	α_s	α_c	GINGIVAL HEIGHT	α_s	α_c	GINGIVAL HEIGHT	α_s	α_c
	0,9 mm			mm			mm			mm			mm		
R	31.320.166.01-2	45°	30°	-	-	-	-	-	-	-	-	-	-	-	-
NR	31.310.166.01-2			-	-	-	-	-	-	-	-	-	-	-	-

DYNAMIC 3TIBASE®				
GINGIVAL HEIGHT	α_s	α_s	α_s	
	CH=5mm	CH= 7mm	CH= 9mm	
-	-	-	-	-
-	-	-	-	-

DYNAMIC μ SCANBODY (LAB/CLIN)				DIGITAL ANALOG
SCANBODY	HEIGHT mm	ADAPTOR	SCREWDRIVER ADAPTOR	DIGITAL ANALOG
52.410.128.01-2	10	50.310.166.03-2 IG=3mm	43.621.415.01-2	34.610.166.01-2
-	-			
-	-			

DYNAMIC MILLING TOOL			
DYNAMIC MILLING TOOL	SHANK	α_{di}	
33.330.734.01-2	3	20°	
33.430.734.01-2	4		
33.630.734.01-2	6		

DYNAMIC SCREWS			
DYNAMIC SCREW	HIGH DYNAMIC SCREW	DYNAMIC SCREWDRIVER	SCREWDRIVER LENGTH (mm)
41.314.084.01-2	-	43.618.201.01-2	18
		43.624.201.01-2	24
		43.632.201.01-2	32

STRAIGHT SCREWS	
STRAIGHT SCREW	SCREWDRIVER Hex. 1.25
40.314.004.02-2	43.601.104.01-2

ANALOG	LAB SCANBODY
-	30.410.006.01-2

LIBRARY OPTIONS

GH = Gingival Height
CH = Cement Height
IG = Adaptor 3mm

α_s = Standard maximum angulation
 α_c = Captive maximum angulation
 α_{di} = Direct to implant maximum angulation
 α_{dp} = Dynamic Premilled maximum angulation

R = Rotational / Non-Engaging
NR = Non Rotational / Engaging

STANDARD DYNAMIC TIBASE®															
	GINGIVAL HEIGHT	α_s	α_c	GINGIVAL HEIGHT	α_s	α_c	GINGIVAL HEIGHT	α_s	α_c	GINGIVAL HEIGHT	α_s	α_c	GINGIVAL HEIGHT	α_s	α_c
	0,9 mm			mm			mm			mm			mm		
R	31.322.167.01-2	43°	30°	-	-	-	-	-	-	-	-	-	-	-	-
NR	31.312.167.01-2			-	-	-	-	-	-	-	-	-	-	-	-

DYNAMIC 3TIBASE®				
GINGIVAL HEIGHT	α_s	α_s	α_s	
	CH=5mm	CH= 7mm	CH= 9mm	
-	-	-	-	-
-	-	-	-	-

DYNAMIC μ SCANBODY (LAB/CLIN)				DIGITAL ANALOG
SCANBODY	HEIGHT mm	ADAPTOR	SCREWDRIVER ADAPTOR	DIGITAL ANALOG
52.410.117.01-2	10	50.313.167.03-2 (IG= 3mm)	43.620.411.01-2	34.613.167.01-2
			43.621.410.01-2	
52.412.117.01-2	12		43.624.410.01-2	

DYNAMIC MILLING TOOL		
DYNAMIC MILLING TOOL	SHANK	α_{di}
33.330.734.01-2	3	20°
33.430.734.01-2	4	
33.630.734.01-2	6	

DYNAMIC SCREWS			
DYNAMIC SCREW	HIGH DYNAMIC SCREW	DYNAMIC SCREWDRIVER	SCREWDRIVER LENGTH (mm)
41.316.084.02-2	-	43.618.201.01-2	18
		43.624.201.01-2	24
		43.632.201.01-2	32

STRAIGHT SCREWS	
STRAIGHT SCREW	SCREWDRIVER Hex. 1.25
40.316.004.01-2	43.601.104.01-2

ANALOG	LAB SCANBODY
-	30.412.001.01-2

LIBRARY OPTIONS

GH = Gingival Height
CH = Cement Height
IG = Adaptor 3mm

α_s = Standard maximum angulation
 α_c = Captive maximum angulation
 α_{di} = Direct to implant maximum angulation
 α_{dp} = Dynamic Premilled maximum angulation

R = Rotational / Non-Engaging
NR = Non Rotational / Engaging

STANDARD DYNAMIC TIBASE®															
	GINGIVAL HEIGHT	α_s	α_c	GINGIVAL HEIGHT	α_s	α_c	GINGIVAL HEIGHT	α_s	α_c	GINGIVAL HEIGHT	α_s	α_c	GINGIVAL HEIGHT	α_s	α_c
	0,6 mm			1,5 mm			mm			3 mm			mm		
R	31.322.169.01-2	45°	29°	31.322.169.02-2	25	-	-	-	-	31.322.169.04-2	20	-	-	-	-
NR	31.312.169.01-2			31.312.169.02-2			-	-	31.312.169.04-2	-			-	-	

DYNAMIC 3TIBASE®									
	GINGIVAL HEIGHT	α_s	α_s	α_s	GINGIVAL HEIGHT	α_s	α_s	α_s	
	1,5 mm	CH=5mm	CH=7mm	CH=9mm	3 mm	CH=5mm	CH=7mm	CH=9mm	
R	31.322.169.22-2	30°	25°	15°	31.322.169.24-2	25°	20°	15°	
NR	31.312.169.22-2				31.312.169.24-2				

DYNAMIC μ SCANBODY (LAB/CLIN)					DIGITAL ANALOG		DYNAMIC MILLING TOOL		
SCANBODY	HEIGHT mm	ADAPTOR	SCREWDRIVER ADAPTOR	DIGITAL ANALOG	DYNAMIC MILLING TOOL	SHANK	α_{di}		
52.410.117.01-2	10	50.312.169.01-2	43.621.410.01-2	34.612.169.01-2	33.330.734.01-2	3	25°		
		50.312.169.04-2	43.624.410.01-2		33.430.734.01-2	4			
52.412.117.01-2	12	IG=3mm			33.630.734.01-2	6			

DYNAMIC SCREWS				STRAIGHT SCREWS		ANALOG		LAB SCANBODY	
DYNAMIC SCREW	HIGH DYNAMIC SCREW	DYNAMIC SCREWDRIVER	SCREWDRIVER LENGTH (mm)	STRAIGHT SCREW	SCREWDRIVER				
41.317.070.01-2	-	43.618.201.01-2	18	-	-	-	-	-	30.412.001.01-2
		43.624.201.01-2	24						
		43.632.201.01-2	32						

MULTI-UNIT				
	GINGIVAL HEIGHT	GINGIVAL HEIGHT	GINGIVAL HEIGHT	GINGIVAL HEIGHT
	1 mm	2 mm	3 mm	4 mm
R	42.302.169.01-2	42.302.169.02-2	42.302.169.03-2	42.302.169.04-2

LIBRARY OPTIONS
GH = Gingival Height
CH = Cement Height
IG = Adaptor 3mm
 α_s = Standard maximum angulation
 α_c = Captive maximum angulation
 α_{di} = Direct to implant maximum angulation
 α_{dp} = Dynamic Premilled maximum angulation
R = Rotational / Non-Engaging
NR = Non Rotational / Engaging

STANDARD DYNAMIC TIBASE®															
	GINGIVAL HEIGHT	α_s	α_c	GINGIVAL HEIGHT	α_s	α_c	GINGIVAL HEIGHT	α_s	α_c	GINGIVAL HEIGHT	α_s	α_c	GINGIVAL HEIGHT	α_s	α_c
	0,3 mm			mm			mm			mm			mm		
R	31.322.170.01-2	38°	-	-	-	-	-	-	-	-	-	-	-	-	-
NR	31.312.170.01-2			-			-			-			-		

DYNAMIC 3TIBASE®				
	GINGIVAL HEIGHT	α_s	α_s	α_s
	0,3 mm	CH=5mm	CH=7mm	CH=9mm
R	31.322.170.21-2	30°	20°	15°
NR	31.312.170.21-2			

DYNAMIC μ SCANBODY (LAB/CLIN)					DIGITAL ANALOG		DYNAMIC MILLING TOOL		
SCANBODY	HEIGHT mm	ADAPTOR	SCREWDRIVER ADAPTOR	DIGITAL ANALOG	DYNAMIC MILLING TOOL	SHANK	α_{di}		
-	-				33.390.754.01-2	3	25°		
		-	-	-	33.490.754.01-2	4			
-	-				33.690.754.01-2	6			

DYNAMIC SCREWS				STRAIGHT SCREWS		ANALOG		LAB SCANBODY	
DYNAMIC SCREW	HIGH DYNAMIC SCREW	DYNAMIC SCREWDRIVER	SCREWDRIVER LENGTH (mm)	STRAIGHT SCREW	SCREWDRIVER Hex. 1.20				
41.316.079.02-2	-	43.618.201.01-2	18	-	-	-	-	-	30.410.006.01-2
		43.624.201.01-2	24						
		43.632.201.01-2	32						

LIBRARY OPTIONS
GH = Gingival Height
CH = Cement Height
IG = Adaptor 3mm
 α_s = Standard maximum angulation
 α_c = Captive maximum angulation
 α_{di} = Direct to implant maximum angulation
 α_{dp} = Dynamic Premilled maximum angulation
R = Rotational / Non-Engaging
NR = Non Rotational / Engaging

STANDARD DYNAMIC TIBASE®															
	GINGIVAL HEIGHT	α_s	α_c	GINGIVAL HEIGHT	α_s	α_c	GINGIVAL HEIGHT	α_s	α_c	GINGIVAL HEIGHT	α_s	α_c	GINGIVAL HEIGHT	α_s	α_c
	0,3 mm			mm			mm			mm			mm		
R	31.323.171.01-2	35°	-	-	-	-	-	-	-	-	-	-	-	-	-
NR	31.313.171.01-2		-	-	-	-	-	-	-	-	-	-	-	-	-

DYNAMIC 3TIBASE®				
GINGIVAL HEIGHT	α_s	α_s	α_s	
	CH=5mm	CH=7mm	CH=9mm	
-	-	-	-	-
-	-	-	-	-

DYNAMIC μ SCANBODY (LAB/CLIN)				DIGITAL ANALOG
SCANBODY	HEIGHT mm	ADAPTOR	SCREWDRIVER ADAPTOR	DIGITAL ANALOG
-	-	-	-	-
-	-	-	-	-

DYNAMIC MILLING TOOL		
DYNAMIC MILLING TOOL	SHANK	α_{di}
33.390.754.01-2	3	25°
33.490.754.01-2	4	
33.690.754.01-2	6	

DYNAMIC SCREWS			
DYNAMIC SCREW	HIGH DYNAMIC SCREW	DYNAMIC SCREWDRIVER	SCREWDRIVER LENGTH (mm)
41.316.079.02-2	-	43.618.201.01-2	18
		43.624.201.01-2	24
		43.632.201.01-2	32

STRAIGHT SCREWS	
STRAIGHT SCREW	SCREWDRIVER Hex. 1.20
-	-

ANALOG	LAB SCANBODY
-	30.412.001.01-2

LIBRARY OPTIONS
GH = Gingival Height
CH = Cement Height
IG = Adaptor 3mm
 α_s = Standard maximum angulation
 α_c = Captive maximum angulation
 α_{di} = Direct to implant maximum angulation
 α_{dp} = Dynamic Premilled maximum angulation
R = Rotational / Non-Engaging
NR = Non Rotational / Engaging

STANDARD DYNAMIC TIBASE®															
	GINGIVAL HEIGHT	α_s	α_c	GINGIVAL HEIGHT	α_s	α_c	GINGIVAL HEIGHT	α_s	α_c	GINGIVAL HEIGHT	α_s	α_c	GINGIVAL HEIGHT	α_s	α_c
	0,5 mm			mm			mm			mm			mm		
R	-	35°	-	-	-	-	-	-	-	-	-	-	-	-	-
NR	31.310.176.01-2		-	-	-	-	-	-	-	-	-	-	-	-	-

DYNAMIC 3TIBASE®				
GINGIVAL HEIGHT	α_s	α_s	α_s	
	CH=5mm	CH=7mm	CH=9mm	
R	-	-	-	-
NR	-	-	-	-

DYNAMIC μ SCANBODY (LAB/CLIN)				DIGITAL ANALOG
SCANBODY	HEIGHT mm	ADAPTOR	SCREWDRIVER ADAPTOR	DIGITAL ANALOG
52.408.138.01-2	8	50.310.176.01-2	43.621.415.01-2	34.610.176.01-2
-	-			
-	-			

DYNAMIC MILLING TOOL		
DYNAMIC MILLING TOOL	SHANK	α_{di}
33.360.756.01-2	3	30°
33.460.756.01-2	4	
33.660.756.01-2	6	

DYNAMIC SCREWS			
DYNAMIC SCREW	HIGH DYNAMIC SCREW	DYNAMIC SCREWDRIVER	SCREWDRIVER LENGTH (mm)
41.314.044.01-2	-	43.618.201.01-2	18
		43.624.201.01-2	24
		43.632.201.01-2	32

STRAIGHT SCREWS	
STRAIGHT SCREW	SCREWDRIVER Hex. 1.20
-	-

ANALOG	LAB SCANBODY
-	30.410.006.01-2

LIBRARY OPTIONS
GH = Gingival Height
CH = Cement Height
IG = Adaptor 3mm
 α_s = Standard maximum angulation
 α_c = Captive maximum angulation
 α_{di} = Direct to implant maximum angulation
 α_{dp} = Dynamic Premilled maximum angulation
R = Rotational / Non-Engaging
NR = Non Rotational / Engaging

STANDARD DYNAMIC TIBASE®															
GINGIVAL HEIGHT		α_s	α_c	GINGIVAL HEIGHT		α_s	α_c	GINGIVAL HEIGHT		α_s	α_c	GINGIVAL HEIGHT		α_s	α_c
1,5 mm				mm				mm				mm			
R	31.320.178.01-2	45°	-	-	-	-	-	-	-	-	-	-	-	-	-
NR	31.310.178.01-2		-	-	-	-	-	-	-	-	-	-	-	-	-

DYNAMIC 3TIBASE®				
GINGIVAL HEIGHT		α_s	α_s	α_s
		CH=5mm	CH= 7mm	CH= 9mm
-	-	-	-	-
-	-	-	-	-

DYNAMIC μ SCANBODY (LAB/CLIN)				DIGITAL ANALOG
SCANBODY	HEIGHT mm	ADAPTOR	SCREWDRIVER ADAPTOR	DIGITAL ANALOG
-	-	-	-	-
-	-	-	-	-

DYNAMIC MILLING TOOL		
DYNAMIC MILLING TOOL	SHANK	α_{di}
-	-	-
-	-	-
-	-	-

DYNAMIC SCREWS			
DYNAMIC SCREW	HIGH DYNAMIC SCREW	DYNAMIC SCREWDRIVER	SCREWDRIVER LENGTH (mm)
41.316.080.01-2	-	43.618.201.01-2	18
		43.624.201.01-2	24
		43.632.201.01-2	32

STRAIGHT SCREWS	
STRAIGHT SCREW	SCREWDRIVER
-	-

ANALOG	LAB SCANBODY
-	30.410.006.01-2

LIBRARY OPTIONS
GH = Gingival Height
CH = Cement Height
IG = Adaptor 3mm
 α_s = Standard maximum angulation
 α_c = Captive maximum angulation
 α_{di} = Direct to implant maximum angulation
 α_{dp} = Dynamic Premilled maximum angulation
R = Rotational / Non-Engaging
NR = Non Rotational / Engaging

STANDARD DYNAMIC TIBASE®															
GINGIVAL HEIGHT		α_s	α_c	GINGIVAL HEIGHT		α_s	α_c	GINGIVAL HEIGHT		α_s	α_c	GINGIVAL HEIGHT		α_s	α_c
0,4 mm				mm				mm				mm			
R	31.322.181.01-2	45°	-	-	-	-	-	-	-	-	-	-	-	-	-
NR	-		-	-	-	-	-	-	-	-	-	-	-	-	-

DYNAMIC 3TIBASE®				
GINGIVAL HEIGHT		α_s	α_s	α_s
		CH=5mm	CH= 7mm	CH= 9mm
R	31.322.181.21-2	30°	30°	20°
NR	-		-	-

DYNAMIC μ SCANBODY (LAB/CLIN)				DIGITAL ANALOG
SCANBODY	HEIGHT mm	ADAPTOR	SCREWDRIVER ADAPTOR	DIGITAL ANALOG
52.408.112.01-2	8	50.312.181.01-2	43.620.411.01-2	-
-	-			-
-	-			-

DYNAMIC MILLING TOOL			SHANK	α_{di}	SCANALOG
DYNAMIC MILLING TOOL	SHANK	α_{di}			
33.360.756.01-2	3	30°	-	23.412.181.01-2	
33.460.756.01-2	4		-		
33.660.756.01-2	6		-		

DYNAMIC SCREWS			
DYNAMIC SCREW	HIGH DYNAMIC SCREW	DYNAMIC SCREWDRIVER	SCREWDRIVER LENGTH (mm)
41.318.043.01-2	-	43.618.201.01-2	18
		43.624.201.01-2	24
		43.632.201.01-2	32

STRAIGHT SCREWS	
STRAIGHT SCREW	SCREWDRIVER
-	-

ANALOG	LAB SCANBODY
-	30.413.005.01-2

LIBRARY OPTIONS
GH = Gingival Height
CH = Cement Height
IG = Adaptor 3mm

STANDARD DYNAMIC TIBASE®															
	GINGIVAL HEIGHT	α_s	α_c	GINGIVAL HEIGHT	α_s	α_c	GINGIVAL HEIGHT	α_s	α_c	GINGIVAL HEIGHT	α_s	α_c	GINGIVAL HEIGHT	α_s	α_c
	0,5 mm			mm			mm			mm			mm		
R	31.322.183.01-2	45°	-	-	-	-	-	-	-	-	-	-	-	-	-
NR	-			-			-			-			-		

DYNAMIC 3TIBASE®				
GINGIVAL HEIGHT	α_s	α_s	α_s	
	CH=5mm	CH= 7mm	CH= 9mm	
-	-	-	-	-
-	-	-	-	-

DYNAMIC μ SCANBODY (LAB/CLIN)				DIGITAL ANALOG
SCANBODY	HEIGHT mm	ADAPTOR	SCREWDRIVER ADAPTOR	DIGITAL ANALOG
52.408.136.01-2	8	50.312.183.01-2	43.620.411.01-2	34.612.183.01-2
-	-			
-	-			

DYNAMIC MILLING TOOL		
DYNAMIC MILLING TOOL	SHANK	α_{di}
33.330.734.01-2	3	30°
33.430.734.01-2	4	
33.630.734.01-2	6	

DYNAMIC SCREWS			
DYNAMIC SCREW	HIGH DYNAMIC SCREW	DYNAMIC SCREWDRIVER	SCREWDRIVER LENGTH (mm)
41.316.048.02-2	-	43.618.201.01-2	18
		43.624.201.01-2	24
		43.632.201.01-2	32

STRAIGHT SCREWS	
STRAIGHT SCREW	SCREWDRIVER
-	-

ANALOG	LAB SCANBODY
-	-

LIBRARY OPTIONS
GH = Gingival Height
CH = Cement Height
IG = Adaptor 3mm
 α_s = Standard maximum angulation
 α_c = Captive maximum angulation
 α_{di} = Direct to implant maximum angulation
 α_{dp} = Dynamic Premilled maximum angulation
R = Rotational / Non-Engaging
NR = Non Rotational / Engaging

STANDARD DYNAMIC TIBASE®															
	GINGIVAL HEIGHT	α_s	α_c	GINGIVAL HEIGHT	α_s	α_c	GINGIVAL HEIGHT	α_s	α_c	GINGIVAL HEIGHT	α_s	α_c	GINGIVAL HEIGHT	α_s	α_c
	1,2 mm			2,5 mm			3,5 mm			mm			mm		
R	31.323.186.01-2	40°	30°	31.323.186.02-2	20°	18°	31.323.186.03-2	15°	-	-	°	°	-	°	°
NR	31.313.186.01-2			31.313.186.02-2			31.313.186.03-2			-	°	°	-	°	°

DYNAMIC 3TIBASE®								
GINGIVAL HEIGHT	α_s	α_s	α_s	GINGIVAL HEIGHT	α_s	α_s	α_s	
	1,2 mm	CH=5mm	CH= 7mm	CH= 9mm	2,5 mm	CH=5mm	CH= 7mm	CH= 9mm
R	31.323.186.21-2	30°	25°	15°	31.323.186.22-2	30°	25°	15°
NR	31.313.186.21-2				31.313.186.22-2			

DYNAMIC μ SCANBODY (LAB/CLIN)				DIGITAL ANALOG
SCANBODY	HEIGHT mm	ADAPTOR	SCREWDRIVER ADAPTOR	DIGITAL ANALOG
52.408.101.01-2	8	50.313.186.04-2 (IG=3mm)	43.621.410.01-2 43.624.410.01-2	34.613.186.01-2
52.410.101.01-2	10			
52.412.101.01-2	12			

DYNAMIC MILLING TOOL		
DYNAMIC MILLING TOOL	SHANK	α_{di}
33.330.734.01-2	3	25
33.430.734.01-2	4	
33.630.734.01-2	6	

DYNAMIC SCREWS			
DYNAMIC SCREW	HIGH DYNAMIC SCREW	DYNAMIC SCREWDRIVER	SCREWDRIVER LENGTH (mm)
41.316.084.02-2	-	43.618.201.01-2	18
		43.624.201.01-2	24
		43.632.201.01-2	32

STRAIGHT SCREWS	
STRAIGHT SCREW	SCREWDRIVER
-	-

ANALOG	LAB SCANBODY
-	30.413.002.01-2

MULTI-UNIT					
	GINGIVAL HEIGHT	GINGIVAL HEIGHT	GINGIVAL HEIGHT	GINGIVAL HEIGHT	GINGIVAL HEIGHT
	1 mm	2 mm	3 mm	4 mm	5 mm
R	42.303.186.01-2	42.303.186.02-2	42.303.186.03-2	42.303.186.04-2	42.303.186.05-2

LIBRARY OPTIONS
GH = Gingival Height
CH = Cement Height
IG = Adaptor 3mm
 α_s = Standard maximum angulation
 α_c = Captive maximum angulation
 α_{di} = Direct to implant maximum angulation
 α_{dp} = Dynamic Premilled maximum angulation
R = Rotational / Non-Engaging
NR = Non Rotational / Engaging

STANDARD DYNAMIC TIBASE®															
	GINGIVAL HEIGHT	α_s	α_c	GINGIVAL HEIGHT	α_s	α_c	GINGIVAL HEIGHT	α_s	α_c	GINGIVAL HEIGHT	α_s	α_c	GINGIVAL HEIGHT	α_s	α_c
	0,3 mm			0,5 mm			1 mm			mm			mm		
R	31.322.009.01-2	45°	25°	31.322.009.02-2	25°	25°	31.322.009.03-2	25°	-	-	-	-	-	-	-
NR	31.312.009.01-2			31.312.009.02-2			31.312.009.03-2			-			-		

DYNAMIC 3TIBASE®				
GINGIVAL HEIGHT	α_s	α_s	α_s	
	CH=5mm	CH=7mm	CH=9mm	
-	-	-	-	-
-	-	-	-	-

DYNAMIC μ SCANBODY (LAB/CLIN)				DIGITAL ANALOG
SCANBODY	HEIGHT mm	ADAPTOR	SCREWDRIVER ADAPTOR	DIGITAL ANALOG
52.410.114.01-2	10	50.312.187.01-2	43.621.410.01-2	34.612.187.01-2
			43.624.410.01-2	
52.412.114.01-2	12			

DYNAMIC MILLING TOOL		
DYNAMIC MILLING TOOL	SHANK	α_{di}
33.390.716.01-2	3	25°
33.490.716.01-2	4	
33.690.716.01-2	6	

DYNAMIC SCREWS			
DYNAMIC SCREW	HIGH DYNAMIC SCREW	DYNAMIC SCREWDRIVER	SCREWDRIVER LENGTH (mm)
41.316.059.01-2	-	43.618.201.01-2	18
		43.624.201.01-2	24
		43.632.201.01-2	32

STRAIGHT SCREWS	
STRAIGHT SCREW	SCREWDRIVER
-	-

ANALOG	LAB SCANBODY
-	30.412.001.01-2

LIBRARY OPTIONS
GH = Gingival Height
CH = Cement Height
IG = Adaptor 3mm
 α_s = Standard maximum angulation
 α_c = Captive maximum angulation
 α_{di} = Direct to implant maximum angulation
 α_{dp} = Dynamic Premilled maximum angulation
R = Rotational / Non-Engaging
NR = Non Rotational / Engaging

STANDARD DYNAMIC TIBASE®															
	GINGIVAL HEIGHT	α_s	α_c	GINGIVAL HEIGHT	α_s	α_c	GINGIVAL HEIGHT	α_s	α_c	GINGIVAL HEIGHT	α_s	α_c	GINGIVAL HEIGHT	α_s	α_c
	1,5 mm			mm			3,5 mm			mm			mm		
R	31.320.188.01-2	45°	-	-	-	-	-	-	-	-	-	-	-	-	-
NR	31.310.188.01-2			-			-			-			-		

DYNAMIC 3TIBASE®				
GINGIVAL HEIGHT	α_s	α_s	α_s	
	CH=5mm	CH=7mm	CH=9mm	
-	-	-	-	-
-	-	-	-	-

DYNAMIC μ SCANBODY (LAB/CLIN)				DIGITAL ANALOG
SCANBODY	HEIGHT mm	ADAPTOR	SCREWDRIVER ADAPTOR	DIGITAL ANALOG
-	-	-	-	-
-	-			
-	-			

DYNAMIC MILLING TOOL		
DYNAMIC MILLING TOOL	SHANK	α_{di}
-	-	-
-	-	
-	-	

DYNAMIC SCREWS			
DYNAMIC SCREW	HIGH DYNAMIC SCREW	DYNAMIC SCREWDRIVER	SCREWDRIVER LENGTH (mm)
41.315.078.01-2	-	43.618.201.01-2	18
		43.624.201.01-2	24
		43.632.201.01-2	32

STRAIGHT SCREWS	
STRAIGHT SCREW	SCREWDRIVER
-	-

ANALOG	LAB SCANBODY
-	30.410.006.01-2

LIBRARY OPTIONS
GH = Gingival Height
CH = Cement Height
IG = Adaptor 3mm
 α_s = Standard maximum angulation
 α_c = Captive maximum angulation
 α_{di} = Direct to implant maximum angulation
 α_{dp} = Dynamic Premilled maximum angulation
R = Rotational / Non-Engaging
NR = Non Rotational / Engaging

STANDARD DYNAMIC TIBASE®															
GINGIVAL HEIGHT		α_s	α_c	GINGIVAL HEIGHT		α_s	α_c	GINGIVAL HEIGHT		α_s	α_c	GINGIVAL HEIGHT		α_s	α_c
1,8 mm				mm				mm				mm			
R	31.320.190.01-2	45°	-	-	-	-	-	-	-	-	-	-	-	-	-
NR	31.310.190.01-2			-	-	-	-	-	-	-	-	-	-	-	-

DYNAMIC 3TIBASE®				
GINGIVAL HEIGHT		α_s	α_s	α_s
		CH=5mm	CH= 7mm	CH= 9mm
-	-	-	-	-
-	-	-	-	-

DYNAMIC μ SCANBODY (LAB/CLIN)				DIGITAL ANALOG
SCANBODY	HEIGHT mm	ADAPTOR	SCREWDRIVER ADAPTOR	DIGITAL ANALOG
-	-	-	-	-
-	-	-	-	-
-	-	-	-	-

DYNAMIC MILLING TOOL		
DYNAMIC MILLING TOOL	SHANK	α_{di}
-	-	-
-	-	-
-	-	-

DYNAMIC SCREWS			
DYNAMIC SCREW	HIGH DYNAMIC SCREW	DYNAMIC SCREWDRIVER	SCREWDRIVER LENGTH (mm)
41.316.084.02-2	-	43.618.201.01-2	18
		43.624.201.01-2	24
		43.632.201.01-2	32

STRAIGHT SCREWS	
STRAIGHT SCREW	SCREWDRIVER
-	-

ANALOG	LAB SCANBODY
-	30.410.006.01-2

LIBRARY OPTIONS
GH = Gingival Height
CH = Cement Height
IG = Adaptor 3mm
 α_s = Standard maximum angulation
 α_c = Captive maximum angulation
 α_{di} = Direct to implant maximum angulation
 α_{dp} = Dynamic Premilled maximum angulation
R = Rotational / Non-Engaging
NR = Non Rotational / Engaging

STANDARD DYNAMIC TIBASE®															
GINGIVAL HEIGHT		α_s	α_c	GINGIVAL HEIGHT		α_s	α_c	GINGIVAL HEIGHT		α_s	α_c	GINGIVAL HEIGHT		α_s	α_c
0,8 mm				mm				mm				mm			
R	31.322.191.01-2	45°	-	-	-	-	-	-	-	-	-	-	-	-	-
NR	31.312.191.01-2			-	-	-	-	-	-	-	-	-	-	-	-

DYNAMIC 3TIBASE®				
GINGIVAL HEIGHT		α_s	α_s	α_s
		CH=5mm	CH= 7mm	CH= 9mm
-	-	-	-	-
-	-	-	-	-

DYNAMIC μ SCANBODY (LAB/CLIN)				DIGITAL ANALOG
SCANBODY	HEIGHT mm	ADAPTOR	SCREWDRIVER ADAPTOR	DIGITAL ANALOG
-	-	-	-	-
-	-	-	-	-
-	-	-	-	-

DYNAMIC MILLING TOOL		
DYNAMIC MILLING TOOL	SHANK	α_{di}
-	-	-
-	-	-
-	-	-

DYNAMIC SCREWS			
DYNAMIC SCREW	HIGH DYNAMIC SCREW	DYNAMIC SCREWDRIVER	SCREWDRIVER LENGTH (mm)
41.316.084.02-2	-	43.618.201.01-2	18
		43.624.201.01-2	24
		43.632.201.01-2	32

STRAIGHT SCREWS	
STRAIGHT SCREW	SCREWDRIVER
-	-

ANALOG	LAB SCANBODY
-	30.412.001.01-2

LIBRARY OPTIONS
GH = Gingival Height
CH = Cement Height
IG = Adaptor 3mm
 α_s = Standard maximum angulation
 α_c = Captive maximum angulation
 α_{di} = Direct to implant maximum angulation
 α_{dp} = Dynamic Premilled maximum angulation
R = Rotational / Non-Engaging
NR = Non Rotational / Engaging

STANDARD DYNAMIC TIBASE®															
	GINGIVAL HEIGHT	α_s	α_c	GINGIVAL HEIGHT	α_s	α_c	GINGIVAL HEIGHT	α_s	α_c	GINGIVAL HEIGHT	α_s	α_c	GINGIVAL HEIGHT	α_s	α_c
	0,3 mm			mm			mm			mm			mm		
R	31.323.192.01-2	45°	-	-	-	-	-	-	-	-	-	-	-	-	-
-	-	-	-	-	-	-	-	-	-	-	-	-	-	-	-

DYNAMIC 3TIBASE®				
GINGIVAL HEIGHT	α_s	α_s	α_s	
	CH=5mm	CH= 7mm	CH= 9mm	
-	-	-	-	-
-	-	-	-	-

DYNAMIC μ SCANBODY (LAB/CLIN)				DIGITAL ANALOG
SCANBODY	HEIGHT mm	ADAPTOR	SCREWDRIVER ADAPTOR	DIGITAL ANALOG
-	-	-	-	-
-	-	-	-	-
-	-	-	-	-

DYNAMIC MILLING TOOL		
DYNAMIC MILLING TOOL	SHANK	α_{di}
-	-	-
-	-	-
-	-	-

DYNAMIC SCREWS			
DYNAMIC SCREW	HIGH DYNAMIC SCREW	DYNAMIC SCREWDRIVER	SCREWDRIVER LENGTH (mm)
41.316.048.01-2	-	43.618.201.01-2	18
		43.624.201.01-2	24
		43.632.201.01-2	32

STRAIGHT SCREWS	
STRAIGHT SCREW	SCREWDRIVER
-	-

ANALOG	LAB SCANBODY
-	30.413.005.01-2

LIBRARY OPTIONS
GH = Gingival Height
CH = Cement Height
IG = Adaptor 3mm
 α_s = Standard maximum angulation
 α_c = Captive maximum angulation
 α_{di} = Direct to implant maximum angulation
 α_{dp} = Dynamic Premilled maximum angulation
R = Rotational / Non-Engaging
NR = Non Rotational / Engaging

STANDARD DYNAMIC TIBASE®															
	GINGIVAL HEIGHT	α_s	α_c	GINGIVAL HEIGHT	α_s	α_c	GINGIVAL HEIGHT	α_s	α_c	GINGIVAL HEIGHT	α_s	α_c	GINGIVAL HEIGHT	α_s	α_c
	0,3 mm			mm			mm			mm			mm		
R	31.323.193.01-2	45°	-	-	-	-	-	-	-	-	-	-	-	-	-
-	-	-	-	-	-	-	-	-	-	-	-	-	-	-	-

DYNAMIC 3TIBASE®				
GINGIVAL HEIGHT	α_s	α_s	α_s	
	CH=5mm	CH= 7mm	CH= 9mm	
-	-	-	-	-
-	-	-	-	-

DYNAMIC μ SCANBODY (LAB/CLIN)				DIGITAL ANALOG
SCANBODY	HEIGHT mm	ADAPTOR	SCREWDRIVER ADAPTOR	DIGITAL ANALOG
-	-	-	-	-
-	-	-	-	-
-	-	-	-	-

DYNAMIC MILLING TOOL		
DYNAMIC MILLING TOOL	SHANK	α_{di}
-	-	-
-	-	-
-	-	-

REFERENCE SCANBODY		
SCANBODY	PEEK PINS	mm
54.322.193.31-2	49.414.000.01-2	6
	49.415.000.01-2	9
	49.416.000.01-2	13

DYNAMIC SCREWS			
DYNAMIC SCREW	HIGH DYNAMIC SCREW	DYNAMIC SCREWDRIVER	SCREWDRIVER LENGTH (mm)
41.318.051.02-2	-	43.618.201.01-2	18
		43.624.201.01-2	24
		43.632.201.01-2	32

STRAIGHT SCREWS	
STRAIGHT SCREW	SCREWDRIVER
-	-

ANALOG	LAB SCANBODY
-	30.413.005.01-2

LIBRARY OPTIONS
GH = Gingival Height
CH = Cement Height
IG = Adaptor 3mm
 α_s = Standard maximum angulation
 α_c = Captive maximum angulation
 α_{di} = Direct to implant maximum angulation
 α_{dp} = Dynamic Premilled maximum angulation
R = Rotational / Non-Engaging
NR = Non Rotational / Engaging

COMPATIBLE with 0195

STANDARD DYNAMIC TIBASE®															
	GINGIVAL HEIGHT	α_s	α_c	GINGIVAL HEIGHT	α_s	α_c	GINGIVAL HEIGHT	α_s	α_c	GINGIVAL HEIGHT	α_s	α_c	GINGIVAL HEIGHT	α_s	α_c
	0,5 mm			mm			mm			mm			mm		
R	31.323.195.01-2	45°	-	-	-	-	-	-	-	-	-	-	-	-	-
-	-	-	-	-	-	-	-	-	-	-	-	-	-	-	-

DYNAMIC 3TIBASE®				
	GINGIVAL HEIGHT	α_s	α_s	α_s
		CH=5mm	CH= 7mm	CH= 9mm
R	31.323.195.21-2	30°	25°	20°
NR	-	-	-	-

DYNAMIC μ SCANBODY (LAB/CLIN)				DIGITAL ANALOG
SCANBODY	HEIGHT mm	ADAPTOR	SCREWDRIVER ADAPTOR	DIGITAL ANALOG
-	-	-	-	-
-	-	-	-	-
-	-	-	-	-

DYNAMIC MILLING TOOL		
DYNAMIC MILLING TOOL	SHANK	α_{di}
-	-	-
-	-	-
-	-	-

DYNAMIC SCREWS			
DYNAMIC SCREW	HIGH DYNAMIC SCREW	DYNAMIC SCREWDRIVER	SCREWDRIVER LENGTH (mm)
41.317.041.01-2	-	43.618.201.01-2	18
		43.624.201.01-2	24
		43.632.201.01-2	32

STRAIGHT SCREWS	
STRAIGHT SCREW	SCREWDRIVER
-	-

ANALOG	LAB SCANBODY
-	30.413.005.01-2

LIBRARY OPTIONS
GH = Gingival Height
CH = Cement Height
IG = Adaptor 3mm
 α_s = Standard maximum angulation
 α_c = Captive maximum angulation
 α_{di} = Direct to implant maximum angulation
 α_{dp} = Dynamic Premilled maximum angulation
R = Rotational / Non-Engaging
NR = Non Rotational / Engaging

COMPATIBLE with 0196

STANDARD DYNAMIC TIBASE®															
	GINGIVAL HEIGHT	α_s	α_c	GINGIVAL HEIGHT	α_s	α_c	GINGIVAL HEIGHT	α_s	α_c	GINGIVAL HEIGHT	α_s	α_c	GINGIVAL HEIGHT	α_s	α_c
	1,2 mm			2 mm			3 mm			mm			mm		
R	31.320.196.01-2	40°	-	31.320.196.02-2	25°	-	31.320.196.03-2	25°	-	-	°	°	-	°	°
NR	31.310.196.01-2	-	-	31.310.196.02-2	-	-	31.310.196.03-2	-	-	-	°	°	-	°	°

DYNAMIC 3TIBASE®				
	GINGIVAL HEIGHT	α_s	α_s	α_s
		CH=5mm	CH= 7mm	CH= 9mm
-	-	-	-	-
-	-	-	-	-

DYNAMIC μ SCANBODY (LAB/CLIN)				DIGITAL ANALOG
SCANBODY	HEIGHT mm	ADAPTOR	SCREWDRIVER ADAPTOR	DIGITAL ANALOG
-	-	-	-	-
-	-	-	-	-
-	-	-	-	-

DYNAMIC MILLING TOOL		
DYNAMIC MILLING TOOL	SHANK	α_{di}
-	-	-
-	-	-
-	-	-

DYNAMIC SCREWS			
DYNAMIC SCREW	HIGH DYNAMIC SCREW	DYNAMIC SCREWDRIVER	SCREWDRIVER LENGTH (mm)
41.316.086.01-2	-	43.618.201.01-2	18
		43.624.201.01-2	24
		43.632.201.01-2	32

STRAIGHT SCREWS	
STRAIGHT SCREW	SCREWDRIVER
-	-

ANALOG	LAB SCANBODY
-	30.410.006.01-2

LIBRARY OPTIONS
GH = Gingival Height
CH = Cement Height
IG = Adaptor 3mm
 α_s = Standard maximum angulation
 α_c = Captive maximum angulation
 α_{di} = Direct to implant maximum angulation
 α_{dp} = Dynamic Premilled maximum angulation
R = Rotational / Non-Engaging
NR = Non Rotational / Engaging

STANDARD DYNAMIC TIBASE®															
	GINGIVAL HEIGHT	α_s	α_c	GINGIVAL HEIGHT	α_s	α_c	GINGIVAL HEIGHT	α_s	α_c	GINGIVAL HEIGHT	α_s	α_c	GINGIVAL HEIGHT	α_s	α_c
	1,2 mm			2 mm			3 mm			mm			mm		
R	31.322.197.01-2	35°	-	31.322.197.02-2	20°	-	31.322.197.03-2	20°	-	-	°	°	-	°	°
NR	31.312.197.01-2			31.312.197.02-2			31.312.197.03-2			-	°	°	-	°	°

DYNAMIC 3TIBASE®				
GINGIVAL HEIGHT	α_s	α_s	α_s	
	CH=5mm	CH= 7mm	CH= 9mm	
-	-	-	-	-
-	-	-	-	-

DYNAMIC μ SCANBODY (LAB/CLIN)				DIGITAL ANALOG
SCANBODY	HEIGHT mm	ADAPTOR	SCREWDRIVER ADAPTOR	DIGITAL ANALOG
-	-	-	-	-
-	-	-	-	-

DYNAMIC MILLING TOOL		
DYNAMIC MILLING TOOL	SHANK	α_{di}
-	-	-
-	-	-
-	-	-

DYNAMIC SCREWS			
DYNAMIC SCREW	HIGH DYNAMIC SCREW	DYNAMIC SCREWDRIVER	SCREWDRIVER LENGTH (mm)
41.316.086.01-2	-	43.618.201.01-2	18
		43.624.201.01-2	24
		43.632.201.01-2	32

STRAIGHT SCREWS	
STRAIGHT SCREW	SCREWDRIVER
-	-

ANALOG	LAB SCANBODY
-	30.412.001.01-2

LIBRARY OPTIONS
GH = Gingival Height
CH = Cement Height
IG = Adaptor 3mm
 α_s = Standard maximum angulation
 α_c = Captive maximum angulation
 α_{di} = Direct to implant maximum angulation
 α_{dp} = Dynamic Premilled maximum angulation
R = Rotational / Non-Engaging
NR = Non Rotational / Engaging

STANDARD DYNAMIC TIBASE®															
	GINGIVAL HEIGHT	α_s	α_c	GINGIVAL HEIGHT	α_s	α_c	GINGIVAL HEIGHT	α_s	α_c	GINGIVAL HEIGHT	α_s	α_c	GINGIVAL HEIGHT	α_s	α_c
	1,2 mm			mm			mm			mm			mm		
R	31.324.198.01-2	40°	-	-	-	-	-	-	-	-	°	°	-	°	°
NR	31.314.198.01-2			-	-	-	-	-	-	-	-	°	°	-	°

DYNAMIC 3TIBASE®				
GINGIVAL HEIGHT	α_s	α_s	α_s	
	CH=5mm	CH= 7mm	CH= 9mm	
-	-	-	-	-
-	-	-	-	-

DYNAMIC μ SCANBODY (LAB/CLIN)				DIGITAL ANALOG
SCANBODY	HEIGHT mm	ADAPTOR	SCREWDRIVER ADAPTOR	DIGITAL ANALOG
-	-	-	-	-
-	-	-	-	-

DYNAMIC MILLING TOOL		
DYNAMIC MILLING TOOL	SHANK	α_{di}
-	-	-
-	-	-
-	-	-

DYNAMIC SCREWS			
DYNAMIC SCREW	HIGH DYNAMIC SCREW	DYNAMIC SCREWDRIVER	SCREWDRIVER LENGTH (mm)
41.316.086.01-2	-	43.618.201.01-2	18
		43.624.201.01-2	24
		43.632.201.01-2	32

STRAIGHT SCREWS	
STRAIGHT SCREW	SCREWDRIVER
-	-

ANALOG	LAB SCANBODY
-	30.414.003.01-2

LIBRARY OPTIONS
GH = Gingival Height
CH = Cement Height
IG = Adaptor 3mm
 α_s = Standard maximum angulation
 α_c = Captive maximum angulation
 α_{di} = Direct to implant maximum angulation
 α_{dp} = Dynamic Premilled maximum angulation
R = Rotational / Non-Engaging
NR = Non Rotational / Engaging

STANDARD DYNAMIC TIBASE®															
	GINGIVAL HEIGHT	α_s	α_c	GINGIVAL HEIGHT	α_s	α_c	GINGIVAL HEIGHT	α_s	α_c	GINGIVAL HEIGHT	α_s	α_c	GINGIVAL HEIGHT	α_s	α_c
	0,3 mm			mm			mm			mm			mm		
R	31.322.205.01-2	45°	-	-	°	°	-	°	°	-	°	°	-	°	°
NR	-			-	°	°	-	°	°	-	°	°	-	°	°

DYNAMIC 3TIBASE®				
GINGIVAL HEIGHT	α_s	α_s	α_s	
	CH=5mm	CH= 7mm	CH= 9mm	
-	-	-	-	
-	-	-	-	

DYNAMIC μ SCANBODY (LAB/CLIN)				DIGITAL ANALOG
SCANBODY	HEIGHT mm	ADAPTOR	SCREWDRIVER ADAPTOR	DIGITAL ANALOG
52.408.112.01-2	8	50.312.205.01-2	43.620.411.01-2	34.612.205.01-2
-	-			
-	-			

DYNAMIC MILLING TOOL		
DYNAMIC MILLING TOOL	SHANK	α_{di}
33.390.716.01-2	3	30°
33.490.716.01-2	4	
33.690.716.01-2	6	

DYNAMIC SCREWS			
DYNAMIC SCREW	HIGH DYNAMIC SCREW	DYNAMIC SCREWDRIVER	SCREWDRIVER LENGTH (mm)
41.317.040.01-2	-	43.618.201.01-2	18
		43.624.201.01-2	24
		43.632.201.01-2	32

STRAIGHT SCREWS	
STRAIGHT SCREW	SCREWDRIVER
-	-

ANALOG	LAB SCANBODY
-	30.412.001.01-2

LIBRARY OPTIONS
GH = Gingival Height
CH = Cement Height
IG = Adaptor 3mm
 α_s = Standard maximum angulation
 α_c = Captive maximum angulation
 α_{di} = Direct to implant maximum angulation
 α_{dp} = Dynamic Premilled maximum angulation
R = Rotational / Non-Engaging
NR = Non Rotational / Engaging

STANDARD DYNAMIC TIBASE®															
	GINGIVAL HEIGHT	α_s	α_c	GINGIVAL HEIGHT	α_s	α_c	GINGIVAL HEIGHT	α_s	α_c	GINGIVAL HEIGHT	α_s	α_c	GINGIVAL HEIGHT	α_s	α_c
	1,5 mm			mm			3 mm			4 mm			mm		
R	31.320.207.01-2	35°	-	-	-	-	31.320.207.03-2	20°	-	31.320.207.04-2	15°	-	-	-	-
NR	31.310.207.01-2			-			31.310.207.03-2			31.310.207.04-2			-	-	-

DYNAMIC 3TIBASE®								
GINGIVAL HEIGHT	α_s	α_s	α_s	α_s	α_s	α_s	α_s	
1,5 mm	CH=5mm	CH= 7mm	CH= 9mm	3 mm	CH=5mm	CH= 7mm	CH= 9mm	
R	31.320.207.21-2	25°	20°	15°	31.320.207.23-2	20°	15°	10°
NR	31.310.207.21-2				31.310.207.23-2			

DYNAMIC μ SCANBODY (LAB/CLIN)				DIGITAL ANALOG
SCANBODY	HEIGHT mm	ADAPTOR	SCREWDRIVER ADAPTOR	DIGITAL ANALOG
52.410.103.01-2	10	50.310.207.03-2 IG=3mm	43.621.410.01-2 43.624.410.01-2	34.610.207.01-2
-	-			
52.412.103.01-2	12			

DYNAMIC MILLING TOOL		
DYNAMIC MILLING TOOL	SHANK	α_{di}
33.345.856.01-2*	3	30°
33.445.856.01-2*	4	
33.645.856.01-2*	6	

*Only for R

DYNAMIC SCREWS			
DYNAMIC SCREW	HIGH DYNAMIC SCREW	DYNAMIC SCREWDRIVER	SCREWDRIVER LENGTH (mm)
41.316.066.01-2	-	43.618.201.01-2	18
		43.624.201.01-2	24
		43.632.201.01-2	32

STRAIGHT SCREWS	
STRAIGHT SCREW	SCREWDRIVER
-	-

ANALOG	LAB SCANBODY
-	30.410.006.01-2

MULTI-UNIT				
	GINGIVAL HEIGHT	GINGIVAL HEIGHT	GINGIVAL HEIGHT	GINGIVAL HEIGHT
	1 mm	2 mm	3 mm	4 mm
R	42.302.207.01-2	42.302.207.02-2	42.302.207.03-2	42.302.207.04-2

LIBRARY OPTIONS
GH = Gingival Height
CH = Cement Height
IG = Adaptor 3mm
 α_s = Standard maximum angulation
 α_c = Captive maximum angulation
 α_{di} = Direct to implant maximum angulation
 α_{dp} = Dynamic Premilled maximum angulation
R = Rotational / Non-Engaging
NR = Non Rotational / Engaging

COMPATIBLE with 0208

STANDARD DYNAMIC TIBASE®															
GINGIVAL HEIGHT		α_s	α_c	GINGIVAL HEIGHT		α_s	α_c	GINGIVAL HEIGHT		α_s	α_c	GINGIVAL HEIGHT		α_s	α_c
1,5 mm				mm				mm				mm			
R	31.324.208.01-2	45°	-	-	-	-	-	-	-	-	-	-	-	-	-
NR	31.314.208.01-2		-	-	-	-	-	-	-	-	-	-	-	-	-

DYNAMIC 3TIBASE®				
GINGIVAL HEIGHT		α_s	α_s	α_s
		CH=5mm	CH= 7mm	CH= 9mm
-	-	-	-	-
-	-	-	-	-

DYNAMIC μ SCANBODY (LAB/CLIN)			DIGITAL ANALOG	
SCANBODY	HEIGHT mm	ADAPTOR	SCREWDRIVER ADAPTOR	DIGITAL ANALOG
52.410.103.01-2	10	50.310.207.03-2 IG=3mm	43.621.410.01-2 43.624.410.01-2	34.614.208.01-2
52.412.103.01-2	12			

DYNAMIC MILLING TOOL		
DYNAMIC MILLING TOOL	SHANK	α_{di}
33.345.856.01-2*	3	30°
33.445.856.01-2*	4	
33.645.856.01-2*	6	

*Only for R

DYNAMIC SCREWS			
DYNAMIC SCREW	HIGH DYNAMIC SCREW	DYNAMIC SCREWDRIVER	SCREWDRIVER LENGTH (mm)
41.316.066.01-2	-	43.618.201.01-2	18
		43.624.201.01-2	24
		43.632.201.01-2	32

STRAIGHT SCREWS	
STRAIGHT SCREW	SCREWDRIVER
-	-

ANALOG	LAB SCANBODY
-	30.414.003.01-2

MULTI-UNIT				
GINGIVAL HEIGHT		GINGIVAL HEIGHT		GINGIVAL HEIGHT
1 mm		2 mm		3 mm
4 mm				
R	42.302.207.01-2	42.302.207.02-2	42.302.207.03-2	42.302.207.04-2

LIBRARY OPTIONS
GH = Gingival Height
CH = Cement Height
IG = Adaptor 3mm
 α_s = Standard maximum angulation
 α_c = Captive maximum angulation
 α_{di} = Direct to implant maximum angulation
 α_{dp} = Dynamic Premilled maximum angulation
R = Rotational / Non-Engaging
NR = Non Rotational / Engaging

COMPATIBLE with 0229

STANDARD DYNAMIC TIBASE®															
GINGIVAL HEIGHT		α_s	α_c	GINGIVAL HEIGHT		α_s	α_c	GINGIVAL HEIGHT		α_s	α_c	GINGIVAL HEIGHT		α_s	α_c
0,5 mm				mm				mm				mm			
R	31.320.229.01-2	40°	-	-	-	-	-	-	-	-	-	-	-	-	-
NR	31.310.229.01-2		-	-	-	-	-	-	-	-	-	-	-	-	-

DYNAMIC 3TIBASE®				
GINGIVAL HEIGHT		α_s	α_s	α_s
		CH=5mm	CH= 7mm	CH= 9mm
-	-	-	-	-
-	-	-	-	-

DYNAMIC μ SCANBODY (LAB/CLIN)			DIGITAL ANALOG	
SCANBODY	HEIGHT mm	ADAPTOR	SCREWDRIVER ADAPTOR	DIGITAL ANALOG
-	-	-	-	-
-	-	-	-	-

DYNAMIC MILLING TOOL		
DYNAMIC MILLING TOOL	SHANK	α_{di}
-	-	-
-	-	-

DYNAMIC SCREWS			
DYNAMIC SCREW	HIGH DYNAMIC SCREW	DYNAMIC SCREWDRIVER	SCREWDRIVER LENGTH (mm)
41.316.064.01-2	-	43.618.201.01-2	18
		43.624.201.01-2	24
		43.632.201.01-2	32

STRAIGHT SCREWS	
STRAIGHT SCREW	SCREWDRIVER
-	-

ANALOG	LAB SCANBODY
-	30.410.006.01-2

LIBRARY OPTIONS
GH = Gingival Height
CH = Cement Height
IG = Adaptor 3mm
 α_s = Standard maximum angulation
 α_c = Captive maximum angulation
 α_{di} = Direct to implant maximum angulation
 α_{dp} = Dynamic Premilled maximum angulation
R = Rotational / Non-Engaging
NR = Non Rotational / Engaging

COMPATIBLE with 0245

STANDARD DYNAMIC TIBASE®

	GINGIVAL HEIGHT	α_s	α_c	GINGIVAL HEIGHT	α_s	α_c	GINGIVAL HEIGHT	α_s	α_c	GINGIVAL HEIGHT	α_s	α_c	GINGIVAL HEIGHT	α_s	α_c
	0,6 mm			mm			mm			mm			mm		
R	31.323.245.01-2	40°	-	-	-	-	-	-	-	-	-	-	-	-	-
NR	-			-	-	-	-	-	-	-	-	-	-	-	-

DYNAMIC 3TIBASE®

GINGIVAL HEIGHT	α_s	α_s	α_s
	CH=5mm	CH= 7mm	CH= 9mm
-	-	-	-
-	-	-	-

DYNAMIC μ SCANBODY (LAB/CLIN)

DIGITAL ANALOG

SCANBODY	HEIGHT mm	ADAPTOR	SCREWDRIVER ADAPTOR	DIGITAL ANALOG
-	-	-	-	-
-	-	-	-	-
-	-	-	-	-

DYNAMIC MILLING TOOL

DYNAMIC MILLING TOOL	SHANK	α_{di}
-	-	-
-	-	-
-	-	-

DYNAMIC SCREWS

DYNAMIC SCREW	HIGH DYNAMIC SCREW	DYNAMIC SCREWDRIVER	SCREWDRIVER LENGTH (mm)
41.314.039.01-2	-	43.618.201.01-2	18
		43.624.201.01-2	24
		43.632.201.01-2	32

STRAIGHT SCREWS

STRAIGHT SCREW	SCREWDRIVER
-	-

ANALOG

LAB SCANBODY

-	30.413.005.01-2
---	-----------------

LIBRARY OPTIONS

GH = Gingival Height
CH = Cement Height
IG = Adaptor 3mm

α_s = Standard maximum angulation
 α_c = Captive maximum angulation
 α_{di} = Direct to implant maximum angulation
 α_{dp} = Dynamic Premilled maximum angulation

R = Rotational / Non-Engaging
NR = Non Rotational / Engaging

COMPATIBLE with 0246

STANDARD DYNAMIC TIBASE®

	GINGIVAL HEIGHT	α_s	α_c	GINGIVAL HEIGHT	α_s	α_c	GINGIVAL HEIGHT	α_s	α_c	GINGIVAL HEIGHT	α_s	α_c	GINGIVAL HEIGHT	α_s	α_c
	1 mm			2 mm			mm			mm			mm		
R	31.322.246.01-2	25°	-	31.322.246.02-2	25°	-	-	-	-	-	-	-	-	-	-
NR	31.312.246.01-2			31.312.246.02-2			-	-	-	-	-	-	-	-	-

DYNAMIC 3TIBASE®

GINGIVAL HEIGHT	α_s	α_s	α_s
	CH=5mm	CH= 7mm	CH= 9mm
R	-	-	-
NR	-	-	-

DYNAMIC μ SCANBODY (LAB/CLIN)

DIGITAL ANALOG

SCANBODY	HEIGHT mm	ADAPTOR	SCREWDRIVER ADAPTOR	DIGITAL ANALOG
-	-	-	-	-
-	-	-	-	-
-	-	-	-	-

DYNAMIC MILLING TOOL

DYNAMIC MILLING TOOL	SHANK	α_{di}
-	-	-
-	-	-
-	-	-

DYNAMIC SCREWS

DYNAMIC SCREW	HIGH DYNAMIC SCREW	DYNAMIC SCREWDRIVER	SCREWDRIVER LENGTH (mm)
41.318.080.01-2	-	43.618.201.01-2	18
		43.624.201.01-2	24
		43.632.201.01-2	32

STRAIGHT SCREWS

STRAIGHT SCREW	SCREWDRIVER Hex. 1.20
-	-

ANALOG

LAB SCANBODY

-	30.412.001.01-2
---	-----------------

LIBRARY OPTIONS

GH = Gingival Height
CH = Cement Height
IG = Adaptor 3mm

α_s = Standard maximum angulation
 α_c = Captive maximum angulation
 α_{di} = Direct to implant maximum angulation
 α_{dp} = Dynamic Premilled maximum angulation

R = Rotational / Non-Engaging
NR = Non Rotational / Engaging

STANDARD DYNAMIC TIBASE®															
	GINGIVAL HEIGHT	α_s	α_c	GINGIVAL HEIGHT	α_s	α_c	GINGIVAL HEIGHT	α_s	α_c	GINGIVAL HEIGHT	α_s	α_c	GINGIVAL HEIGHT	α_s	α_c
	0,3 mm			mm			mm			mm			mm		
R	31.323.247.01-2	-	-	-	40°	-	-	-	-	-	-	-	-	-	-
NR															

DYNAMIC 3TIBASE®				
GINGIVAL HEIGHT	α_s	α_s	α_s	
	CH=5mm	CH= 7mm	CH= 9mm	
-	-	-	-	
-	-	-	-	

DYNAMIC μ SCANBODY (LAB/CLIN)				DIGITAL ANALOG
SCANBODY	HEIGHT mm	ADAPTOR	SCREWDRIVER ADAPTOR	DIGITAL ANALOG
-	-	-	-	-
-	-	-	-	-

DYNAMIC MILLING TOOL		
DYNAMIC MILLING TOOL	SHANK	α_{di}
-	-	-
-	-	-
-	-	-

DYNAMIC SCREWS			
DYNAMIC SCREW	HIGH DYNAMIC SCREW	DYNAMIC SCREWDRIVER	SCREWDRIVER LENGTH (mm)
41.316.040.01-2	-	43.618.201.01-2	18
		43.624.201.01-2	24
		43.632.201.01-2	32

STRAIGHT SCREWS	
STRAIGHT SCREW	SCREWDRIVER
-	-

ANALOG	LAB SCANBODY
-	30.413.005.01-2

LIBRARY OPTIONS
GH = Gingival Height
CH = Cement Height
IG = Adaptor 3mm
 α_s = Standard maximum angulation
 α_c = Captive maximum angulation
 α_{di} = Direct to implant maximum angulation
 α_{dp} = Dynamic Premilled maximum angulation
R = Rotational / Non-Engaging
NR = Non Rotational / Engaging

STANDARD DYNAMIC TIBASE®															
	GINGIVAL HEIGHT	α_s	α_c	GINGIVAL HEIGHT	α_s	α_c	GINGIVAL HEIGHT	α_s	α_c	GINGIVAL HEIGHT	α_s	α_c	GINGIVAL HEIGHT	α_s	α_c
	1 mm			mm			mm			mm			mm		
R	31.320.249.01-2	40°	-	-	-	-	-	-	-	-	-	-	-	-	-
NR	31.310.249.01-2														

DYNAMIC 3TIBASE®				
GINGIVAL HEIGHT	α_s	α_s	α_s	
	mm	CH=5mm	CH= 7mm	CH= 9mm
R	-	-	-	-
NR	-	-	-	-

DYNAMIC μ SCANBODY (LAB/CLIN)				DIGITAL ANALOG
SCANBODY	HEIGHT mm	ADAPTOR	SCREWDRIVER ADAPTOR	DIGITAL ANALOG
52.410.128.01-2	10	50.310.249.03-2 IG=3mm	43.621.415.01-2	34.610.249.01-2
-	-			
-	-			

DYNAMIC MILLING TOOL		
DYNAMIC MILLING TOOL	SHANK	α_{di}
33.315.804.01-2	3	25°
33.415.804.01-2	4	
33.615.804.01-2	6	

DYNAMIC SCREWS			
DYNAMIC SCREW	HIGH DYNAMIC SCREW	DYNAMIC SCREWDRIVER	SCREWDRIVER LENGTH (mm)
41.314.080.01-2	-	43.618.201.01-2	18
		43.624.201.01-2	24
		43.632.201.01-2	32

STRAIGHT SCREWS	
STRAIGHT SCREW	SCREWDRIVER Hex. 1.20
-	-

ANALOG	LAB SCANBODY
-	30.410.006.01-2

LIBRARY OPTIONS
GH = Gingival Height
CH = Cement Height
IG = Adaptor 3mm
 α_s = Standard maximum angulation
 α_c = Captive maximum angulation
 α_{di} = Direct to implant maximum angulation
 α_{dp} = Dynamic Premilled maximum angulation
R = Rotational / Non-Engaging
NR = Non Rotational / Engaging

COMPATIBLE with 0251

STANDARD DYNAMIC TIBASE®															
	GINGIVAL HEIGHT	α_s	α_c	GINGIVAL HEIGHT	α_s	α_c	GINGIVAL HEIGHT	α_s	α_c	GINGIVAL HEIGHT	α_s	α_c	GINGIVAL HEIGHT	α_s	α_c
	1mm			1,5 mm			3 mm			mm			mm		
R	31.322.251.01-2	40°	-	31.322.251.02-2	40°	-	31.322.251.04-2	25°	-	-	-	-	-	-	-
NR	31.312.251.01-2			31.312.251.02-2			31.312.251.04-2			-	-	-	-	-	-

DYNAMIC 3TIBASE®				
GINGIVAL HEIGHT	α_s	α_s	α_s	
	CH=5mm	CH= 7mm	CH= 9mm	
-	-	-	-	-
-	-	-	-	-

DYNAMIC μ SCANBODY (LAB/CLIN)				DIGITAL ANALOG
SCANBODY	HEIGHT mm	ADAPTOR	SCREWDRIVER ADAPTOR	DIGITAL ANALOG
-	-	-	-	-
-	-	-	-	-

DYNAMIC MILLING TOOL		
DYNAMIC MILLING TOOL	SHANK	α_{di}
-	-	-
-	-	-
-	-	-

DYNAMIC SCREWS			
DYNAMIC SCREW	HIGH DYNAMIC SCREW	DYNAMIC SCREWDRIVER	SCREWDRIVER LENGTH (mm)
41.316.064.02-2	40.316.007.01-2	43.618.201.01-2	18
		43.624.201.01-2	24
		43.632.201.01-2	32

STRAIGHT SCREWS	
STRAIGHT SCREW	SCREWDRIVER
-	-

ANALOG	LAB SCANBODY
-	30.412.001.01-2

LIBRARY OPTIONS

GH = Gingival Height
CH = Cement Height
IG = Adaptor 3mm

α_s = Standard maximum angulation
 α_c = Captive maximum angulation
 α_{di} = Direct to implant maximum angulation
 α_{dp} = Dynamic Premilled maximum angulation

R = Rotational / Non-Engaging
NR = Non Rotational / Engaging

COMPATIBLE with 0257

STANDARD DYNAMIC TIBASE®															
	GINGIVAL HEIGHT	α_s	α_c	GINGIVAL HEIGHT	α_s	α_c	GINGIVAL HEIGHT	α_s	α_c	GINGIVAL HEIGHT	α_s	α_c	GINGIVAL HEIGHT	α_s	α_c
	1 mm			mm			mm			mm			mm		
R	-	-	-	-	-	-	-	-	-	-	-	-	-	-	-
NR	-	-	-	-	-	-	-	-	-	-	-	-	-	-	-

DYNAMIC 3TIBASE®				
GINGIVAL HEIGHT	α_s	α_s	α_s	
mm	CH=5mm	CH= 7mm	CH= 9mm	
R	-	-	-	-
NR	-	-	-	-

DYNAMIC μ SCANBODY (LAB/CLIN)				DIGITAL ANALOG
SCANBODY	HEIGHT mm	ADAPTOR	SCREWDRIVER ADAPTOR	DIGITAL ANALOG
-	-	-	-	-
-	-	-	-	-
-	-	-	-	-

DYNAMIC MILLING TOOL		
DYNAMIC MILLING TOOL	SHANK	α_{di}
-	-	-
-	-	-
-	-	-

DYNAMIC SCREWS			
DYNAMIC SCREW	HIGH DYNAMIC SCREW	DYNAMIC SCREWDRIVER	SCREWDRIVER LENGTH (mm)
41.318.065.01-2	40.318.003.01-2	-	-
		-	-
		-	-

STRAIGHT SCREWS	
STRAIGHT SCREW	SCREWDRIVER Hex. 1.20
-	43.601.103.02-2

ANALOG	LAB SCANBODY
-	-

MULTI-UNIT				
	GINGIVAL HEIGHT	GINGIVAL HEIGHT	GINGIVAL HEIGHT	GINGIVAL HEIGHT
	1 mm	2 mm	3 mm	4 mm
R	42.302.257.01-2	42.302.257.02-2	42.302.257.03-2	42.302.257.04-2

LIBRARY OPTIONS

GH = Gingival Height
CH = Cement Height
IG = Adaptor 3mm

α_s = Standard maximum angulation
 α_c = Captive maximum angulation
 α_{di} = Direct to implant maximum angulation
 α_{dp} = Dynamic Premilled maximum angulation

R = Rotational / Non-Engaging
NR = Non Rotational / Engaging

STANDARD DYNAMIC TIBASE®															
	GINGIVAL HEIGHT	α_s	α_c	GINGIVAL HEIGHT	α_s	α_c	GINGIVAL HEIGHT	α_s	α_c	GINGIVAL HEIGHT	α_s	α_c	GINGIVAL HEIGHT	α_s	α_c
	0,5 mm			mm			mm			mm			mm		
R	31.320.260.01-2	40°	-	-	-	-	-	-	-	-	-	-	-	-	-
NR	31.310.260.01-2		-	-	-	-	-	-	-	-	-	-	-	-	-

DYNAMIC 3TIBASE®				
	GINGIVAL HEIGHT	α_s	α_s	α_s
	mm	CH=5mm	CH= 7mm	CH= 9mm
R	-	-	-	-
NR	-	-	-	-

DYNAMIC μ SCANBODY (LAB/CLIN)				DIGITAL ANALOG
SCANBODY	HEIGHT mm	ADAPTOR	SCREWDRIVER ADAPTOR	DIGITAL ANALOG
52.410.103.01-2	10	50.310.207.03-2 IG=3mm	43.621.410.01-2 43.624.410.01-2	34.610.260.01-2
52.412.103.01-2	12			

DYNAMIC MILLING TOOL		
DYNAMIC MILLING TOOL	SHANK	α_{di}
33.345.856.01-2	3	25°
33.445.856.01-2	4	
33.645.856.01-2	6	

DYNAMIC SCREWS			
DYNAMIC SCREW	HIGH DYNAMIC SCREW	DYNAMIC SCREWDRIVER	SCREWDRIVER LENGTH (mm)
41.316.066.01-2	-	43.618.201.01-2	18
		43.624.201.01-2	24
		43.632.201.01-2	32

STRAIGHT SCREWS	
STRAIGHT SCREW	SCREWDRIVER Hex. 1.20
-	-

ANALOG	LAB SCANBODY
-	30.410.006.01-2

MULTI-UNIT				
	GINGIVAL HEIGHT	GINGIVAL HEIGHT	GINGIVAL HEIGHT	GINGIVAL HEIGHT
	1 mm	2 mm	3 mm	4 mm
R	42.302.207.01-2	42.302.207.02-2	42.302.207.03-2	42.302.207.04-2

LIBRARY OPTIONS
GH = Gingival Height
CH = Cement Height
IG = Adaptor 3mm
 α_s = Standard maximum angulation
 α_c = Captive maximum angulation
 α_{di} = Direct to implant maximum angulation
 α_{dp} = Dynamic Premilled maximum angulation
R = Rotational / Non-Engaging
NR = Non Rotational / Engaging

STANDARD DYNAMIC TIBASE®															
	GINGIVAL HEIGHT	α_s	α_c	GINGIVAL HEIGHT	α_s	α_c	GINGIVAL HEIGHT	α_s	α_c	GINGIVAL HEIGHT	α_s	α_c	GINGIVAL HEIGHT	α_s	α_c
	0,5 mm			mm			mm			mm			mm		
R	31.323.261.01-2	40°	-	-	-	-	-	-	-	-	-	-	-	-	-
NR	31.313.261.01-2		-	-	-	-	-	-	-	-	-	-	-	-	-

DYNAMIC 3TIBASE®				
	GINGIVAL HEIGHT	α_s	α_s	α_s
	mm	CH=5mm	CH= 7mm	CH= 9mm
R	-	-	-	-
NR	-	-	-	-

DYNAMIC μ SCANBODY (LAB/CLIN)				DIGITAL ANALOG
SCANBODY	HEIGHT mm	ADAPTOR	SCREWDRIVER ADAPTOR	DIGITAL ANALOG
52.410.103.01-2	10	50.310.207.03-2 IG=3mm	43.621.410.01-2 43.624.410.01-2	34.613.261.01-2
52.412.103.01-2	12			

DYNAMIC MILLING TOOL		
DYNAMIC MILLING TOOL	SHANK	α_{di}
33.345.856.01-2	3	25°
33.445.856.01-2	4	
33.645.856.01-2	6	

DYNAMIC SCREWS			
DYNAMIC SCREW	HIGH DYNAMIC SCREW	DYNAMIC SCREWDRIVER	SCREWDRIVER LENGTH (mm)
41.316.066.01-2	-	43.618.201.01-2	18
		43.624.201.01-2	24
		43.632.201.01-2	32

STRAIGHT SCREWS	
STRAIGHT SCREW	SCREWDRIVER Hex. 1.20
-	-

ANALOG	LAB SCANBODY
-	30.413.004.01-2

MULTI-UNIT				
	GINGIVAL HEIGHT	GINGIVAL HEIGHT	GINGIVAL HEIGHT	GINGIVAL HEIGHT
	1 mm	2 mm	3 mm	4 mm
R	42.302.207.01-2	42.302.207.02-2	42.302.207.03-2	42.302.207.04-2

LIBRARY OPTIONS
GH = Gingival Height
CH = Cement Height
IG = Adaptor 3mm
 α_s = Standard maximum angulation
 α_c = Captive maximum angulation
 α_{di} = Direct to implant maximum angulation
 α_{dp} = Dynamic Premilled maximum angulation
R = Rotational / Non-Engaging
NR = Non Rotational / Engaging

STANDARD DYNAMIC TIBASE®															
	GINGIVAL HEIGHT	α_s	α_c	GINGIVAL HEIGHT	α_s	α_c	GINGIVAL HEIGHT	α_s	α_c	GINGIVAL HEIGHT	α_s	α_c	GINGIVAL HEIGHT	α_s	α_c
	0,5 mm			mm			mm			mm			mm		
R	31.324.262.01-2	40°	-	-	-	-	-	-	-	-	-	-	-	-	-
NR	31.314.262.01-2		-	-	-	-	-	-	-	-	-	-	-	-	-

DYNAMIC 3TIBASE®				
	GINGIVAL HEIGHT	α_s	α_s	α_s
	mm	CH=5mm	CH= 7mm	CH= 9mm
R	-	-	-	-
NR	-	-	-	-

DYNAMIC μSCANBODY (LAB/CLIN)				DIGITAL ANALOG
SCANBODY	HEIGHT mm	ADAPTOR	SCREWDRIVER ADAPTOR	DIGITAL ANALOG
52.410.103.01-2	10	50.310.207.03-2 IG=3mm	43.621.410.01-2 43.624.410.01-2	34.614.262.01-2
52.412.103.01-2	12			

DYNAMIC MILLING TOOL		
DYNAMIC MILLING TOOL	SHANK	α_{di}
33.345.856.01-2	3	25°
33.445.856.01-2	4	
33.645.856.01-2	6	

DYNAMIC SCREWS			
DYNAMIC SCREW	HIGH DYNAMIC SCREW	DYNAMIC SCREWDRIVER	SCREWDRIVER LENGTH (mm)
41.316.066.01-2	-	43.618.201.01-2	18
		43.624.201.01-2	24
		43.632.201.01-2	32

STRAIGHT SCREWS	
STRAIGHT SCREW	SCREWDRIVER Hex. 1.20
-	-

ANALOG	LAB SCANBODY
-	30.414.008.01-2

MULTI-UNIT				
	GINGIVAL HEIGHT	GINGIVAL HEIGHT	GINGIVAL HEIGHT	GINGIVAL HEIGHT
	1 mm	2 mm	3 mm	4 mm
R	42.302.207.01-2	42.302.207.02-2	42.302.207.03-2	42.302.207.04-2

LIBRARY OPTIONS
GH = Gingival Height
CH = Cement Height
IG = Adaptor 3mm
 α_s = Standard maximum angulation
 α_c = Captive maximum angulation
 α_{di} = Direct to implant maximum angulation
 α_{dp} = Dynamic Premilled maximum angulation
R = Rotational / Non-Engaging
NR = Non Rotational / Engaging

STANDARD DYNAMIC TIBASE®															
	GINGIVAL HEIGHT	α_s	α_c	GINGIVAL HEIGHT	α_s	α_c	GINGIVAL HEIGHT	α_s	α_c	GINGIVAL HEIGHT	α_s	α_c	GINGIVAL HEIGHT	α_s	α_c
	mm			mm			mm			mm			mm		
R	-	-	-	-	-	-	-	-	-	-	-	-	-	-	-
NR	-	-	-	-	-	-	-	-	-	-	-	-	-	-	-

DYNAMIC 3TIBASE®				
	GINGIVAL HEIGHT	α_s	α_s	α_s
	0,3 mm	CH=5mm	CH= 7mm	CH= 9mm
R	31.323.264.21-2	25°	25°	25°
NR	-			

DYNAMIC μSCANBODY (LAB/CLIN)				DIGITAL ANALOG
SCANBODY	HEIGHT mm	ADAPTOR	SCREWDRIVER ADAPTOR	DIGITAL ANALOG
-	-	-	-	-
-	-			

DYNAMIC MILLING TOOL		
DYNAMIC MILLING TOOL	SHANK	α_{di}
-	-	-
-	-	
-	-	

DYNAMIC SCREWS			
DYNAMIC SCREW	HIGH DYNAMIC SCREW	DYNAMIC SCREWDRIVER	SCREWDRIVER LENGTH (mm)
41.314.044.02-2	-	43.618.201.01-2	18
		43.624.201.01-2	24
		43.632.201.01-2	32

STRAIGHT SCREWS	
STRAIGHT SCREW	SCREWDRIVER -
-	-

ANALOG	LAB SCANBODY
-	-

LIBRARY OPTIONS
GH = Gingival Height
CH = Cement Height
IG = Adaptor 3mm
 α_s = Standard maximum angulation
 α_c = Captive maximum angulation
 α_{di} = Direct to implant maximum angulation
 α_{dp} = Dynamic Premilled maximum angulation
R = Rotational / Non-Engaging
NR = Non Rotational / Engaging

STANDARD DYNAMIC TIBASE®															
	GINGIVAL HEIGHT	α_s	α_c	GINGIVAL HEIGHT	α_s	α_c	GINGIVAL HEIGHT	α_s	α_c	GINGIVAL HEIGHT	α_s	α_c	GINGIVAL HEIGHT	α_s	α_c
	0,5 mm			mm			mm			mm			mm		
R	31.320.266.01-2	35°	-	-	-	-	-	-	-	-	-	-	-	-	-
NR	31.310.266.01-2		-	-	-	-	-	-	-	-	-	-	-	-	-

DYNAMIC 3TIBASE®				
	GINGIVAL HEIGHT	α_s	α_s	α_s
	mm	CH=5mm	CH= 7mm	CH= 9mm
R	-	-	-	-
NR	-	-	-	-

DYNAMIC μSCANBODY (LAB/CLIN)				DIGITAL ANALOG
SCANBODY	HEIGHT mm	ADAPTOR	SCREWDRIVER ADAPTOR	DIGITAL ANALOG
-	-	-	-	-
-	-	-	-	-

DYNAMIC MILLING TOOL		
DYNAMIC MILLING TOOL	SHANK	α_{di}
-	-	-
-	-	-

DYNAMIC SCREWS			
DYNAMIC SCREW	HIGH DYNAMIC SCREW	DYNAMIC SCREWDRIVER	SCREWDRIVER LENGTH (mm)
41.320.068.01-2	-	43.618.201.01-2	18
		43.624.201.01-2	24
		43.632.201.01-2	32

STRAIGHT SCREWS	
STRAIGHT SCREW	SCREWDRIVER Hex. 1.20
-	-

ANALOG	LAB SCANBODY
-	30.410.006.01-2

LIBRARY OPTIONS

GH = Gingival Height
CH = Cement Height
IG = Adaptor 3mm

α_s = Standard maximum angulation
 α_c = Captive maximum angulation
 α_{di} = Direct to implant maximum angulation
 α_{dp} = Dynamic Premilled maximum angulation

R = Rotational / Non-Engaging
NR = Non Rotational / Engaging

STANDARD DYNAMIC TIBASE®															
	GINGIVAL HEIGHT	α_s	α_c	GINGIVAL HEIGHT	α_s	α_c	GINGIVAL HEIGHT	α_s	α_c	GINGIVAL HEIGHT	α_s	α_c	GINGIVAL HEIGHT	α_s	α_c
	0,5 mm			mm			mm			mm			mm		
R	31.322.267.01-2	40°	-	-	-	-	-	-	-	-	-	-	-	-	-
NR	31.312.267.01-2		-	-	-	-	-	-	-	-	-	-	-	-	-

DYNAMIC 3TIBASE®				
	GINGIVAL HEIGHT	α_s	α_s	α_s
	mm	CH=5mm	CH= 7mm	CH= 9mm
-	-	-	-	-
-	-	-	-	-

DYNAMIC μSCANBODY (LAB/CLIN)				DIGITAL ANALOG
SCANBODY	HEIGHT mm	ADAPTOR	SCREWDRIVER ADAPTOR	DIGITAL ANALOG
-	-	-	-	-
-	-	-	-	-

DYNAMIC MILLING TOOL		
DYNAMIC MILLING TOOL	SHANK	α_{di}
-	-	-
-	-	-

DYNAMIC SCREWS			
DYNAMIC SCREW	HIGH DYNAMIC SCREW	DYNAMIC SCREWDRIVER	SCREWDRIVER LENGTH (mm)
41.320.068.01-2	-	43.618.201.01-2	18
		43.624.201.01-2	24
		43.632.201.01-2	32

STRAIGHT SCREWS	
STRAIGHT SCREW	SCREWDRIVER TORX T6
40.320.007.02-2	43.601.107.01-2

ANALOG	LAB SCANBODY
-	30.412.001.01-2

LIBRARY OPTIONS

GH = Gingival Height
CH = Cement Height
IG = Adaptor 3mm

α_s = Standard maximum angulation
 α_c = Captive maximum angulation
 α_{di} = Direct to implant maximum angulation
 α_{dp} = Dynamic Premilled maximum angulation

R = Rotational / Non-Engaging
NR = Non Rotational / Engaging

STANDARD DYNAMIC TIBASE®															
	GINGIVAL HEIGHT	α_s	α_c	GINGIVAL HEIGHT	α_s	α_c	GINGIVAL HEIGHT	α_s	α_c	GINGIVAL HEIGHT	α_s	α_c	GINGIVAL HEIGHT	α_s	α_c
	0,5 mm			mm			mm			mm			mm		
R	31.320.268.01-2	45°	-	-	-	-	-	-	-	-	-	-	-	-	-
NR	31.310.268.01-2		-	-	-	-	-	-	-	-	-	-	-	-	-

DYNAMIC 3TIBASE®				
	GINGIVAL HEIGHT	α_s	α_s	α_s
	mm	CH=5mm	CH= 7mm	CH= 9mm
R	-	-	-	-
NR	-	-	-	-

DYNAMIC μ SCANBODY (LAB/CLIN)				DIGITAL ANALOG
SCANBODY	HEIGHT mm	ADAPTOR	SCREWDRIVER ADAPTOR	DIGITAL ANALOG
-	-	-	-	-
-	-	-	-	-

DYNAMIC MILLING TOOL		
DYNAMIC MILLING TOOL	SHANK	α_{di}
-	-	-
-	-	-
-	-	-

DYNAMIC SCREWS			
DYNAMIC SCREW	HIGH DYNAMIC SCREW	DYNAMIC SCREWDRIVER	SCREWDRIVER LENGTH (mm)
41.320.068.01-2	-	43.618.201.01-2	18
		43.624.201.01-2	24
		43.632.201.01-2	32

STRAIGHT SCREWS	
STRAIGHT SCREW	SCREWDRIVER Hex. 1.20
-	-

ANALOG	LAB SCANBODY
-	30.413.002.01-2

LIBRARY OPTIONS
GH = Gingival Height
CH = Cement Height
IG = Adaptor 3mm
 α_s = Standard maximum angulation
 α_c = Captive maximum angulation
 α_{di} = Direct to implant maximum angulation
 α_{op} = Dynamic Premilled maximum angulation
R = Rotational / Non-Engaging
NR = Non Rotational / Engaging

LIBRARY CODES

LAB SCANBODY	DAS_E_XXXX*	MULTI-UNIT DYNAMIC SCANBODY	DAS_MU_I_XXXX*_PREMIUM DAS_MU_IG_XXXX*_PREMIUM
DYNAMIC μSCANBODY	DAS_I_10_XXXX* DAS_IG_10_XXXX*	DAS MULTI-UNIT SCANALOG	DAS_MU_SA_XXXX*_PREMIUM
SCANALOG	DAS_SA_XXXX*	DAS MULTI-UNIT SCANBODY	DAS_MU_4.5_XXXX*_PREMIUM DAS_MU_8_XXXX*_PREMIUM DAS_MU_DS8_XXXX*_PREMIUM
REFERENCE SCANBODY	DAS_R_XXXX*		

*XXXX= compatibility code (ex.0256)

DYNAMIC SCREWS TECHNICAL SPECIFICATIONS

REFERENCE	METRIC	TORQUE	TOTAL LENGTH	THREAD LENGTH	A LENGTH	B LENGTH	C LENGTH	HEAD DIAMETER	SEAT	ANGLE	THREAD ENTRY	CONNECTION
41.312.078.01-2	1,2	15 N-cm	7,8	2,65	6	6,55	1,25	2,3	conical	45°	45° Chamfer	HEXALOBULAR 1,70
41.314.039.01-2	1,4	15 N-cm	3,9	1,8	2,1	-	1,8	2,4	straight	-	45° Chamfer	
41.314.040.01-2	1,4	15 N-cm	4	1,85	2	2,78	1,22	2,3	conical	30°	45° Chamfer	
41.314.040.02-2	1,4	15 N-cm	4	1,7	2,25	2,7	1,3	2,3	conical	45°	45° Chamfer	
41.314.043.01-2	1,4	15 N-cm	4,3	1,8	2,03	2,9	1,4	2,3	conical	35°	45° Chamfer	
41.314.044.01-2	1,4	15 N-cm	4,4	2,15	2,73	3	1,4	2,3	conical	60°	45° Chamfer	
41.314.044.02-2	1,4	15 N-cm	4,4	2	2,6	-	1,8	2,3	straight	-	45° Chamfer	
41.314.045.01-2	1,4	15 N-cm	4,5	2,3	2,5	3,28	1,22	2,3	conical	30°	45° Chamfer	
41.314.046.01-2	1,4	15 N-cm	4,6	2,5	4,6	3,17	1,43	2,3	conical	35°	45° Chamfer	
41.314.052.01-2	1,4	15 N-cm	5,2	2,9	3,4	-	1,8	2,3	straight	-	45° Chamfer	
41.314.064.01-2	1,4	15 N-cm	6,4	2,2	4,21	5,15	1,25	2,3	conical	25°	45° Chamfer	
41.314.067.01-2	1,4	15 N-cm	6,7	2,31	5	5,45	1,25	2,3	conical	45°	45° Chamfer	
41.314.067.02-2	1,4	15 N-cm	6,7	2,5	4,71	5,5	1,2	2,3	conical	35°	45° Chamfer	
41.314.070.01-2	1,4	15 N-cm	7	2,3	5,39	5,65	1,61	2,3	conical	60°	45° Chamfer	
41.314.074.01-2	1,4	15 N-cm	7,4	3,55	5	5,99	1,41	2,3	conical	25°	45° Chamfer	
41.314.076.01-2	1,4	15 N-cm	7,6	2,4	5,9	6,35	1,25	2,3	conical	45°	45° Chamfer	
41.314.080.01-2	1,4	15 N-cm	8	2,1	4,96	6,8	1,2	2,3	conical	15°	45° Chamfer	
41.314.084.01-2	1,4	15 N-cm	8,4	2,5	5,92	6,85	1,55	2,3	conical	35°	45° Chamfer	
41.314.105.01-2	1,4	15 N-cm	10,5	2,31	5	5,45	5,05	2,3	conical	45°	45° Chamfer	
41.315.078.01-2	N0-80	15 N-cm	7,8	2,45	5,77	6	1,8	2,3	conical	65°	45° Chamfer	
41.315.040.01-2	1,6	20 N-cm	4	2,07	2,3	2,47	1,53	2,3	conical	65°	45° Chamfer	
41.316.044.01-2	1,6	20 N-cm	4,4	2,5	2,9	-	1,5	2,3	straight	-	Semi-sphere	
41.316.048.01-2	1,6	20 N-cm	4,8	2,4	2,93	1,87	1,3	2,3	conical	45°	45° Chamfer	
41.316.048.02-2	1,6	20 N-cm	4,8	2,4	3	3,58	1,22	2,3	conical	31°	45° Chamfer	
41.316.055.01-2	1,6	20 N-cm	5,5	2,4	2,85	4,2	1,3	2,3	conical	23°	45° Chamfer	
41.316.059.01-2	1,6	20 N-cm	5,9	3	4,4	-	1,5	2,3	straight	-	Semi-sphere	
41.316.064.01-2	1,6	20 N-cm	6,4	3,15	4,7	5	1,4	2,3	conical	60°	45° Chamfer	

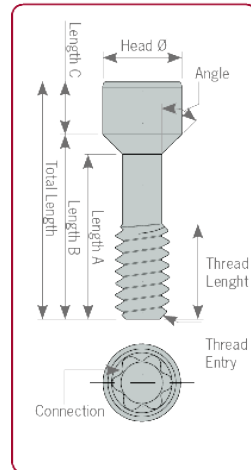
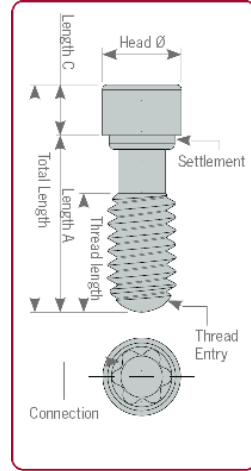

REFERENCE	METRIC	TORQUE	TOTAL LENGTH	THREAD LENGTH	A LENGTH	B LENGTH	C LENGTH	HEAD DIAMETER	SEAT	ANGLE	THREAD ENTRY	CONNECTION
41.316.066.01-2	1,6	20 N-cm	6,6	1,9	4,7	5,2	1,9	2,3	conical	45°	45° Chamfer	HEXALOBULAR 1,70
41.316.071.01-2	1,6	20 N-cm	7,1	2,8	5,2	5,53	1,57	2,3	conical	60°	45° Chamfer	
41.316.072.01-2	1,6	20 N-cm	7,2	3,5	5,2	5,85	1,35	2,3	conical	30°	45° Chamfer	
41.316.073.01-2	1,6	20 N-cm	7,3	2,2	4,87	5,56	1,74	2,3	conical	35°	45° Chamfer	
41.316.074.01-2	1,6	20 N-cm	7,4	2,7	5,5	6	1,4	2,3	conical	45°	45° Chamfer	
41.316.076.01-2	1,6	20 N-cm	7,6	3,6	6,1	-	1,5	2,3	straight	-	Semi-sphere	
41.316.078.01-2	1,6	20 N-cm	7,8	2	5,36	7,03	0,81	2,3	conical	15°	45° Chamfer	
41.316.079.01-2	1,6	20 N-cm	7,9	2,30	5,42	6,60	1,3	2,3	conical	20°	45° Chamfer	
41.316.079.02-2	1,6	20 N-cm	7,9	3,9	6,3	-	1,6	2,3	straight	-	45° Chamfer	
41.316.080.01-2	1,6	20 N-cm	8	3,14	6,3	6,51	1,49	2,3	conical	60°	45° Chamfer	
41.316.081.01-2	1,6	20 N-cm	8,1	3	6,35	6,72	1,38	2,3	conical	45°	45° Chamfer	
41.316.084.01-2	1,6	20 N-cm	8,4	3,5	6,8	-	1,6	2,3	straight	-	Semi-sphere	
41.316.084.02-2	1,6	20 N-cm	8,4	2,7	5,85	6,85	1,55	2,3	conical	30°	45° Chamfer	
41.316.086.01-2	1,6	20 N-cm	8,6	3	7,2	-	1,4	2,3	straight	-	45° Chamfer	
41.316.094.01-2	1,6	20 N-cm	9,4	2,9	7,65	8	1,4	2,3	conical	45°	45° Chamfer	
41.316.108.01-2	1,6	20 N-cm	10,8	2	5,36	7,03	0,81	2,3	conical	15°	45° Chamfer	
41.316.115.01-2	1,6	20 N-cm	11,5	3,5	5,2	5,85	6,3	2,3	conical	30°	45° Chamfer	
41.316.118.01-2	1,6	20 N-cm	11,8	3,6	6,1	-	5,7	2,3	straight	-	Semi-sphere	
41.316.124.01-2	1,6	20 N-cm	12,4	2,2	4,74	5,56	5,24	2,3	conical	35°	45° Chamfer	
41.316.132.01-2	1,6	20 N-cm	13,2	2,9	7,62	8	5,2	2,3	conical	45°	45° Chamfer	
41.317.040.01-2	N1-72	25 N-cm	4	2,1	2,5	-	1,5	2,3	straight	-	45° Chamfer	
41.317.041.01-2	N1-72	25 N-cm	4,1	1,9	2,3	2,67	1,43	2,3	conical	55°	45° Chamfer	
41.317.065.01-2	N1-72	25 N-cm	6,5	2,4	4,7	5,18	1,33	2,3	conical	45°	45° Chamfer	
41.317.070.01-2	N1-72	25 N-cm	7	2,2	4,96	5,8	1,2	2,3	conical	30°	45° Chamfer	
41.317.071.01-2	N1-72	25 N-cm	7,1	2,5	5,56	5,65	1,45	2,3	conical	70°	45° Chamfer	
41.317.072.01-2	N1-72	25 N-cm	7,2	2,5	5,5	5,77	1,43	2,3	conical	60°	45° Chamfer	
41.317.073.01-2	N1-72	25 N-cm	7,3	2,5	5,5	5,77	1,53	2,3	conical	60°	45° Chamfer	
41.317.106.01-2	N1-72	25 N-cm	10,6	2,6	5,54	5,65	4,95	2,3	conical	70°	Semi-sphere	
41.318.043.01-2	1,8	25 N-cm	4,3	2	2,52	2,7	1,6	2,3	conical	55°	45° Chamfer	



DYNAMIC SCREWS TECHNICAL SPECIFICATIONS

REFERENCE	METRIC	TORQUE	TOTAL LENGTH	THREAD LENGTH	A LENGTH	B LENGTH	C LENGTH	HEAD DIAMETER	SEAT	ANGLE	THREAD ENTRY	CONNECTION
41.318.044.01-2	1,8	25 N-cm	4,4	2,75	3	-	1,4	2,3	straight	-	Semi-sphere	Hexalobular 1,70
41.318.045.01-2	1,8	25 N-cm	4,5	2,3	2,81	2,9	1,6	2,3	conical	70°	45° Chamfer	
41.318.048.01-2	1,8	25 N-cm	4,8	2,8	3,22	3,65	1,15	2,3	conical	30°	Semi-sphere	
41.318.051.01-2	1,8	25 N-cm	5,1	2,7	3,55	3,7	1,4	2,3	conical	60°	45° Chamfer	
41.318.051.02-2	1,8	25 N-cm	5,1	2,7	3,55	3,7	1,4	2,3	conical	45°	45° Chamfer	
41.318.064.01-2	1,8	25 N-cm	6,4	3,45	4,73	5,1	1,3	2,3	conical	35°	45° Chamfer	
41.318.065.01-2	1,8	25 N-cm	6,5	2,8	5	-	1,5	2,3	straight	-	Semi-sphere	
41.318.067.01-2	1,8	25 N-cm	6,7	2,35	5	5,4	1,3	2,3	conical	45°	45° Chamfer	
41.318.068.01-2	1,8	25 N-cm	6,8	4	5,25	5,4	1,4	2,3	conical	60°	45° Chamfer	
41.318.071.01-2	1,8	25 N-cm	7,1	2,6	5,56	5,65	1,45	2,3	conical	70°	45° Chamfer	
41.318.074.01-2	1,8	25 N-cm	7,4	3,8	5,8	6,03	1,6	2,3	conical	50°	45° Chamfer	
41.318.075.01-2	1,8	25 N-cm	7,5	3,3	6,1	-	1,4	2,3	straight	-	Semi-sphere	
41.318.076.01-2	1,8	25 N-cm	7,6	2,52	5,8	6,2	1,4	2,3	conical	45°	45° Chamfer	
41.318.077.02-2	1,8	25 N-cm	7,7	2	6,09	6,35	1,35	2,3	conical	60°	45° Chamfer	
41.318.080.01-2	1,8	25 N-cm	8	4	6,5	-	1,5	2,3	straight	-	45° Chamfer	
41.318.083.01-2	1,8	25 N-cm	8,3	4,25	6,79	6,95	1,35	2,3	conical	60°	45° Chamfer	
41.320.038.01-2	2	25 N-cm	3,81	1,6	3,25	2,35	1,39	2,35	conical	70°	20° Chamfer	
41.320.044.01-2	2	25 N-cm	4,4	2,45	2,45	3,1	1,3	2,3	conical	45°	45° Chamfer	
41.320.047.01-2	2	25 N-cm	4,7	3	3,3	-	1,4	2,3	straight	-	Semi-sphere	
41.320.048.01-2	2	25 N-cm	4,8	2,7	3,3	3,4	1,4	2,3	conical	60°	45° Chamfer	
41.320.050.01-2	2	25 N-cm	5	2,8	3,39	3,6	1,4	2,3	conical	30°	Semi-sphere	
41.320.051.01-2	2	25 N-cm	5,1	3,1	3,6	-	1,5	2,3	straight	-	Semi-sphere	
41.320.060.01-2	2	25 N-cm	6	2,7	4,5	-	1,5	2,3	straight	-	Semi-sphere	
41.320.065.01-2	2	25 N-cm	6,5	2,7	5	-	1,5	2,3	straight	-	45° Chamfer	
41.320.067.01-2	2	25 N-cm	6,7	2,3	3,65	5,68	1,02	2,58	conical	15°	45° Chamfer	
41.320.068.01-2	2	25 N-cm	6,8	4,4	5,3	5,4	1,4	2,3	conical	60°	45° Chamfer	

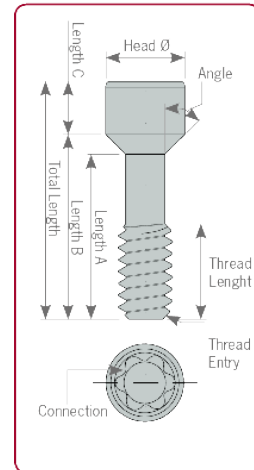
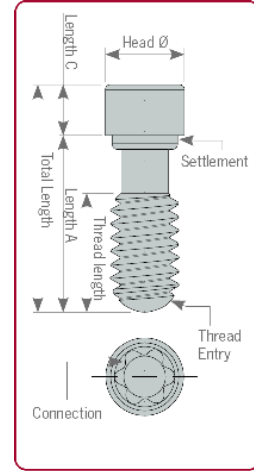

REFERENCE	METRIC	TORQUE	TOTAL LENGTH	THREAD LENGTH	A LENGTH	B LENGTH	C LENGTH	HEAD DIAMETER	SEAT	ANGLE	THREAD ENTRY	CONNECTION
41.320.070.01-2	2	25 N-cm	7	3	5,6	-	1,4	2,3	straight	-	Semi-sphere	Hexalobular 1,70
41.320.074.01-2	2	25 N-cm	7,4	3,3	6	-	1,4	2,3	straight	-	Semi-sphere	
41.320.075.01-2	2	25 N-cm	7,5	2,75	5,93	6,18	1,32	2,3	conical	35°	45° Chamfer	
41.320.079.01-2	2	25 N-cm	7,9	3,3	6,33	6,5	1,4	2,3	conical	45°	45° Chamfer	
41.320.082.01-2	2	25 N-cm	8,2	4,7	6,7	-	1,5	2,4	straight	-	Semi-sphere	
41.320.090.01-2	2	25 N-cm	9	4	7,5	-	1,5	2,3	straight	-	Semi-sphere	
41.320.094.01-2	2	25 N-cm	9,4	3	7,85	8	1,4	2,3	conical	45°	45° Chamfer	
41.320.117.01-2	2	25 N-cm	11,7	2,75	5,9	6,18	5,52	2,3	conical	35°	Semi-sphere	
41.320.125.01-2	2	25 N-cm	12,5	3,3	6,33	6,5	6	2,3	conical	45°	45° Chamfer	
41.320.129.01-2	2	25 N-cm	12,9	4,7	6,7	-	6,2	2,4	straight	-	Semi-sphere	
41.320.137.01-2	2	25 N-cm	13,7	4	12,2	-	1,5	2,3	straight	-	Semi-sphere	
41.325.054.01-2	2,5	25 N-cm	5,4	3,8	4,1	-	1,3	2,85	straight	-	Semi-sphere	
41.325.067.01-2	2,5	25 N-cm	6,7	4,6	5,1	-	1,6	2,85	straight	-	Semi-sphere	

DYNAMIC SCREWDRIVER & DYNAMIC SCREWS

Dynamic Screwdrivers

Screwdriver with hexalobular head, exclusively to the 3.0 Dynamic Abutment® system.

Lengths:
18, 24, 32mm.



Dynamic Screws are used with the Dynamic TiBase® or milled structures with an angled screw channel.
Made of Titanium grade V.



High Dynamic Screw

Dynamic Screw



Dynamic Screw Transfer
49.413.000.01-2

STRAIGHT SCREWS TECHNICAL SPECIFICATIONS

REFERENCE	METRIC	TORQUE	TOTAL LENGTH	THREAD LENGTH	A LENGTH	B LENGTH	C LENGTH	HEAD DIAMETER	SEAT	ANGLE	THREAD ENTRY	CONNECTION
40.312.003.01-2	1,2	15 N-cm	7,85	2,7	6,19	6,55	1,3	1,9	conical	45°	45° Chamfer	Hex. 1,20
40.314.003.01-2	1,4	15 N-cm	3,9	1,91	2,1	-	1,8	2,4	straight	-	45° Chamfer	Hex. 1,20
40.314.003.02-2	1,4	15 N-cm	4	2	2,2	-	1,8	2,3	straight	-	45° Chamfer	Hex. 1,20
40.314.003.03-2	1,4	15 N-cm	7,6	2,4	6,05	6,3	1,3	1,9	conical	45°	45° Chamfer	Hex. 1,20
40.314.003.04-2	1,4	15 N-cm	7,5	2,5	5,45	5,7	1,8	1,85	conical	45°	45° Chamfer	Hex. 1,20
40.314.004.01-2	1,4	15 N-cm	6,3	1,7	4,6	5,1	1,2	2,1	conical	25°	30° Chamfer	Hex. 1,25
40.314.004.02-2	1,4	15 N-cm	8,4	2,5	5,99	6,7	1,7	2	conical	35°	45° Chamfer	Hex. 1,25
40.314.004.03-2	1,4	15 N-cm	4,3	1,8	2,3	-	2	2	straight	-	45° Chamfer	Hex. 1,25
40.314.005.01-2	1,4	15 N-cm	7,6	3,55	5,17	6	1,6	2,15	conical	25°	45° Chamfer	Hex. 1,27
40.314.005.02-2	1,4	15 N-cm	7,5	2,5	5,5	5,7	1,7	2,1	conical	60°	45° Chamfer	Hex. 1,27
40.314.005.04-2	1,4	15 N-cm	4	1,70	2,25	-	1,75	2,10	straight	-	45° Chamfer	Hex. 1,27
40.314.007.01-2	1,4	15 N-cm	4	1,8	2,01	2,8	1,2	2,2	conical	35°	45° Chamfer	Torx T6
40.314.007.02-2	1,4	15 N-cm	7	2,1	4,75	2,25	0,8	2,1	conical	15°	45° Chamfer	Torx T6
40.314.008.01-2	1,4	15 N-cm	3,5	1,8	2,1	-	1,4	2	straight	-	45° Chamfer	Unigrip
40.314.008.02-2	1,4	15 N-cm	6,7	2,5	4,87	5,3	1,4	1,8	conical	35°	45° Chamfer	Unigrip
40.314.012.01-2	1,4	15 N-cm	4,5	1,7	2,01	2,4	2,1	2,15	conical	45°	45° Chamfer	Star 1,50
40.314.014.01-2	1,4	15 N-cm	4,45	2	2,48	-	1,97	2,16	straight	-	45° Chamfer	Hex. 1,19
40.316.002.01-2	1,6	20 N-cm	7	2,79	4,86	5,44	1,56	2,3	conical	45°	45° Chamfer	Sq. 1,30
40.316.002.02-2	1,6	20 N-cm	9,3	3,3	7,3	-	2	2,3	straight	-	Semi-sphere	Sq. 1,30
40.316.003.01-2	1,6	20 N-cm	8,4	2,5	6,6	-	1,8	2	straight	-	45° Chamfer	Hex. 1,20
40.316.003.02-2	1,6	20 N-cm	10,2	2	7,88	8,2	2	2,2	conical	45°	45° Chamfer	Hex. 1,20
40.316.004.01-2	1,6	20 N-cm	8,6	2,7	6,16	6,9	1,7	2	conical	30°	45° Chamfer	Hex. 1,25
40.316.004.02-2	1,6	20 N-cm	8,8	3	6,73	6,8	1,8	2,1	conical	45°	45° Chamfer	Hex. 1,25
40.316.004.03-2	1,6	20 N-cm	6,9	2,2	5,02	5,2	1,7	1,92	conical	60°	45° Chamfer	Hex. 1,25
40.316.005.01-2	1,6	20 N-cm	7,5	3,6	5,33	5,85	1,65	2,15	conical	30°	45° Chamfer	Hex. 1,27
40.316.005.02-2	1,6	20 N-cm	8,2	3,03	6,25	-	2	2,33	straight	-	45° Chamfer	Hex. 1,27
40.316.005.04-2	1,6	20 N-cm	10,5	2,9	8,15	8,4	2,1	2,1	conical	45°	45° Chamfer	Hex. 1,27

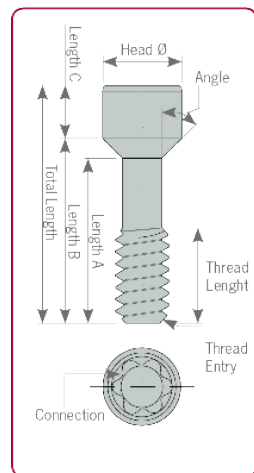
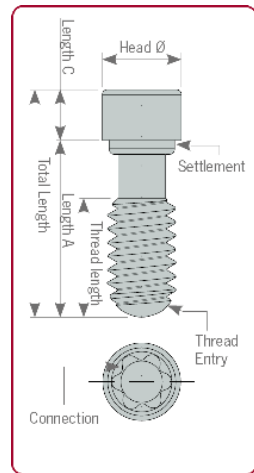

REFERENCE	METRIC	TORQUE	TOTAL LENGTH	THREAD LENGTH	A LENGTH	B LENGTH	C LENGTH	HEAD DIAMETER	SEAT	ANGLE	THREAD ENTRY	CONNECTION
40.316.005.05-2	1,6	20 N-cm	7,6	2,7	5,21	5,5	2,1	2,1	conical	60°	45° Chamfer	Hex. 1,27
40.316.005.06-2	1,6	20 N-cm	3,6	1,8	2,2	-	1,4	2,1	straight	-	45° Chamfer	Hex. 1,27
40.316.005.07-2	1,6	20 N-cm	8,8	2,85	6,73	6,9	1,9	2,15	conical	60	45° Chamfer	Hex. 1,27
40.316.005.08-2	1,6	20 N-cm	9	3,9	0	6,9	2,1	2,18	conical	45°	45° Chamfer	Hex. 1,27
40.316.007.01-2	1,6	20 N-cm	7,9	2	5,72	6,9	2,18	2,18	conical	15°	45° Chamfer	Torx T6
40.316.008.01-2	1,6	20 N-cm	7	2,7	5,15	-	1,8	2,3	straight	-	45° Chamfer	Unigrip
40.316.008.02-2	1,6	20 N-cm	7,3	2,7	5,15	5,9	1,4	2,2	conical	35°	45° Chamfer	Unigrip
40.316.012.01-2	1,6	20 N-cm	8	2,65	5,53	6	2	2,15	conical	45°	45° Chamfer	Star 1,50
40.316.014.01-2	1,6	20 N-cm	7,9	2,3	5,42	6,46	1,44	2,2	conical	20°	45° Chamfer	Hex. 1,19
40.317.002.01-2	N1-72	25 N-cm	8,17	3	5,31	5,87	2,3	2,4	conical	45°	45° Chamfer	Sq. 1,30
40.317.004.01-2	N1-72	25 N-cm	7,6	2,8	5,6	5,76	1,84	2,3	conical	70°	45° Chamfer	Hex. 1,27
40.317.004.02-2	N1-72	25 N-cm	7,52	2,2	5,12	5,773	1,75	2,1	conical	30°	45° Chamfer	Hex. 1,25
40.317.005.01-2	N1-72	25 N-cm	7,6	2,5	5,19	5,42	2,18	2,2	conical	60°	45° Chamfer	Hex. 1,27
40.317.005.02-2	N1-72	25 N-cm	7,2	2,4	4,73	5,25	1,95	2,4	conical	45°	45° Chamfer	Hex. 1,27
40.318.002.01-2	1,8	25 N-cm	7	3,2	5,2	-	1,8	2,5	straight	-	45° Chamfer	Sq. 1,30
40.318.002.02-2	1,8	25 N-cm	8,3	2,6	6,6	-	1,7	2,45	straight	-	45° Chamfer	Sq. 1,30
40.318.003.01-2	1,8	25 N-cm	6,8	3,3	5,2	-	1,6	2,3	straight	-	45° Chamfer	Hex. 1,20
40.318.003.02-2	1,8	25 N-cm	8	3,6	6	-	2	2,1	straight	-	45° Chamfer	Hex. 1,20
40.318.004.01-2	1,8	25 N-cm	7,2	4,47	2,3	6,2	1	2,4	conical	30°	45° Chamfer	Hex. 1,25
40.318.004.02-2	1,8	25 N-cm	9,8	5,094	8,3	8,8	1	2,4	conical	30°	45° Chamfer	Hex. 1,25
40.318.004.03-2	1,8	25 N-cm	7,65	3,3	5,17	5,75	1,9	2,4	conical	35°	45° Chamfer	Hex. 1,25
40.318.005.01-2	1,8	25 N-cm	4,5	2,3	2,8	2,9	1,6	2,35	conical	70°	45° Chamfer	Hex. 1,27
40.318.005.02-2	1,8	25 N-cm	7,6	3,8	5,8	6,05	1,55	2,35	conical	50°	45° Chamfer	Hex. 1,27
40.318.006.01-2	1,8	25 N-cm	6	3,18	3,5	3,85	2,15	2,4	conical	45°	45° Chamfer	Hex. 1,50
40.318.007.01-2	1,8	25 N-cm	9,1	4,25	7,22	7,45	1,65	2,18	conical	60°	45° Chamfer	Torx T6
40.318.008.01-2	1,8	25 N-cm	8,3	2,5	6,5	-	1,8	2,45	straight	-	45° Chamfer	Unigrip



STRAIGHT SCREWS TECHNICAL SPECIFICATIONS

REFERENCE	METRIC	TORQUE	TOTAL LENGTH	THREAD LENGTH	A LENGTH	B LENGTH	C LENGTH	HEAD DIAMETER	SEAT	ANGLE	THREAD ENTRY	CONNECTION
40.318.012.01-2	1,8	25 N-cm	7,25	2,4	4,93	5,25	2	2,15	conical	45°	45° Chamfer	Sq. 1,50
40.318.012.02-2	1,8	25 N-cm	8	2,6	5,68	6	2	2,15	conical	45°	45° Chamfer	Sq. 1,50
40.318.013.01-2	1,8	25 N-cm	8	2,5	6,01	6,7	1,3	2,2	conical	30°	45° Chamfer	Hex. 1,00
40.320.002.01-2	2	30 N-cm	5	3,06	3,26	3,5	1,5	2,49	conical	45°	45° Chamfer	Sq. 1,30
40.320.002.02-2	2	30 N-cm	7,45	3	5,7	5,9	1,5	2,4	conical	45°	45° Chamfer	Sq. 1,30
40.320.002.03-2	2	30 N-cm	10,2	3,15	8,4	-	1,8	2,45	straight	-	45° Chamfer	Sq. 1,30
40.320.003.01-2	2	30 N-cm	4,7	2,7	3,33	-	1,37	2,35	straight	-	45° Chamfer	Hex. 1,20
40.320.003.02-2	2	30 N-cm	7	3,25	5	-	2	2,4	straight	-	45° Chamfer	Hex. 1,20
40.320.003.03-2	2	30 N-cm	7,9	3,7	5,55	6,05	1,85	2,4	conical	45°	45° Chamfer	Hex. 1,20
40.320.003.04-2	2	30 N-cm	8,4	2,75	5,68	6,35	2,05	2,3	conical	45°	45° Chamfer	Hex. 1,20
40.320.003.05-2	2	30 N-cm	4,8	3,3	3,65	3,9	0,9	2,45	conical	45°	45° Chamfer	Hex. 1,20
40.320.005.01-2	2	30 N-cm	7,6	3,7	6	-	1,6	2,4	straight	-	45° Chamfer	Hex. 1,27
40.320.005.02-2	2	30 N-cm	10,3	4	8,3	-	2	2,45	straight	-	45° Chamfer	Hex. 1,27
40.320.005.03-2	2	30 N-cm	10,3	3,5	8,3	-	2	2,33	straight	-	45° Chamfer	Hex. 1,27
40.320.005.04-2	2	30 N-cm	10,5	3,06	8,15	8,4	2,1	2,5	conical	45°	45° Chamfer	Hex. 1,27
40.320.007.01-2	2	30 N-cm	6,7	2,25	3,59	5,7	1	2,58	conical	15°	45° Chamfer	Torx T6
40.320.007.02-2	2	30 N-cm	7,4	3,3	6	-	1,4	2,3	straight	-	Semi-sphere	Torx T6
40.320.007.03-2	2	30 N-cm	7,6	3	6,1	6,3	1,3	2,4	conical	45°	Semi-sphere	Torx T6
40.320.007.04-2	2	30 N-cm	4,5	2,96	3,21	3,5	1	2,45	conical	45°	45° Chamfer	Torx T6
40.320.008.01-2	2	30 N-cm	7	3,25	5	-	2	2,4	straight	-	45° Chamfer	Unigrip
40.320.008.02-2	2	30 N-cm	7,3	3	5,8	6,2	1,1	2,5	conical	35°	45° Chamfer	Unigrip
40.320.008.03-2	2	30 N-cm	10	3,6	8,5	-	1,5	2,45	straight	-	45° Chamfer	Unigrip
40.325.002.01-2	2,5	30 N-cm	7,41	3,5	4,75	5,29	2,12	2,87	conical	45°	Semi-sphere	Sq. 1,30
40.325.008.01-2	2,5	30 N-cm	7	2,8	5,6	-	1,4	3,4	straight	-	45° Chamfer	Unigrip

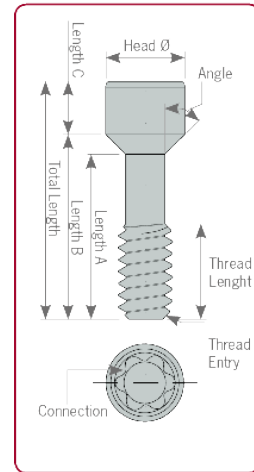
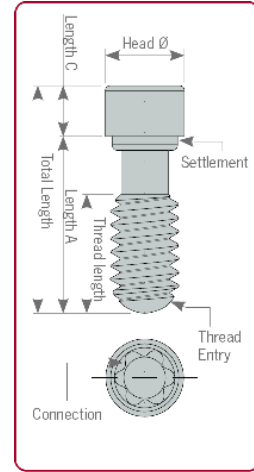

SCREWDRIVERS & STRAIGHT SCREWS

Screwdrivers

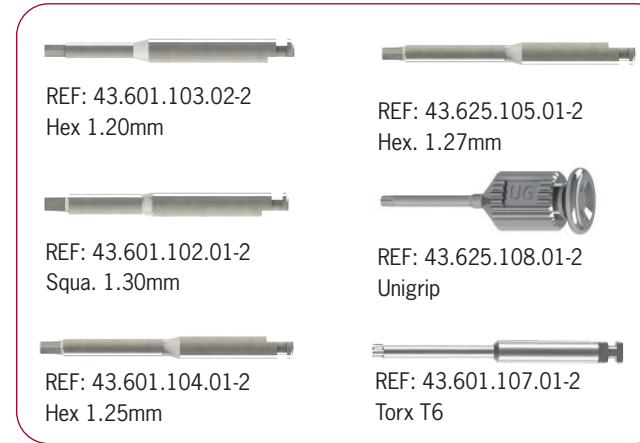

Straight screws cover all the thread metrics available on the market. We have several lengths for each metric to make the adaptation to the milled structures easier. Made of Titanium grade V.



Straight Screws

DYNAMIC SYSTEM SCANBODIES AND COLORS ACCORDING TO COMPATIBILITY

CONNECTION	LIBRARY CODE	SCANBODY TYPE	MIDDLE PIECE	MAGNET SCREW
Branemark RP	DAS_I_0024	SBIOHA10	N/A	45.320.079.01
Zimmer NP	DAS_I_0040		51.312.040.01	45.317.083.01
GH 3 Zimmer NP	DAS_IG_0040		51.312.040.03	45.317.113.01
NB Active RP	DAS_I_0022		51.313.022.01	45.320.091.01
GH 3 NB Active RP	DAS_IG_0022		51.313.022.03	45.320.116.01
Biomet 3i Certain RP	DAS_I_0002		51.313.002.01	45.316.100.01
GH 3 Biomet 3i Certain RP	DAS_IG_0002		51.313.002.04	45.316.128.01
Osstem TS RP	DAS_I_0030		51.313.030.01	45.320.091.01
GH 3 Osstem TS RP	DAS_IG_0030		51.313.030.03	45.320.116.01
GH 3 Osstem TS RP (Megagen)	DAS_IG_0030		51.313.030.03	45.320.121.01
Astra Evolution 4,2	DAS_I_0007		51.313.007.01	45.318.094.01
GH 3 Astra Evolution 4,2	DAS_IG_0007		51.313.007.03	45.318.124.01
MIS C1 RP	DAS_I_0017		51.313.017.01	45.317.088.01
GH3 MIS C1 RP	DAS_IG_0017		51.313.017.04	45.317.118.01
S&M Outlink 4,10	DAS_I_0064		N/A	45.320.079.01
Biomet 3i Certain WP	DAS_I_0057		51.313.002.01	45.316.100.01
GH 3 Biomet 3i Certain WP	DAS_IG_0057		51.313.002.04	45.316.128.01
GH 3 Neodent GM	DAS_IG_0186		51.313.186.04	45.316.128.01
Zimmer RP	DAS_I_0041	SBIOHB10	51.313.041.01	45.317.083.01
GH 3 Zimmer RP	DAS_IG_0041		51.313.041.03	45.317.113.01
Astra Lilac	DAS_I_0005		51.314.005.01	45.320.102.01
GH 3 Astra Lilac	DAS_IG_0005		51.314.005.03	45.320.129.01
Bego S/RI 4,5	DAS_I_0052		51.314.052.01	45.318.085.01
GH 3 Bego S/RI 4,5	DAS_IG_0052		51.314.052.04	45.318.125.01
Astra Evolution 4,8	DAS_I_0091		51.314.091.01	45.320.098.01
GH 3 Astra Evolution 4,8	DAS_IG_0091		51.314.091.03	45.320.125.01
MIS C1 WP	DAS_I_0018	51.314.018.01	45.317.092.01	
Branemark NP	DAS_I_0023	SBIOHC10	N/A	45.316.074.01
Astra Aqua	DAS_I_0004		51.313.004.01	45.316.081.01
GH 3 Astra Aqua	DAS_IG_0004		51.313.004.03	45.316.115.01
NB Active NP	DAS_I_0021		51.312.021.01	45.316.089.01
GH 3 NB Active NP	DAS_IG_0021		51.312.021.03	45.316.115.01
Biomet 3i Certain NP	DAS_I_0001		51.312.001.01	45.316.102.01
GH 3 Biomet 3i Certain NP	DAS_IG_0001		51.312.001.04	45.316.128.01
Osstem TS NP	DAS_I_0029		51.312.029.01	45.316.106.01

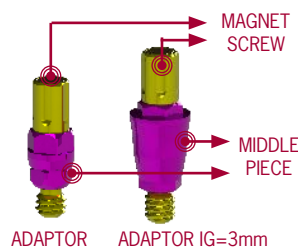

CONNECTION	LIBRARY CODE	SCANBODY TYPE	MIDDLE PIECE	MAGNET SCREW	
GH 3 Osstem TS NP	DAS_IG_0029	SBIOHD10	51.312.029.03	45.316.139.01	
Klockner Vega RV	DAS_I_0083		51.313.083.01	45.318.090.01	
Xive S 3,4	DAS_I_0038		51.312.038.01	45.316.100.01	
GH 3 Straumann BLX RB	DAS_IG_0207		51.310.207.03	45.316.115.01	
GH 3 Straumann BLX WB	DAS_IG_0208				
Biomet 3i Osseotite NP	DAS_I_0003	SBIOHE10	N/A	45.320.079.01	
Megagen AnyRidge RP	DAS_I_0015		51.313.015.01	45.318.082.01	
GH 3 Megagen AnyRidge RP	DAS_IG_0015		51.313.015.03	45.318.112.01	
S&M Premium Khono 3,30	DAS_I_0031		51.311.031.01	45.318.082.01	
SIC SICACE 3,3	DAS_I_0170		51.312.170.01	45.316.086.01	
GH 3 SIC SICACE 3,3	DAS_IG_0170		51.312.170.03	45.316.116.01	
GH 3 Global D In Kone NP	DAS_IG_0152		51.310.152.03	45.318.121.01	
Astra Evolution 3,6	DAS_I_0006		51.312.006.01	45.316.093.01	
GH 3 Astra Evolution 3,6	DAS_IG_0006		51.312.006.03	45.316.121.01	
MIS M4 NP	DAS_I_0019		51.312.019.01	45.316.084.01	
Klockner Vega NV	DAS_I_0082	51.312.082.01	45.316.089.01		
S&M Outlink 3,30	DAS_I_0063	N/A	45.318.065.01		
Keystone Prima NP	DAS_I_0044	51.312.044.01	45.318.076.01		
Ankylos CX	DAS_I_0075	51.312.075.01	45.318.092.01		
GH 3 Ankylos CX	DAS_IG_0075	51.312.075.13	45.318.123.01		
GH 3 SGS Dental CC	DAS_IG_0225	51.310.225.03	45.317.113.01		
GH 3 Paltop Advanced +	DAS_IG_0229	52.310.229.03	45.316.115.01		
Straumann Bone Level NP	DAS_I_0033	SBIOSA10	51.312.033.01	45.316.102.01	
GH 3 Straumann Bone Level NP	DAS_IG_0033		51.312.033.03	45.316.128.01	
MIS C1 NP	DAS_I_0016		51.312.016.01	45.316.084.01	
GH3 MIS C1 NP	DAS_IG_0016		51.312.016.04	45.316.113.01	
Dentium NR Line NP	DAS_I_0190		51.310.190.01	??	
GH 3 Dentium NR Line NP	DAS_IG_0190		51.310.190.03	??	
Straumann Bone Level RP	DAS_I_0035		SBIOSB10	51.313.035.01	45.316.106.01
GH 3 Straumann Bone Level RP	DAS_IG_0035			51.313.035.03	45.316.128.01
NB Replace 3,5	DAS_I_0026	SBIOA10	51.312.026.01	45.318.090.01	
GH 3 NB Replace 3,5	DAS_IG_0026		51.312.026.03	45.318.118.01	
Camlog Screw-Line 3,8	DAS_I_0011		51.312.011.01	45.316.118.01	
GH 3 Camlog Screw-Line 3,8	DAS_IG_0011	51.312.011.013	45.316.126.01		

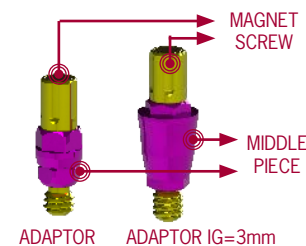

DYNAMIC SYSTEM SCANBODIES AND COLORS ACCORDING TO COMPATIBILITY

CONNECTION	LIBRARY CODE	SCANBODY TYPE	MIDDLE PIECE	MAGNET SCREW	
Conelog Screw-Line 3,8	DAS_I_0120	SBIOTB10	51.312.120.01	45.316.097.01	
NB Replace 4,3	DAS_I_0027		51.313.027.01	45.320.098.01	
GH 3 NB Replace 4,3	DAS_IG_0027		51.313.027.04	45.320.129.01	
Camlog Screw-Line 4,3	DAS_I_0012		51.313.012.01	45.316.118.01	
NB Replace 5,0	DAS_I_0028		51.314.028.01	45.320.098.01	
Conelog Screw-Line 4,3	DAS_I_0121		51.313.121.01	45.316.097.01	
GH 3 Conelog Screw-Line 4,3	DAS_IG_0121		51.313.121.03	45.316.126.01	
GH 3 Camlog Screw-Line 5,0	DAS_IG_0088		51.314.088.04	45.320.146.01	
GH 3 Camlog Screw-Line 6,0	DAS_IG_0088		51.314.088.04	45.320.146.01	
Straumann Synocta 4,8	DAS_I_0074		SBIIOA10	N/A	45.320.056.01
Straumann Oct. Interno 4,8	DAS_I_0037	51.313.037.01		45.320.091.01	
GH 3 Straumann Oct. Interno 4,8	DAS_IG_0037	51.313.037.04		45.320.121.01	
Straumann Oct. Interno 6,5	DAS_I_0096	51.314.096.01		45.320.095.01	
GH 3 Straumann Oct. Interno 6,5	DAS_IG_0096	51.314.096.04			
Multi Unit RP	DAS_I_0025	SBIOMA10	N/A	45.314.060.01	
NB Multi Unit RP	DAS_I_0025	SBIOMB8	N/A	45.314.040.01	
MIS Multi Unit St	DAS_I_0020		N/A	45.316.042.01	
Anthogyr Multi-Unit 4,8	DAS_I_0163		N/A	45.314.039.01	
Lasak Multi-Unit QN/QR	DAS_I_0168		N/A	45.314.039.01	
Zimmer Tapered Screw-Vent	DAS_I_0205		N/A	45.317.052.01	
Paltop MU	DAS_I_0181		N/A	45.318.039.01	
Astra Evolution Uni-Abutment	DAS_I_0008	SBIOHF8	N/A	45.318.048.01	
BTI External NP	DAS_I_0009	SBIOHG10	N/A	45.320.056.01	
Xive S 3,8	DAS_I_0039		51.313.039.01	45.316.100.01	
GH 3 Xive S 3,8	DAS_IG_0039		51.313.039.04		
Bego Mini	DAS_I_0187		N/A	45.316.074.01	
BTI Internal RP	DAS_I_0010	SBIOSC10	51.313.010.01	45.318.076.01	
BTI Internal WP					
GH 3 BTI Internal RP			DAS_IG_0010	51.313.010.04	45.318.103.01
GH 3 BTI Internal WP					
Bego RS/RX 3	DAS_I_0049	SBIOHH10	51.311.049.01	45.314.080.01	

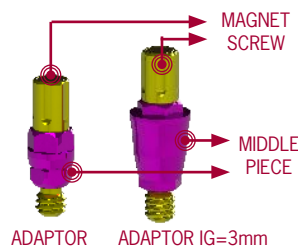

CONNECTION	LIBRARY CODE	SCANBODY TYPE	MIDDLE PIECE	MAGNET SCREW
Bego S/RI 3,25-3,75	DAS_I_0050	SBIOH10	51.312.050.01	45.318.082.01
GH 3 Bego S/RI 3,25-3,75	DAS_IG_0050		51.312.050.04	45.318.112.01
Medentis ICX-Templant 4,1	DAS_I_0125		51.313.125.01	45.316.100.01
GH 3 Medentis ICX-Templant 4,1	DAS_IG_0125		51.313.125.03	45.316.128.01
Xive S 4,5	DAS_I_0085		51.314.085.01	45.316.100.01
Alphabio Conical Std. Conn.	DAS_I_0169		51.312.169.01	45.317.092.01
GH 3 Alphabio Conical Std. Conn.	DAS_IG_0169		51.312.169.04	45.317.118.01
Lasak Bioniq QR	DAS_I_0167		51.313.167.01	45.316.100.01
GH 3 Lasak Bioniq QR	DAS_IG_0167		51.313.167.03	45.316.128.01
SIC SICACE 4,2	DAS_I_0171		51.313.171.01	45.316.086.01
GH 3 SIC SICACE 4,2	DAS_IG_0171		51.313.171.03	45.316.116.01
Bredent SKY NP	DAS_I_0110		51.310.110.01	45.318.094.01
Bredent SKY RP				
GH 3 Bredent SKY NP				
GH 3 Bredent SKY RP				
Bego S/RI 4,1	DAS_I_0051	SBIOHJ10	51.313.051.01	45.318.085.01
GH 3 Bego S/RI 4,1	DAS_IG_0051		51.313.051.04	45.318.112.01
Biomet 3i Osseotite WP	DAS_I_0058		N/A	45.320.079.01
Keystone Prima RP	DAS_I_0045		51.313.045.01	45.318.076.01
Klockner Essential Cone 4,5	DAS_I_0054	SBIOOB10	51.314.054.01	45.318.094.01
S&M Premium Khono 3,80	DAS_I_0032	SBIOHK10	51.312.032.01	45.318.076.01
S&M Premium Khono 4,25	DAS_I_0065	SBIOHL10	51.313.065.01	45.320.082.01
BTI External WP	DAS_I_0060	SBIOHM10	N/A	45.320.079.01
BTI Multi-IM Universal	DAS_I_0151	SBIOHN9	N/A	45.314.048.01
Neoss 3,4	DAS_I_0047		51.312.047.01	45.320.080.01
Neoss 4,1				
Zimmer WP	DAS_I_0080	SBIOHO10	51.314.080.01	45.317.083.01
NB Branemark WP	DAS_I_0061	SBIOHP10	N/A	45.325.075.01
NB Active WP	DAS_I_0124		51.314.124.01	45.320.091.01
GH 3 NB Active WP	DAS_IG_0124		51.314.124.03	45.320.116.01
Keystone Prima WP	DAS_I_0046		51.314.046.01	45.318.076.01
Bego S/RI 5,5	DAS_I_0081	SBIOHR10	51.315.081.01	45.318.090.01

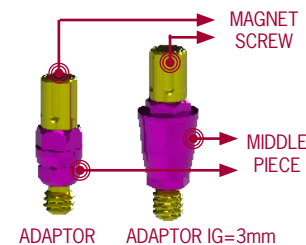

DYNAMIC SYSTEM SCANBODIES AND COLORS ACCORDING TO COMPATIBILITY

CONNECTION	LIBRARY CODE	SCANBODY TYPE	MIDDLE PIECE	MAGNET SCREW
Dentaurum Tiologic S	DAS_I_0130	SBIOPA10	51.312.130.01	45.316.093.01
Dentaurum Tiologic M	DAS_I_0131		51.313.131.01	45.316.093.01
Dentaurum Tiologic L	DAS_I_0132		51.314.132.01	45.316.093.01
Astra Evolution 3,0	DAS_I_0090	SBIOHS10	51.311.090.01	45.314.078.02
Astra Evolution 3,0	DAS_IG_0090		51.311.090.03	45.314.106.01
Astra Yellow	DAS_I_0109		51.312.109.01	45.314.072.02
NB Active 3,0	DAS_I_0159		51.310.159.01	45.314.078.01
Alphabio Conical Hex. Conn.	DAS_I_0136		51.310.136.01	45.316.075.01
GH 3 Alphabio Conical Hex. Conn.	DAS_IG_0136		51.310.136.04	45.316.103.01
Biotech Dental Kontakt XNP	DAS_I_0164		51.310.164.01	45.312.082.01
Biohorizons 3,0	DAS_I_0102		51.312.102.01	45.317.072.01
GH 3 Biohorizons 3,0	DAS_IG_0102		51.312.102.03	45.317.101.01
Lasak Bioniq QN	DAS_I_0166		51.310.166.01	45.314.086.01
GH 3 Lasak Bioniq QN	DAS_IG_0166		51.310.166.03	45.314.115.01
DIO UF NP	DAS_I_0014		51.312.014.01	45.314.072.01
GH 3 DIO UF NP	DAS_IG_0014		51.312.014.03	45.314.102.01
Adin Touareg/Closefit NP	DAS_I_0145		51.310.145.01	45.315.077.01
GH 3 Adin Touareg/Closefit NP	DAS_IG_0145		51.310.145.03	45.315.107.01
Adin Touareg/Closefit UNP	DAS_I_0188		51.310.188.01	45.315.077.01
GH 3 Adin Touareg/Closefit UNP	DAS_IG_0188		51.310.188.03	45.315.107.01
GH 3 SGS Dental Narrow CC	DAS_IG_0226		51.310.226.03	45.315.107.01
GH 3 Medentis ICX 3,3	DAS_IG_0249		51.310.249.03	45.314.115.01
Astra Evolution 5,4	DAS_I_0092		SBIOHT10	51.315.092.01
Astra Evolution 5,4	DAS_IG_0092	51.315.092.03		45.320.125.01
NB Replace 6,0	DAS_I_0129	SBIOTC10	51.315.129.01	45.320.098.01
Straumann Synocta 3,5	DAS_I_0160	SBIOSD10	51.310.160.01	45.316.090.01
GH 3 Straumann Bone Level 2,9	DAS_I_0235		51.310.235.03	45.314.115.01
Anthogyr Axiom REG/PX XNP	DAS_I_0161	SBIOTD10	51.310.161.01	45.316.090.01
Anthogyr Axiom REG/PX RP				
Anthogyr Axiom REG/PX WP				
Biotech Dental Kontakt RP	DAS_I_0165		51.313.165.01	45.314.095.01
GH 3 Camlog Screw-Line 3,3	DAS_IG_0087		51.311.087.04	45.316.147.01
GH 3 Conelog Screw-Line 3,3	DAS_IG_0119		51.311.119.03	45.316.122.01
Str. Screw-Retained NC/RC	DAS_I_0101	SBIODA10	N/A	45.314.060.01

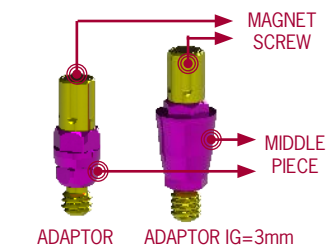
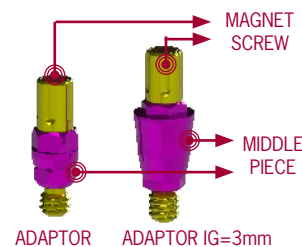

CONNECTION	LIBRARY CODE	SCANBODY TYPE	MIDDLE PIECE	MAGNET SCREW
Straumann Synocta 6,5	DAS_I_0137	SBIIOC10	N/A	45.320.056.01
Bego Multi-Plus	DAS_I_0150	SBIOMC9	N/A	45.314.039.02
Ankylos Balance Base	DAS_I_0183	SBIOMD8	N/A	45.316.057.01
DAS Multi-Unit	DAS_I_0209	SBIODASMU	N/A	45.320.052.01
Easy Implant Mini	DAS_I_0176	SBIOHU8	N/A	45.314.046.01

MAIN COMPATIBILITY	REFERENCE	CUTTING DIAMETER	SEAT	CUTTING LENGTH	USEFUL LENGTH (max. drilling depth)	STEM CUTTING DIAMETER	SUPPORT DIAMETER (SHANK)	TOTAL LENGTH
		ϕ_c	α	Lc	Lu	ϕ_v	ϕ_s	Lt
BEGO RS/RX 3* ASTRA EVOLUTION 3.0* * Only for titanium and soft materials	33.325.472.01-2	1,4	25	0,4	4,7	0,5	3	50
	33.425.472.01-2	1,4	25	0,4	4,7	0,5	4	50
	33.625.472.01-2	1,4	25	0,4	4,7	0,5	6	50
STRAUMANN BONE LEVEL NP STRAUMANN BONE LEVEL RP MEDENTIS ICX TEMPLANT 4,1 STRAUMANN SYNCOCTA 3.5 MEDENTIS ICX NARROW	33.315.804.01-2	1,6	15	0,7	8	0,65	3	50
	33.415.804.01-2	1,6	15	0,7	8	0,65	4	50
	33.615.804.01-2	1,6	15	0,7	8	0,65	6	50
ANTHOGRY AXIOM RG/PX XNP ANTHOGRY AXIOM RG/PX RP ANTHOGRY AXIOM RG/PX WP	33.320.704.01-2	1,6	20	0,7	7	0,8	3	50
	33.420.704.01-2	1,6	20	0,7	7	0,8	4	50
	33.620.704.01-2	1,6	20	0,7	7	0,8	6	50
ASTRA EVOLUTION 3.6 ANKYLOS ALPHABIO CONICAL STANDARD CONNECTION LASAK BIONIQ QR NEODENT GM ANKYLOS BALANCE BASE	33.330.734.01-2	1,6	30	0,7	7,3	0,8	3	50
	33.430.734.01-2	1,6	30	0,7	7,3	0,8	4	50
	33.630.734.01-2	1,6	30	0,7	7,3	0,8	6	50
NOBEL BIOCARE ACTIVE NP NOBEL BIOCARE ACTIVE 3.0 LASAK BIONIQ QN	33.335.754.01-2	1,6	35	0,7	7,5	0,65	3	50
	33.435.754.01-2	1,6	35	0,7	7,5	0,65	4	50
	33.635.754.01-2	1,6	35	0,7	7,5	0,65	6	50
OSSTEM TS NP CAMLOG SCREW LINE 3.8 NP CAMLOG SCREW LINE 4.3 RP KLOCKNER VEGA NV XIVE S 3,4 BIOTECH DENTAL KONTACT XNP BIOTECH DENTAL KONTACT RP DIO UF NP CAMLOG SCREWLINE 3,3	33.345.804.01-2	1,6	45	0,7	8	0,65	3	50
	33.445.804.01-2	1,6	45	0,7	8	0,65	4	50
	33.645.804.01-2	1,6	45	0,7	8	0,65	6	50
MIS C1 NP MIS M4 NP CONELOG 3,8 CONELOG 4,3 ASTRA YELLOW ALPHABIO CONICAL HEX CONNECTION	33.360.754.01-2	1,6	60	0,7	7,5	0,65	3	50
	33.460.754.01-2	1,6	60	0,7	7,5	0,65	4	50
	33.660.754.01-2	1,6	60	0,7	7,5	0,65	6	50
BIOMET 3i CERTAIN NP ASTRA AQUA	33.390.754.01-2	1,6	90	0,7	7,5	0,65	3	50
	33.490.754.01-2	1,6	90	0,7	7,5	0,65	4	50
	33.690.754.01-2	1,6	90	0,7	7,5	0,65	6	50
ASTRA EVOLUTION 4.2	33.350.775.01-2	1,7	50	0,7	7,7	0,8	3	50
	33.450.775.01-2	1,7	50	0,7	7,7	0,8	4	50
	33.650.775.01-2	1,7	50	0,7	7,7	0,8	6	50
BIOMET 3i CERTAIN RP NOBEL BIOCARE BRANEMARK NP NOBEL BIOCARE REPLACE NP MEGAGEN ANYRIDGE RP BIOMET 3i CERTAIN WP	33.390.805.01-2	1,7	90	0,7	8	0,65	3	50
	33.490.805.01-2	1,7	90	0,7	8	0,65	4	50
	33.690.805.01-2	1,7	90	0,7	8	0,65	6	50
BEGO S/RI 3,25-3,75 BEGO S/RI 4,1 BEGO S/RI 4,5 BEGO S/RI 5,50 STRAUMANN SCREW-RETAINED NC/RC BEGO MULTI-PLUS	33.335.676.01-2	1,8	35	1	6,7	0,9	3	50
	33.435.676.01-2	1,8	35	1	6,7	0,9	4	50
	33.635.676.01-2	1,8	35	1	6,7	0,9	6	50
KLOCKNER ESSENTIAL CONE 4.5 DIRECTO IMPLANTE KLOCKNER ESSENTIAL CONE 4.5 OCTACONE 12° KLOCKNER ESSENTIAL CONE 4.5 OCTACONE 25° KLOCKNER VEGA RV XIVE S 3,8 XIVE S 4,5 BIOHORIZONS 3,0 STRAUMANN SYNCOCTA 6,5 STRAUMANN BLX RB STRAUMANN BLX WB STRAUMANN TLX NT STRAUMANN TLX RT STRAUMANN TLX WT	33.345.856.01-2	1,8	45	1	8,5	0,9	3	50
	33.445.856.01-2	1,8	45	1	8,5	0,9	4	50
	33.645.856.01-2	1,8	45	1	8,5	0,9	6	50

DYNAMIC MILLING TOOL SPECIFICATIONS

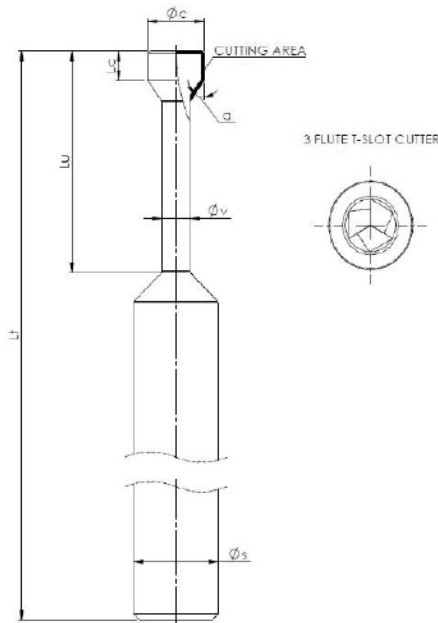

MAIN COMPATIBILITY	REFERENCE	CUTTING DIAMETER	SEAT	CUTTING LENGTH	USEFUL LENGTH (max. drilling depth)	STEM CUTTING DIAMETER	SUPPORT DIAMETER (SHANK)	TOTAL LENGTH
		ϕ_c	α	Lc	Lu	ϕ_v	ϕ_s	Lt
MIS C1 RP PALTOP UNIVERSAL MULTI UNIT MIS C1 WP S&M PREMIUM KHONO 3,3 S&M PREMIUM KHONO 3,8 S&M OUTLINK 3,3 S&M OUTLINK 4,1 S&M PREMIUM KHONO 4,25 BREDENT SKY NP BREDENT SKY RP ADIN TOUAREG/CLOSEFIT NP ADIN TOUAREG/CLOSEFIT UNP CAMLOG CONELO 3,3 GLOBAL D (TERKA) EASY IMPLANT MINI	33.360.756.01-2	1,8	60	1	7,5	0,9	3	50
	33.460.756.01-2	1,8	60	1	7,5	0,9	4	50
	33.660.756.01-2	1,8	60	1	7,5	0,9	6	50
ZIMMER SCREW-VENT 3.5 ZIMMER SCREW-VENT 4.5 ASTRA EVOLUTION UNIT ABUTMENT ZIMMER TYPE 5,7	33.370.716.01-2	1,8	70	1	7,1	0,9	3	50
	33.470.716.01-2	1,8	70	1	7,1	0,9	4	50
	33.670.716.01-2	1,8	70	1	7,1	0,9	6	50
NOBEL BIOCARE BRANEMARK RP NOBEL BIOCARE MULTHUNIT RP BIOMET 3i OSSEOTITE NP BTI EXTERNAL CONNECTION NP BTI INTERNAL CONNECTION NP MIS MULTI-UNIT ST KEYSTONE PRIMA NP KEYSTONE PRIMA RP KEYSTONE PRIMA WP NEOSS PROACTIVE 3,4 NEOSS PROACTIVE 4,1 BIOMET 3i OSSEOTITE WP BTI EXTERNAL CONNECTION WP BTI MULTH UNIVERSAL RP ANTHOGRYD MULTHUNIT 4.8 BEGO MINI BTI INTERNAL WP LASAK MULTI-UNIT QN/OR SIC SICACE 3,3 SIC SICACE 4,2	33.390.716.01-2	1,8	90	1	7,1	0,9	3	50
	33.490.716.01-2	1,8	90	1	7,1	0,9	4	50
	33.690.716.01-2	1,8	90	1	7,1	0,9	6	50
STRAUMANN INTERNAL OCTAGON RP STRAUMANN INTERNAL OCTAGON 6,5	33.315.708.01-2	2	15	1	7	1	3	50
	33.415.708.01-2	2	15	1	7	1	4	50
	33.615.708.01-2	2	15	1	7	1	6	50
STRAUMANN SYNCOCTA RP	33.330.708.01-2	2	30	1	7	1	3	50
	33.430.708.01-2	2	30	1	7	1	4	50
	33.630.708.01-2	2	30	1	7	1	6	50
NOBEL BIOCARE ACTIVE RP NOBEL BIOCARE ACTIVE WP	33.335.758.01-2	2	35	1	7,5	1	3	50
	33.435.758.01-2	2	35	1	7,5	1	4	50
	33.635.758.01-2	2	35	1	7,5	1	6	50
OSSTEM TS RP CAMLOG SCREWLINE 5,0 CAMLOG SCREWLINE 6,0	33.345.808.01-2	2	45	1	8	1	3	50
	33.445.808.01-2	2	45	1	8	1	4	50
	33.645.808.01-2	2	45	1	8	1	6	50
NOBEL BIOCARE REPLACE RP ASTRA LILAC NOBEL BIOCARE REPLACE WP ASTRA EVOLUTION 4.8 NOBEL BIOCARE BRANEMARK WP ASTRA EVOLUTION 5,4 NOBEL BIOCARE REPLACE 6.0	33.390.958.01-2	2	90	1	9,5	1	3	50
	33.490.958.01-2	2	90	1	9,5	1	4	50
	33.690.958.01-2	2	90	1	9,5	1	6	50

Reference code:

33.445.804.01-2
Cutting seat
Cutting diameter code
Shank
Useful length



DMTONE
DYNAMIC MILLING TOOL

SCREWDRIVER ADAPTOR



Screwdriver for the Dynamic µScanbody System

Ref. 43.621.410.01-2
Screwdriver with manual handle
Standard length: 21mm



Ref. 43.624.410.01-2
Contra-angle
Length: 24mm



Ref. 43.621.410.01-2
Contra-angle
Length: 30mm



Ref. 43.621.415.01-2
Tiny
Screwdriver with manual handle
Length: 21mm



Ref. 43.620.411.01-2
Multi Unit
Contra-angle
Length: 20 mm



COMPLEMENTS



Manual handle
Made of stainless steel.
They are used to connect screwdriver bits with the contra-angle connection

Large manual handle for laboratory Ref. 49.601.000.03-2
Ideal to manipulate models in the laboratory.
Length: 55.65mm.



Manual handle for clinic
Ref. 49.601.000.01-2
Clinic handle: used to position the prosthesis in the mouth prior to torque control in the clinic.
Length: 15.65mm.



Universal manual torque wrench prosthetic
Ref. 11.990.990.07-2
Torque wrench.
4mm square connection.
Torque 10-35N.c

Manual torque wrench adapter prosthetic
Piece to connect the screwdriver with contra-angle connection to the torque wrench.



Universal Manual torque wrench adapter
Ref. 49.604.000.05-2
4mm Square connection



Straumann Manual torque wrench adapter
Ref. 49.604.000.07-2
Straumann connection



Nobel Biocare Manual torque wrench adapter
Ref. 49.604.000.08-2

IDENTIFICATION PRODUCT

The label accompanying all Dynamic Abutment® Solutions products contains all the information the user requires. The product label contains detailed information of the contents of the blister pack. The symbols found on the identity labels correspond to the international product identification standards. All products are supplied with their corresponding instructions for use which include an explanation of each of the symbols found on the product label.

Identification of compliance with the requirements of applicable EC legislation

Refer to the instructions for use

Manufactured



Product reference
Batch Number
Quantity

Content information

Extended information

Human Readable Interpretation (HRI)

Date of manufacture

Non-reusable
Do not use if packaging is damaged
Non sterile product

SECURITY & TRACEABILITY

All of our products are patented and manufactured under very strict quality guidelines. With the 3.0 Dynamic System, we provide a card for the patient and labels for the laboratory and the clinic to identify the position in Dynamic System is located. We exercise complete control over the traceability of our products to fulfil the current health legislation. This helps repositioning the material and inform about the importance of using the appropriate tools when handling the Dynamic System components.

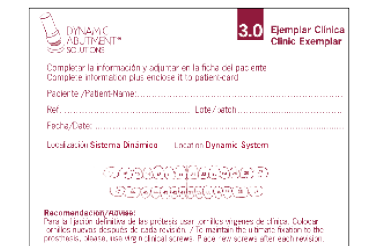
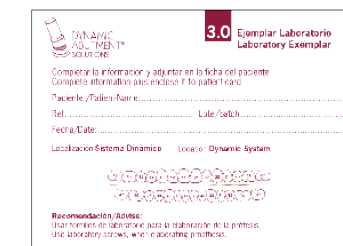
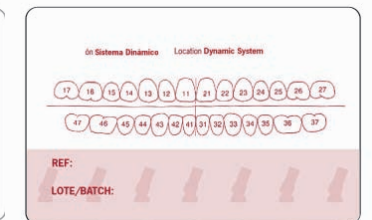

TALLADIUM GUARANTEE

TERMS AND CONDITIONS

These guarantee terms and conditions ("T&C") cover the entire range of Talladium products ("Products"), manufactured by TALLADIUM ESPAÑA S.L. and distributed by Geoda Medical S.L. or official dealers. The guarantee described in these T&C is exclusively in benefit of the clinician ("Clinician") and of the dental technician ("Technician") and not for the benefit of third parties or institutions, including patients.

GUARANTEE PERIOD

TALLADIUM ESPAÑA S.L. offers a lifelong guarantee for its entire range of products starting from the date of issue of the invoice.

GUARANTEE SCOPE

Subject to the limitations and exceptions described in these T&C, TALLADIUM ESPAÑA S.L. will offer the following benefits:

QUALITY: If there are defects in the materials or in the manufacturing of the Product, TALLADIUM ESPAÑA S.L. will replace the Product with no additional cost.

SAFETY: If, having complied with all the product indications, the prosthesis should have to be made again, due to a fault in the Dynamic Abutment® or Dynamic Titanium Base® system, TALLADIUM ESPAÑA S.L. will replace the abutments and screws necessary to remake the prosthesis, as well as the costs derived from its manufacturing.

In case of having used our products and having complied with all the product indications, the implants suffer any damage, TALLADIUM ESPAÑA S.L. will pay the cost of the implants. This coverage will only be valid during the first 6 months after the collocation of the prosthesis which includes our products.

CLAIM REQUIREMENTS AND PROCEDURE

To receive the benefits indicated in these T&C, the treating Clinician must satisfy the following requirements:

- The claim must be notified to TALLADIUM ESPAÑA S.L. within (30) days since the date the claimed defect was detected.
- This requires that the Clinician or Technician must contact the customer service department by telephone or by e-mail to make the claim.
- A claim form will be completed, which, together with a document or report which justifies the faulty Product and the faulty Product itself, will be sent by the customer to TALLADIUM ESPAÑA S.L. offices, within the previously indicated period.
- Clinicians or Technicians presenting a claim in agreement with these T&C must be up to date in any payments owing to TALLADIUM ESPAÑA S.L. or to any of its subsidiaries, at the time when the claim form is presented.
- All the use procedures of our Products must be carried out in agreement with the instructions of TALLADIUM ESPAÑA S.L. as well as in accordance with commonly accepted dentistry practices.
- The expenses derived from this procedure will be assumed by the customer. The return shipping costs will be assumed by TALLADIUM ESPAÑA S.L. in all those cases covered by these T&C.

Regardless of the guarantee rights, claims should be notified as soon as possible in order to comply with regulatory requirements.

GENERAL LIMITATIONS OF THIS GUARANTEE

With the exception of the guarantee described in these T&C, neither TALLADIUM ESPAÑA S.L. nor its representatives, nor third parties manufacturing or distributing the Products, represent or offer a guarantee, agreement or any other express or implicit, oral or written, commitment, with respect to the Products (without limitation), including guarantees involved in the marketing, durability or suitability for individual uses or purposes.

In addition and within the maximum extent permitted by the relative law, TALLADIUM ESPAÑA S.L. rejects (on its own behalf, and on behalf of its representatives and third parties that manufacture or distribute Products) any responsibility with respect to any direct or indirect damage caused, which may result from or be a consequence of the design, composition of the dental prosthesis into which the Products are integrated.

GUARANTEE EXCLUSIONS

TALLADIUM ESPAÑA S.L. limits this guarantee to:

- Transformed abutments that form part of the dental prosthesis. But not the screws used to anchor them.
- Clinical screws that have been in the mouth for more than 2 years.

AMENDMENT OR SUSPENSION OF THE GUARANTEE

TALLADIUM ESPAÑA S.L. reserves the right to amend or withdraw these T&C at any time and without prior notification. Any modification or suspension shall not affect products already placed in patients.

Ed.2019-01



VIRGINIA WOOLF, 17 · 25005 · LLEIDA (SPAIN)
INTERNATIONAL +34 973 289 580
das@dynamicabutment.com

SPAIN +34 973 289 580
spain@dynamicabutment.com

www.dynamicabutment.com



